



welding torch

MT221G
MT301G
MT401G
MT221G...X
MT301G...X
MT401G...X

099-500050-EW501

Observe additional system documents!

04.08.2016

**Register now
and benefit!**
**Jetzt Registrieren
und Profitieren!**

www.ewm-group.com



General instructions

WARNING



Read the operating instructions!

The operating instructions provide an introduction to the safe use of the products.

- Read and observe the operating instructions for all system components, especially the safety instructions and warning notices!
- Observe the accident prevention regulations and any regional regulations!
- The operating instructions must be kept at the site of operation.
- Safety and warning labels at the machine indicate any possible risks. Keep these labels clean and legible at all times.
- The machine has been constructed to the state of the art and any regulations and standards applicable. It may be operated, serviced and repaired by trained personnel only.



In the event of queries on installation, commissioning, operation or special conditions at the installation site, or on usage, please contact your sales partner or our customer service department on +49 2680 181-0.

A list of authorised sales partners can be found at www.ewm-group.com.

Liability relating to the operation of this equipment is restricted solely to the function of the equipment. No other form of liability, regardless of type, shall be accepted. This exclusion of liability shall be deemed accepted by the user on commissioning the equipment.

The manufacturer is unable to monitor whether or not these instructions or the conditions and methods are observed during installation, operation, usage and maintenance of the equipment. An incorrectly performed installation can result in material damage and injure persons as a result. For this reason, we do not accept any responsibility or liability for losses, damages or costs arising from incorrect installation, improper operation or incorrect usage and maintenance or any actions connected to this in any way.

© EWM AG

Dr. Günter-Henle-Str. 8

D-56271 Mündersbach, Germany

The copyright to this document remains the property of the manufacturer.

Reprinting, including extracts, only permitted with written approval.

The content of this document has been prepared and reviewed with all reasonable care. The information provided is subject to change, errors excepted.

1 Contents

1	Contents	3
2	Safety instructions	5
2.1	Notes on the use of these operating instructions	5
2.1.1	Explanation of icons	6
2.2	General	7
2.3	Transport.....	9
2.4	Scope of delivery	9
2.4.1	Ambient conditions	9
2.4.1.1	In operation	9
2.4.1.2	Transport and storage.....	9
3	Intended use	10
3.1	General	10
3.2	Documents which also apply	10
3.2.1	Warranty	10
3.2.2	Declaration of Conformity.....	10
3.2.3	Service documents (spare parts)	10
4	Product description – quick reference	11
4.1	Product variants.....	11
4.2	Standard welding torch	12
4.3	Function torch	13
4.3.1	Operating elements	14
4.3.2	Operating elements for up/down welding torch.....	14
4.3.3	Operating elements 2 for up/down welding torch.....	15
4.3.4	Operating elements for PC1 welding torch	16
4.3.5	Welding data display	17
4.3.6	Operating elements for PC2 welding torch	18
4.3.7	Welding data display	19
4.3.8	Euro central connection.....	20
4.3.9	Multimatrix Euro torch connector.....	20
4.4	Fume extraction torch	21
4.4.1	Fume extraction torch Euro torch connector	21
4.5	Equipment recommendations	22
5	Design and function	23
5.1	General	23
5.2	Configure welding torch	25
5.2.1	Turning the torch neck.....	25
5.2.2	Changing the torch neck	25
5.3	Adjusting the welding machine Euro torch connector.....	27
5.3.1	Preparation work on the euro torch connector to connect welding torches with plastic liners.....	27
5.3.2	Preparation work on the central connector to connect welding torches with spiral guides	27
5.4	Assemble the wire guide.....	27
5.4.1	Combined liner	28
5.4.2	Guide spiral	31
6	Maintenance, care and disposal	34
6.1	Maintenance work, intervals	34
6.1.1	Daily maintenance tasks	34
6.1.2	Monthly maintenance tasks.....	34
6.2	Maintenance work.....	34
6.3	Disposing of equipment	35
6.3.1	Manufacturer's declaration to the end user.....	35
6.4	Meeting the requirements of RoHS	35
7	Rectifying faults	36
7.1	Checklist for rectifying faults	36

7.2	Functional check PC1X – PC2X	38
8	Technical data.....	39
8.1	MT 221G/X, MT 301G/X, MT 401G/X,.....	39
9	Replaceable parts.....	40
9.1	MT221G	40
9.2	MT301G	42
9.3	MT401G	44
9.4	MT221G F / MT301G F.....	46
10	Circuit diagrams	47
10.1	MT U/D.....	47
10.2	MT U/DX.....	48
10.3	MT 2U/D.....	49
10.4	MT 2U/DX	50
10.5	MT PC1	51
10.6	MT PC1X.....	52
10.7	MT PC2	53
10.8	MT PC2X.....	54
11	Appendix A.....	55
11.1	Overview of EWM branches.....	55

2 Safety instructions

2.1 Notes on the use of these operating instructions

DANGER

Working or operating procedures which must be closely observed to prevent imminent serious and even fatal injuries.

- Safety notes include the "DANGER" keyword in the heading with a general warning symbol.
- The hazard is also highlighted using a symbol on the edge of the page.

WARNING

Working or operating procedures which must be closely observed to prevent serious and even fatal injuries.

- Safety notes include the "WARNING" keyword in the heading with a general warning symbol.
- The hazard is also highlighted using a symbol in the page margin.

CAUTION

Working or operating procedures which must be closely observed to prevent possible minor personal injury.























- The safety information includes the "CAUTION" keyword in its heading with a general warning symbol.
- The risk is explained using a symbol on the edge of the page.

 **Special technical points which users must observe.**

Instructions and lists detailing step-by-step actions for given situations can be recognised via bullet points, e.g.:

- Insert the welding current lead socket into the relevant socket and lock.

2.1.1 Explanation of icons

Symbol	Description	Symbol	Description
	Indicates technical aspects which the user must observe.		Activate and release/tap/tip
	Switch off machine		Release/do not activate
	Switch on machine		Press and hold
			switch
	Wrong		Turn
	Correct		Numerical value – adjustable
	Menu entry		Signal light lights up in green
	Navigating the menu		Signal light flashes green
	Exit menu		Signal light lights up in red
	Time representation (e.g.: wait 4 s/activate)		Signal light flashes red
	Interruption in the menu display (other setting options possible)		
	Tool not required/do not use		
	Tool required/use		

2.2 General

WARNING



Risk of injury from electrical voltage!

Voltages can cause potentially fatal electric shocks and burns on contact. Even low voltages can cause a shock and lead to accidents.

- Never touch live components such as welding current sockets or stick, tungsten or wire electrodes!
- Always place torches and electrode holders on an insulated surface!
- Wear the full personal protective equipment (depending on the application)!
- The machine may only be opened by qualified personnel!



Fire hazard!

Due to the high temperatures, sparks, glowing parts and hot slag that occur during welding, there is a risk of flames.

- Be watchful of potential sources of fire in the working area!
- Do not carry any easily inflammable objects, e.g. matches or lighters.
- Ensure suitable fire extinguishers are available in the working area!
- Thoroughly remove any residue of flammable materials from the workpiece prior to starting to weld.
- Only further process workpieces after they have cooled down. Do not allow them to contact any flammable materials!



Risk of injury due to radiation or heat!

Arc radiation results in injury to skin and eyes.

Contact with hot workpieces and sparks results in burns.

- Use welding shield or welding helmet with the appropriate safety level (depending on the application)!
- Wear dry protective clothing (e.g. welding shield, gloves, etc.) according to the relevant regulations in the country in question!
- Protect persons not involved in the work against arc beams and the risk of glare using safety curtains!



Risk of accidents due to non-compliance with the safety instructions!

Non-compliance with the safety instructions can be fatal!

- Carefully read the safety instructions in this manual!
- Observe the accident prevention regulations and any regional regulations!
- Inform persons in the working area that they must comply with the regulations!

CAUTION



Electromagnetic fields!

The power source may cause electrical or electromagnetic fields to be produced which could affect the correct functioning of electronic equipment such as IT or CNC devices, telecommunication lines, power cables, signal lines and pacemakers.



- Observe the maintenance instructions > see 6.1 chapter!
- Unwind welding leads completely!
- Shield devices or equipment sensitive to radiation accordingly!
- The correct functioning of pacemakers may be affected (obtain advice from a doctor if necessary).



Noise exposure!

Noise exceeding 70 dBA can cause permanent hearing damage!

- Wear suitable ear protection!
- Persons located within the working area must wear suitable ear protection!



Trained personnel!

Commissioning is reserved for persons who have the relevant expertise of working with arc welding machines.



This document is valid only in combination with the operating instructions for the product being used!

- **Read and observe the operating instructions for all system components, especially the safety instructions!**



Obligations of the operator!

The respective national directives and laws must be observed for operation of the machine!

- **National implementation of the framework directive (89/391/EWG), as well as the associated individual directives.**
- **In particular, directive (89/655/EWG), on the minimum regulations for safety and health protection when staff members use equipment during work.**
- **The regulations regarding work safety and accident prevention for the respective country.**
- **Setting up and operating the machine according to IEC 60974-9.**
- **Check at regular intervals that users are working in a safety-conscious way.**
- **Regular checks of the machine according to IEC 60974-4.**



The manufacturer's warranty becomes void if non-genuine parts are used!

- **Only use system components and options (power sources, welding torches, electrode holders, remote controls, spare parts and replacement parts, etc.) from our range of products!**
- **Only insert and lock accessory components into the relevant connection socket when the machine is switched off.**

2.3 Transport

CAUTION



Risk of accidents due to supply lines!

During transport, attached supply lines (mains leads, control cables, etc.) can cause risks, e.g. by causing connected machines to tip over and injure persons!

- Disconnect all supply lines before transport!

2.4 Scope of delivery

The delivery is checked and packaged carefully before dispatch, however it is not possible to exclude the possibility of damage during transit.

Receiving inspection

- Check that the delivery is complete using the delivery note!

In the event of damage to the packaging

- Check the delivery for damage (visual inspection)!

In the event of complaints

If the delivery has been damaged during transport:

- Please contact the last haulier immediately!
- Keep the packaging (for possible checking by the haulier or for the return shipment).

Packaging for returns

If possible, please use the original packaging and the original packaging material. If you have any queries on packaging and protection during transport, please contact your supplier.

2.4.1 Ambient conditions



Unusually high quantities of dust, acid, corrosive gases or substances may damage the equipment.

- ***Avoid high volumes of smoke, vapour, oil vapour and grinding dust!***
- ***Avoid ambient air containing salt (sea air)!***

2.4.1.1 In operation

Temperature range of the ambient air:

- -10 °C to +40 °C

Relative air humidity:

- Up to 50% at 40 °C
- Up to 90% at 20 °C

2.4.1.2 Transport and storage

Storage in an enclosed space, temperature range of the ambient air:

- -25 °C to +55 °C

Relative air humidity

- Up to 90% at 20 °C

3 Intended use

3.1 General

WARNING



Hazards due to improper usage!

The machine has been constructed to the state of the art and any regulations and standards applicable for use in industry and trade. It may only be used for the welding procedures indicated at the rating plate. Hazards may arise for persons, animals and material objects if the equipment is not used correctly. No liability is accepted for any damages arising from improper usage!

- The equipment must only be used in line with its designated purpose and by trained or expert personnel!
- Do not improperly modify or convert the equipment!

Welding torch for arc welding machines for GMAW.

3.2 Documents which also apply

3.2.1 Warranty



For more information refer to the "Warranty registration" brochure supplied and our information regarding warranty, maintenance and testing at www.ewm-group.com!

3.2.2 Declaration of Conformity



The labelled machine complies with the following EC directives in terms of its design and construction:

- Low Voltage Directive (LVD) 2014/35/EC
- Electromagnetic Compatibility Directive (EMC) 2014/30/EC
- Restriction of Hazardous Substance (RoHS) 2011/65/EC

In case of unauthorised changes, improper repairs, non-compliance with specified deadlines for "Arc Welding Equipment – Inspection and Testing during Operation", and/or prohibited modifications which have not been explicitly authorised by EWM, this declaration shall be voided. An original document of the specific declaration of conformity is included with every product.

3.2.3 Service documents (spare parts)

WARNING



Do not carry out any unauthorised repairs or modifications!

To avoid injury and equipment damage, the unit must only be repaired or modified by specialist, skilled persons!

The warranty becomes null and void in the event of unauthorised interference.

- Appoint only skilled persons for repair work (trained service personnel)!

Spare parts can be obtained from the relevant authorised dealer.

4 Product description – quick reference

4.1 Product variants

Version	Functions	Performance class
G	Gas-cooled	MT221, MT301, MT401
C	Interchangeable torch neck The welding torch can be equipped with a torch neck angled at 45°, 36° and 22°. The torch neck can be turned to the desired position.	MT221, MT301
F	Fume extraction torch The fume extraction torch features an extraction unit. The extraction capacity is infinitely adjustable using a slider.	MT221
U/D	Up/down torch The welding power (welding current/wire feed speed) or the program number can be adjusted on the welding torch.	MT221, MT301, MT401
2U/D	2 up/down torch The welding power (welding current/wire feed speed) and the voltage correction or the JOB number and program number can be adjusted on the welding torch.	MT221, MT301, MT401
PC1	POWERCONTROL1 welding torch The welding power (welding current/wire feed speed) or the program number can be adjusted on the welding torch. Values and changes are shown on the welding torch display.	MT221, MT301, MT401
PC2	POWERCONTROL2 welding torch The welding power (welding current/wire feed speed) and the voltage correction or the JOB number and program number can be adjusted on the welding torch. Values and changes are shown on the welding torch display.	MT221, MT301, MT401
X	X technology (Multimatrix) Welding torch with X technology – MT function torch without separate control cable	MT221, MT301, MT401



The extended functions for MT221G...X, MT301G...X, MT401G...X welding torches are only available if the welding torches on EWM machines are connected to the following control:

M3.70-A Phoenix Expert

M3.71-A Phoenix Progress

M3.72-A alpha Q Progress

M3.76-A Taurus Synergic S

M3.7X-A drive 4X HP

M3.7X-A drive 4X LP

4.2 Standard welding torch

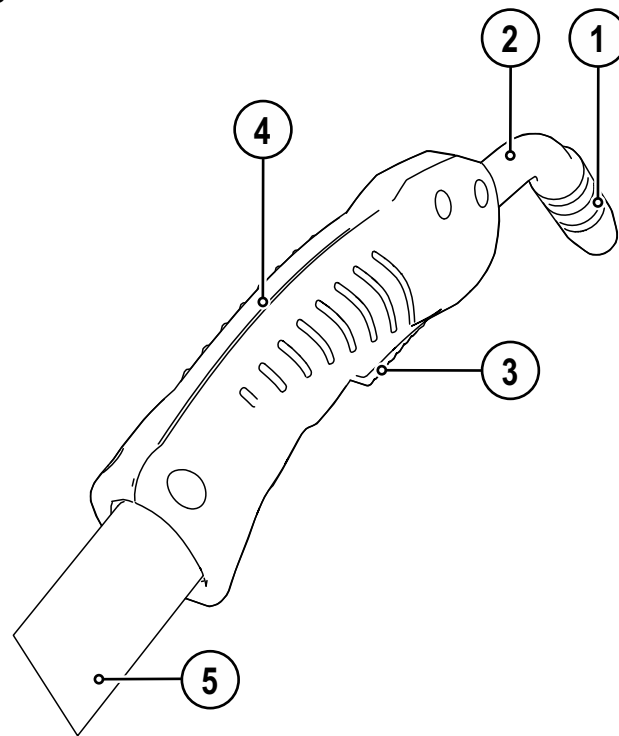

Figure 4-1

Item	Symbol	Description
1		Gas nozzle
2		Torch neck 45°
3		Torch trigger
4		Grip plate
5		Welding torch hose package

4.3 Function torch

Figure 4-2

Item	Symbol	Description
1		Gas nozzle
2		Torch neck 45°
3		Operating elements
4		Grip plate
5		Torch trigger
6		Welding torch hose package

4.3.1 Operating elements

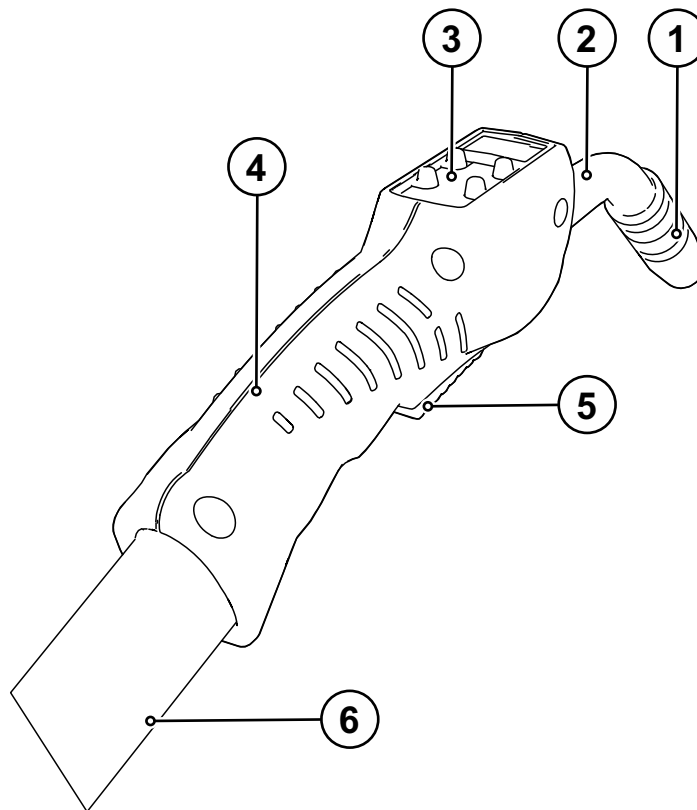
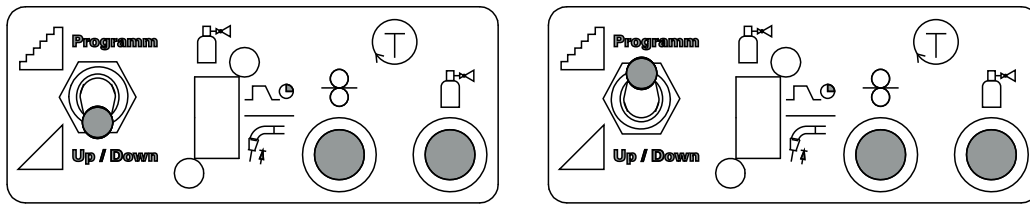

Figure 4-3

- Switch the "Program or up/down mode" changeover switch at the welding machine to the up/down or program mode position (see chapter "Design and function").

The 'Program or up/down function' changeover switch may look different on your machine. Use the operating instructions for your power source to operate the switch.

4.3.2 Operating elements for up/down welding torch

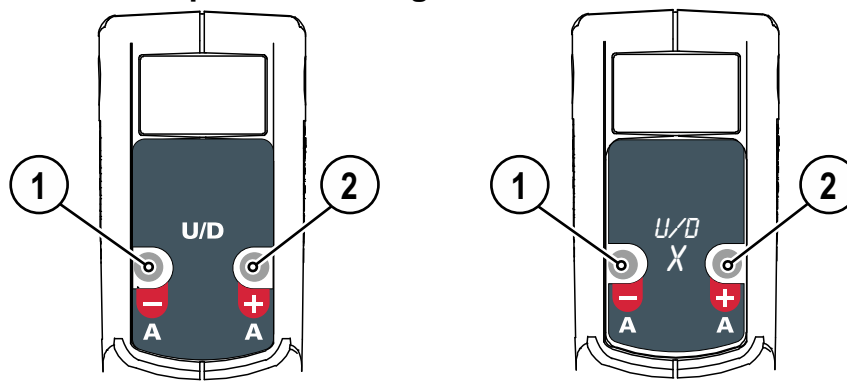

Figure 4-4

Item	Symbol	Description
1		"A -" button (Program mode) Decrease program number "A -" button (Up/Down mode) Reduce welding performance (welding current/wire-feed speed)
2		"A +" button (Program mode) Increase program number "A +" button (Up/Down mode) Increase welding performance (welding current/wire-feed speed)

4.3.3 Operating elements 2 for up/down welding torch

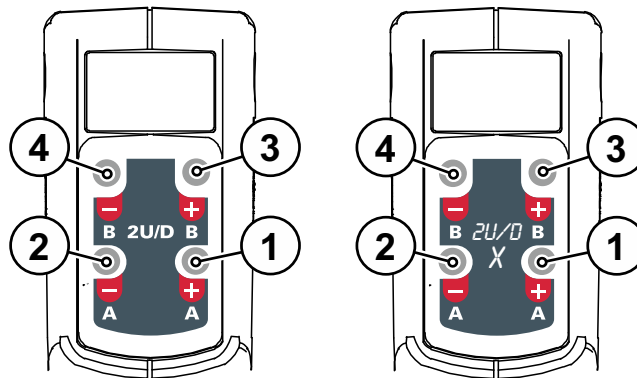

Figure 4-5

Item	Symbol	Description
1		"A +" button (Program mode) Increase program number "A +" button (Up/Down mode) Increase welding performance (welding current/wire-feed speed)
2		"A -" button (Program mode) Decrease program number "A -" button (Up/Down mode) Reduce welding performance (welding current/wire-feed speed)
3		"B +" button (program mode) Increase JOB number "B +" button (up/down mode) Welding voltage correction, increase value
4		"B -" button (program mode) Decrease JOB number "B -" button (up/down mode) Welding voltage correction, decrease value

4.3.4 Operating elements for PC1 welding torch

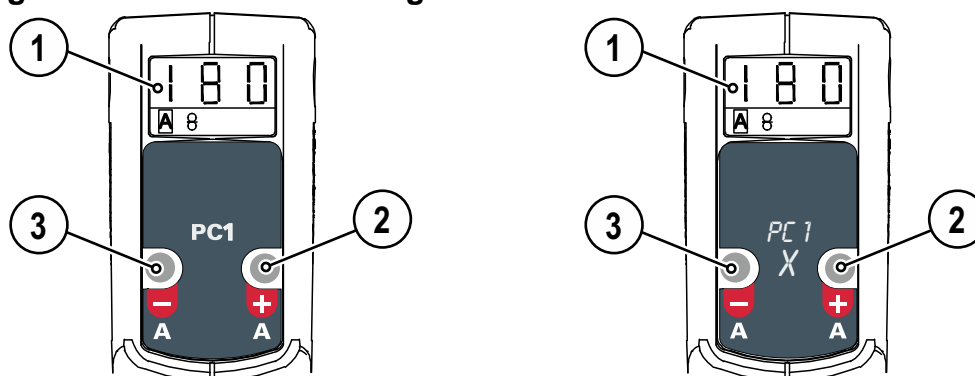

Figure 4-6

Item	Symbol	Description
1		Three-figure display Display of welding parameters > see 4.3.5 chapter.
2		"A +" button (Program mode) Increase program number "A +" button (Up/Down mode) Increase welding performance (welding current/wire-feed speed)
3		"A -" button (Program mode) Decrease program number "A -" button (Up/Down mode) Reduce welding performance (welding current/wire-feed speed)

4.3.5 Welding data display

The signal lamps in the lower part of the torch display indicate the welding parameters currently selected. The corresponding parameter value is shown on the three-digit display.

After the welding machine is switched on, the active JOB number is shown on the display for approx. 3 seconds. The display then switches to the setpoint value for the welding current or wire speed.

In up/down mode, the corresponding parameter value is shown on the display for parameter changes. If this parameter is not changed for approx. 5 seconds, the display switches back to the values specified by the machine control.

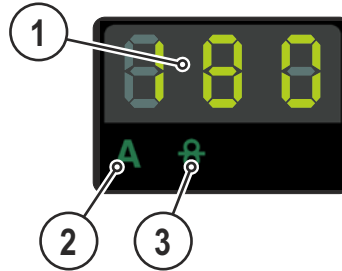

Figure 4-7

Item	Symbol	Description
1		Three-figure display Display of welding parameters > see 4.3.5 chapter.
2	A	Welding current display signal lamp
3		Wire speed display signal lamp

Example displays for welding parameters in the welding data display

Welding parameters	Display
Welding current	
Wire speed	
Programs	

4.3.6 Operating elements for PC2 welding torch

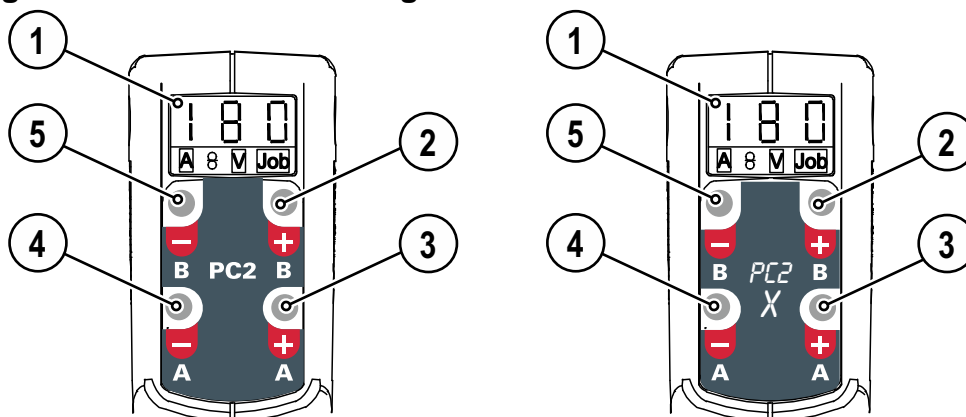

Figure 4-8

Item	Symbol	Description
1		Three-figure display Display of welding parameters > see 4.3.5 chapter.
2		"B +" button (program mode) Increase JOB number "B +" button (up/down mode) Welding voltage correction, increase value
3		"A +" button (Program mode) Increase program number "A +" button (Up/Down mode) Increase welding performance (welding current/wire-feed speed)
4		"A -" button (Program mode) Decrease program number "A -" button (Up/Down mode) Reduce welding performance (welding current/wire-feed speed)
5		"B -" button (program mode) Decrease JOB number "B -" button (up/down mode) Welding voltage correction, decrease value

4.3.7 Welding data display

The signal lamps in the lower part of the torch display indicate the welding parameters currently selected. The corresponding parameter value is shown on the three-digit display.

After the welding machine is switched on, the active JOB number is shown on the display for approx. 3 seconds. The display then switches to the setpoint value for the welding current or wire speed.

In up/down mode, the corresponding parameter value is shown on the display for parameter changes. If this parameter is not changed for approx. 5 seconds, the display switches back to the values specified by the machine control.

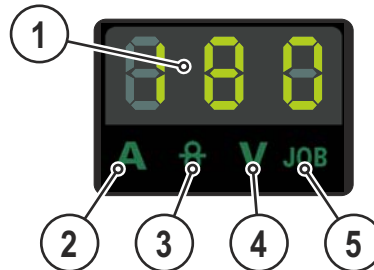

Figure 4-9

Item	Symbol	Description
1		Three-figure display Display of welding parameters > see 4.3.7 chapter.
2	A	Welding current display signal lamp
3		Wire speed display signal lamp
4	V	Voltage correction display signal lamp
5	JOB	JOB number display signal lamp

Example displays for welding parameters in the welding data display

Welding parameters	Display
Welding current	
Wire speed	
Voltage correction	
Programs	
JOB number	

4.3.8 Euro central connection

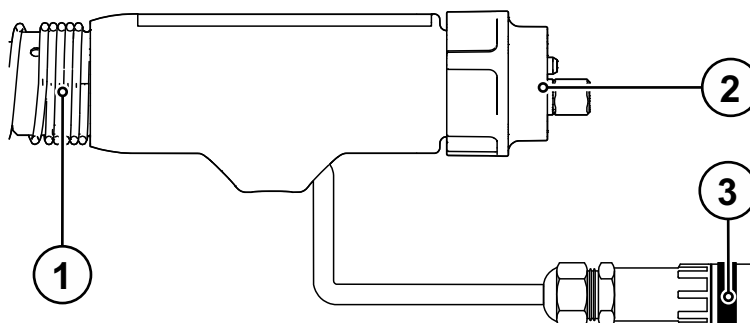



Figure 4-10

Item	Symbol	Description
1		Anti-kink spring
2		Euro central connection
3		Control cable plug With function torches only

4.3.9 Multimatrix Euro torch connector

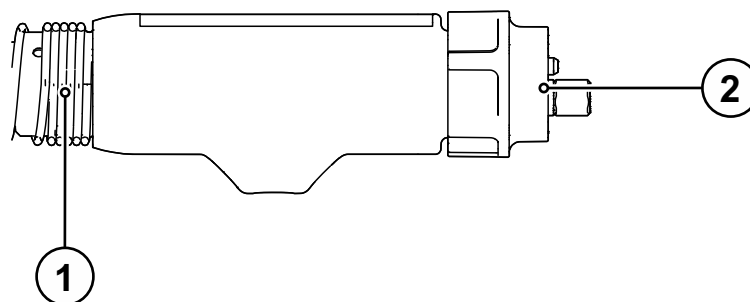



Figure 4-11

Item	Symbol	Description
1		Anti-kink spring
2		Euro central connection Welding current, shielding gas and torch trigger included

4.4 Fume extraction torch

Figure 4-12

Item	Symbol	Description
1		Gas nozzle
2		Extraction unit
3		Slider, extraction capacity
4		Torch trigger
5		Grip plate
6		Extraction hose

4.4.1 Fume extraction torch Euro torch connector

Figure 4-13

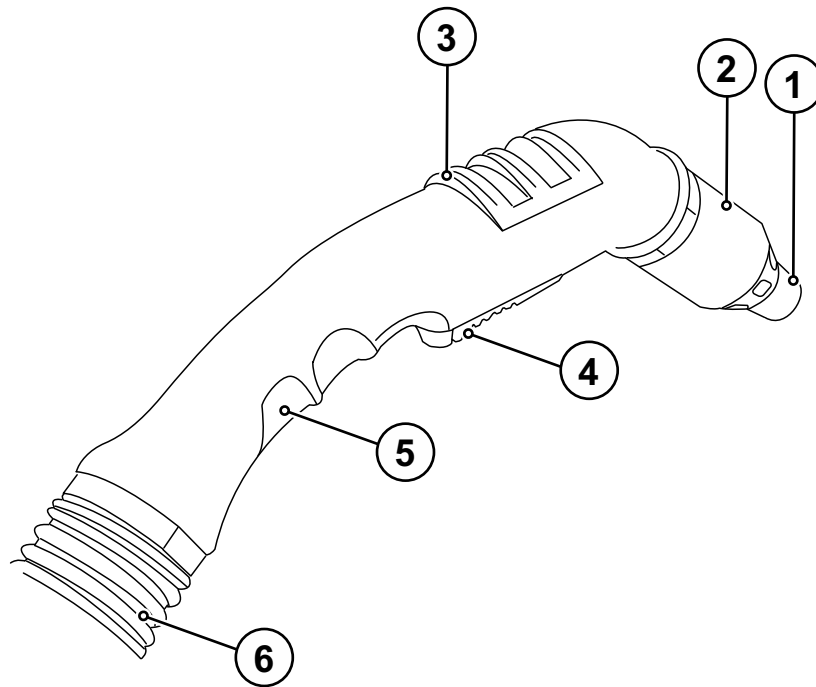
Item	Symbol	Description
1		Anti-kink spring
2		Connection, extraction unit Connect to extraction device or central extraction unit □ = 42.5 mm
3		Euro central connection

4.5 Equipment recommendations

	Material	Dia- meter wire	Contact tip	Dimension liner	Liner	Length brass spiral	Wire guide equipment	Wire feed roller	
GMAW Solid Wire	Un-alloyed	0,8	EWM CuCrZr	1,5 x 4,0	Steel liner insulated	/	① Euro torch connector	V groove	capillary tube
		1,0		1,5 x 4,0					
		1,2		2,0 x 4,0					
		1,6		2,4 x 4,5					
	Medium-alloyed	0,8	EWM CuCrZr	1,5 x 4,0	PA combi liner	200 mm	Euro torch connector	V groove	guide tube
		1,0		1,5 x 4,0					
		1,2		2,0 x 4,0					
		1,6		2,3 x 4,7					
	Hardfacing	0,8	EWM CuCrZr	1,5 x 4,0	PA combi liner	200 mm	Euro torch connector	V groove	guide tube
		1,0		1,5 x 4,0					
		1,2		2,0 x 4,0					
		1,6		2,3 x 4,7					
	Stainless Steel	0,8	EWM CuCrZr	1,5 x 4,0	PA combi liner	200 mm	Euro torch connector	V groove	guide tube
		1,0		1,5 x 4,0					
		1,2		2,0 x 4,0					
		1,6		2,3 x 4,7					
Aluminium	0,8	EWM Alu E-Cu	1,5 x 4,0	PA combi liner	30 mm	② Torch neck	U groove	guide tube	
	1,0		1,5 x 4,0						
	1,2		2,0 x 4,0						
	1,6		2,3 x 4,7						
Copper	0,8	EWM CuCrZr	1,5 x 4,0	PA combi liner	200 mm	Euro torch connector	V groove	guide tube	
	1,0		1,5 x 4,0						
	1,2		2,0 x 4,0						
	1,6		2,3 x 4,7						
FCAW Flux Cored Wire	Un-alloyed	0,8	EWM CuCrZr	1,5 x 4,0	Steel liner insulated	/	Euro torch connector	knurled V groove	capillary tube
		1,0		1,5 x 4,0					
		1,2		2,0 x 4,0					
		1,6		2,4 x 4,5					
	Stainless Steel	0,8	EWM CuCrZr	1,5 x 4,0	PA combi liner	200 mm	Euro torch connector	knurled V groove	guide tube
		1,0		1,5 x 4,0					
		1,2		2,0 x 4,0					
		1,6		2,3 x 4,7					

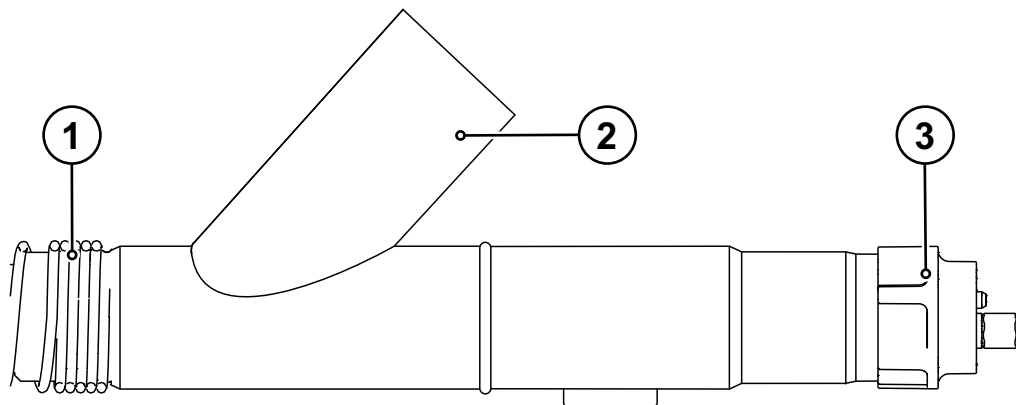
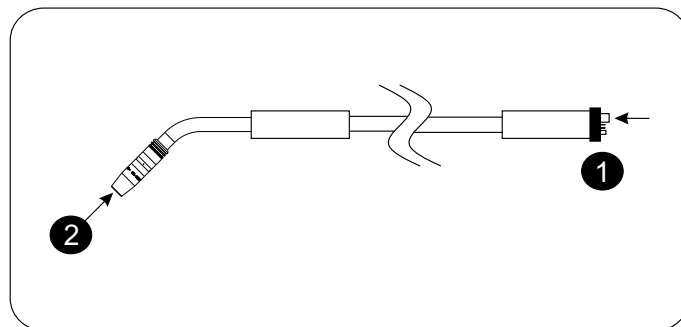
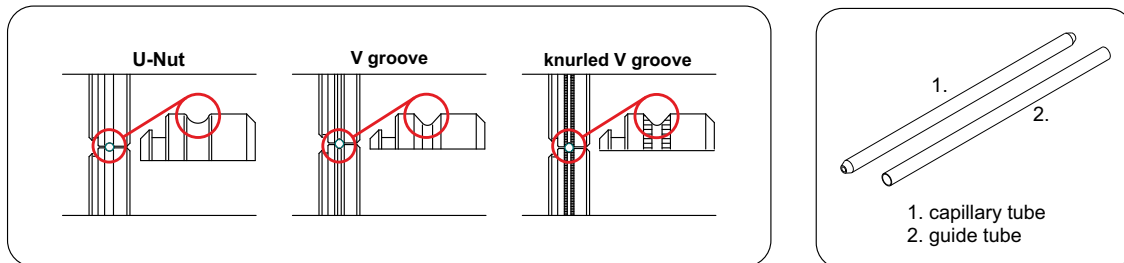

Figure 4-14

5 Design and function

5.1 General

WARNING



Risk of injury from electric shock!

Contact with live parts, e.g. welding current sockets, is potentially fatal!

- Follow safety instructions on the opening pages of the operating instructions.
- Commissioning may only be carried out by persons who have the relevant expertise of working with arc welding machines!
- Connection and welding leads (e.g. electrode holder, welding torch, workpiece lead, interfaces) may only be connected when the machine is switched off!

CAUTION



Risk of injury due to moving parts!

The wire feeders are equipped with moving parts, which can trap hands, hair, clothing or tools and thus injure persons!

- Do not reach into rotating or moving parts or drive components!
- Keep casing covers or protective caps closed during operation!





Risk of injury due to welding wire escaping in an unpredictable manner!

Welding wire can be conveyed at very high speeds and, if conveyed incorrectly, may escape in an uncontrolled manner and injure persons!

- Before mains connection, set up the complete wire guide system from the wire spool to the welding torch!
- Remove the pressure rollers from the wire feeder if no welding torch is fitted!
- Check wire guide at regular intervals!
- Keep all casing covers or protective caps closed during operation!

-  **Accessory components and the power source itself can be damaged by incorrect connection!**
 - **Only insert and lock accessory components into the relevant connection socket when the machine is switched off.**
 - **Comprehensive descriptions can be found in the operating instructions for the relevant accessory components.**
 - **Accessory components are detected automatically after the power source is switched on.**

-  **Protective dust caps protect the connection sockets and therefore the machine against dirt and damage.**
 - **The protective dust cap must be fitted if there is no accessory component being operated on that connection.**
 - **The cap must be replaced if faulty or if lost!**

-  **Observe documentation of other system components when connecting!**

5.2 Configure welding torch

5.2.1 Turning the torch neck

 **This function is only available with the "CG" and "CW" version!**

- Unfasten the crown nut by several turns from the handle until the torch neck can move freely.
- Rotate the torch neck into the required position.
- Tighten the crown nut hand-tight until the torch neck can no longer be moved.

5.2.2 Changing the torch neck

WARNING



Risk of burning or electric shock at the torch neck!

The torch neck and coolant (with water-cooled machines) become very hot during welding.



You may get into contact with hot components or voltage when turning or changing the torch neck.

- Switch off the power source and let the torch cool down!
- Wear dry and undamaged protective clothing (shoes with rubber soles/welder's gloves made from leather without any studs or braces)!

Welding torches can be fitted with a 45°, 36°, 22° and 0° angled torch neck as an option. To replace the torch neck follow these instructions.

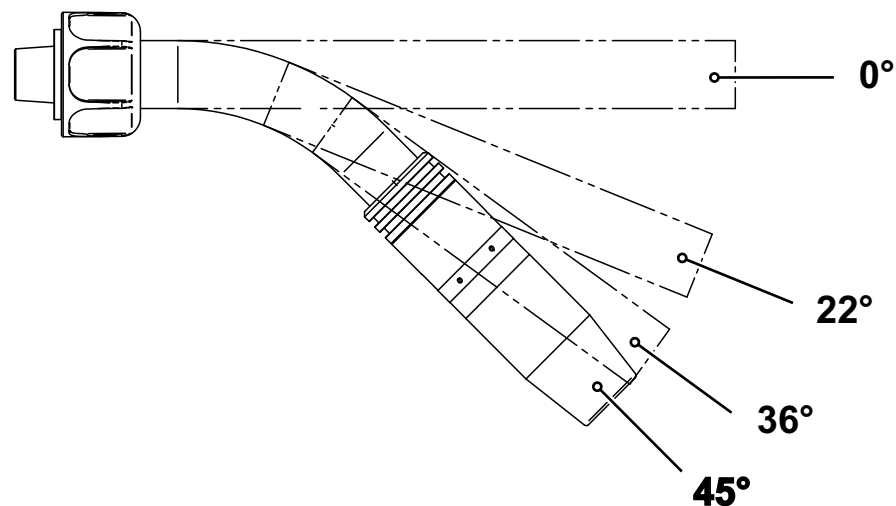

Figure 5-1

Switch off the welding machine before unfastening the torch neck!

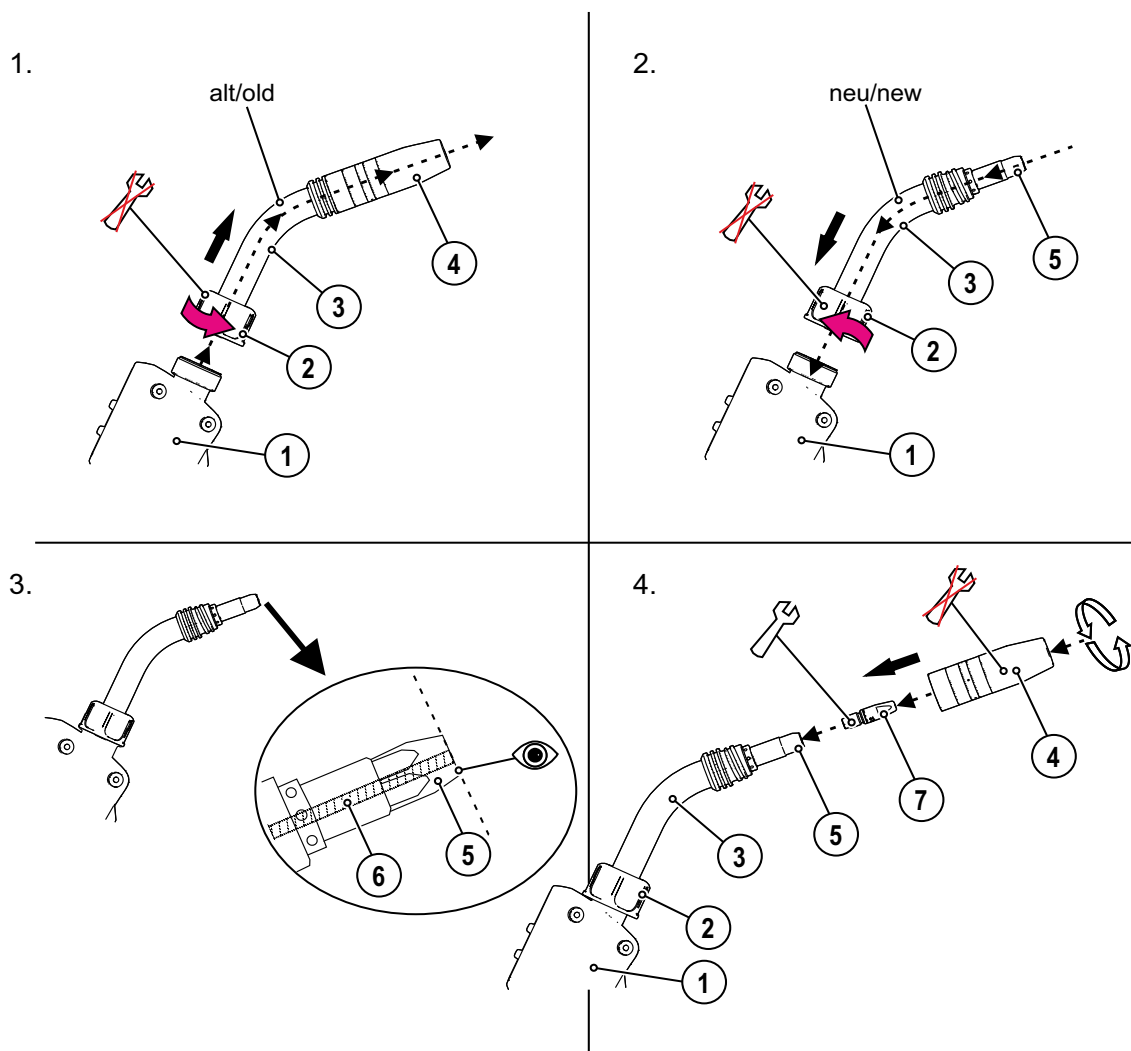

Figure 5-2

Item	Symbol	Description
1		Grip plate
2		Crown nut
3		Torch neck 45°
4		Gas nozzle
5		Contact tip holder
6		Liner
7		Contact tip

Re-connect the welding torch after completing any maintenance work, use the 'gas test' function to purge with shielding gas and vent.

5.3 Adjusting the welding machine Euro torch connector

 ***On delivery, the Euro torch connector is fitted with a capillary tube for welding torches with steel liners!***

5.3.1 Preparation work on the euro torch connector to connect welding torches with plastic liners

- Push forward the capillary tube on the wire feed side in the direction of the euro torch connector and remove at that point.
- Push on the guide pipe from the euro torch connector.
- Carefully insert the central plug for the welding torch, with the still oversized plastic core, into the euro torch connector and screw together with crown nut.
- Use a special cutter or sharp knife to cut off the plastic core shortly before the wire feed roller, making sure not to pinch it.
- Unfasten and remove the central plug on the welding torch.
- Cleanly remove the burr from the separated end of the plastic core!

5.3.2 Preparation work on the central connector to connect welding torches with spiral guides



- Check that the capillary tube is correctly positioned in relation to the central connector!
- Insert the central plug for the welding torch into the central connector and screw together with crown nut.

5.4 Assemble the wire guide

 ***Use the correct wire guide from spool to molten pool!***
The wire guide has to be adjusted to the wire electrode type and diameter in order to achieve good welding results!

- ***Equip the wire feeder according to wire electrode type and diameter!***
- ***Refer to the manufacturer instructions for the right wire feed unit equipment. Refer to Annex 1 in these operating instructions for the right EWM machine equipment.***
- ***Use a steel liner inside the torch hose package to guide hard, unalloyed wire electrodes (steel)!***
- ***Use a plastic liner inside the torch hose package to guide soft or alloyed wire electrodes!***

5.4.1 Combined liner

-  **A steel liner is installed at the connection side, whereas a combined liner is installed at the torch side.**
-  **The distance between the plastic liner and drive rollers should be as short as possible. Use only sharp, stable knives or special tongs for cutting to ensure that the plastic liner does not become misshapen!**
-  **Always make sure the the hose package is straight when replacing the wire guide.**

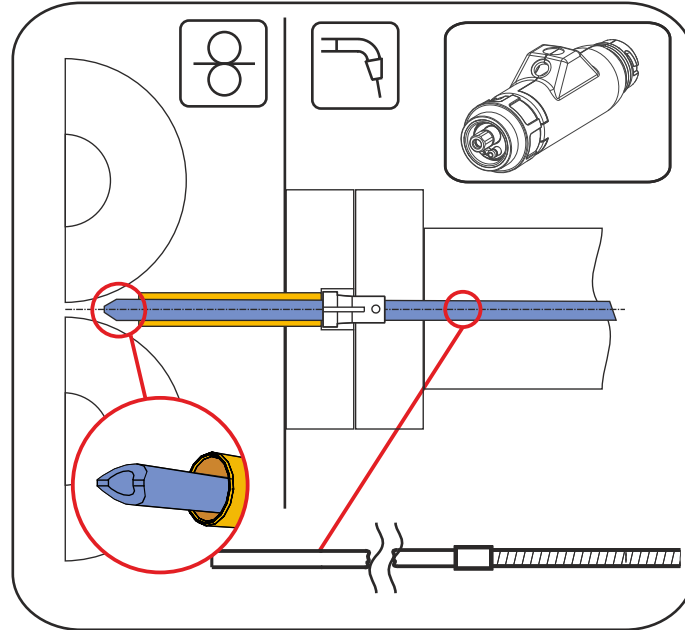

Figure 5-3

1.

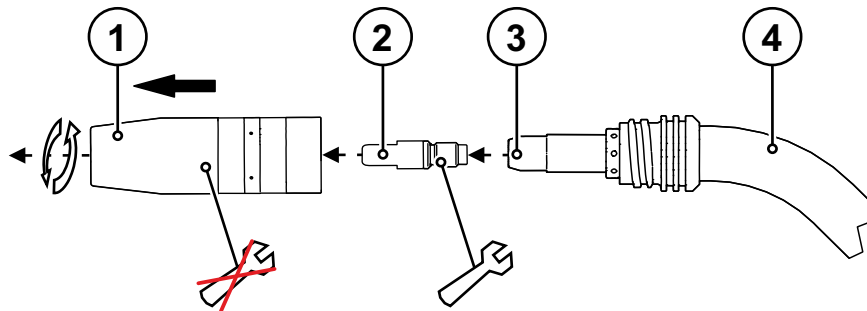

Figure 5-4

2.

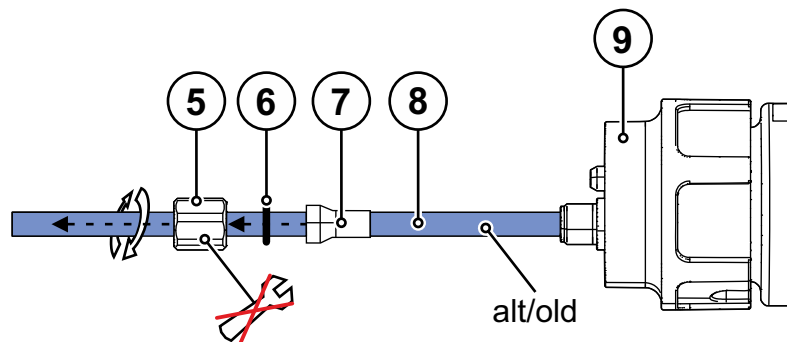

Figure 5-5

3.

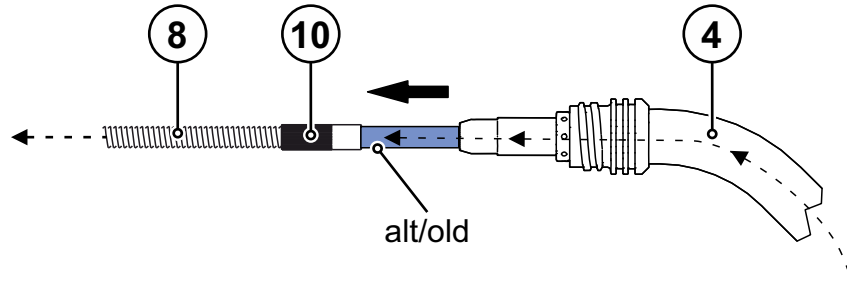

Figure 5-6

4.

Adjust steel liner > see 4.5 chapter.

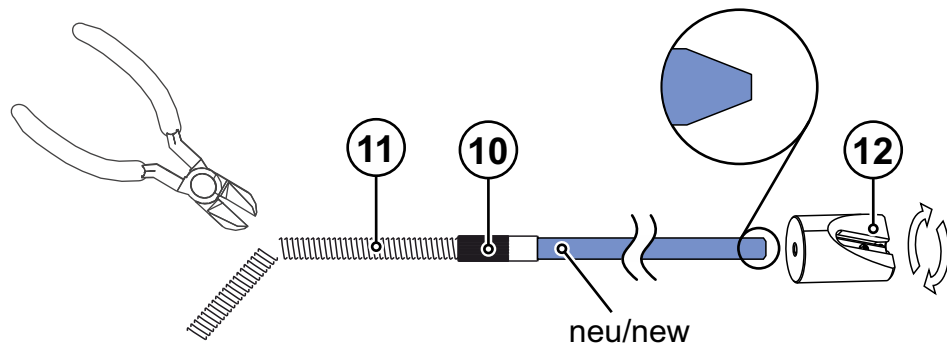

Figure 5-7

5.

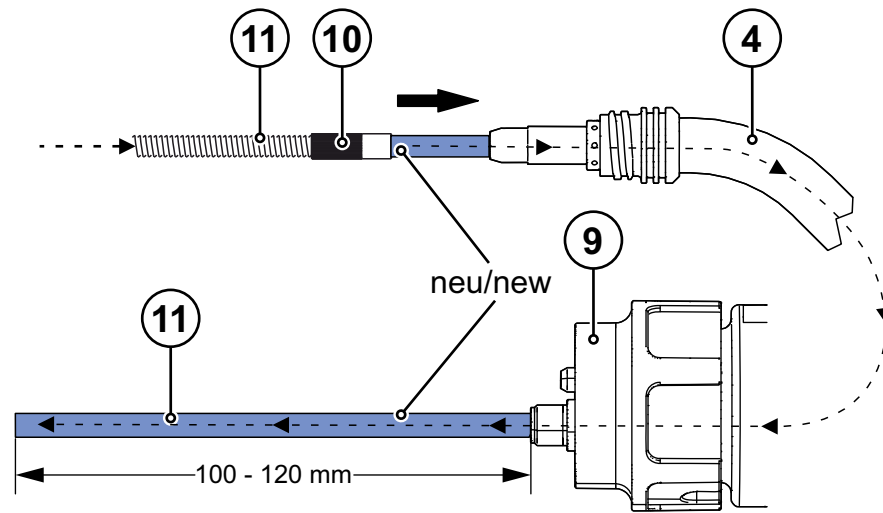

Figure 5-8

6.

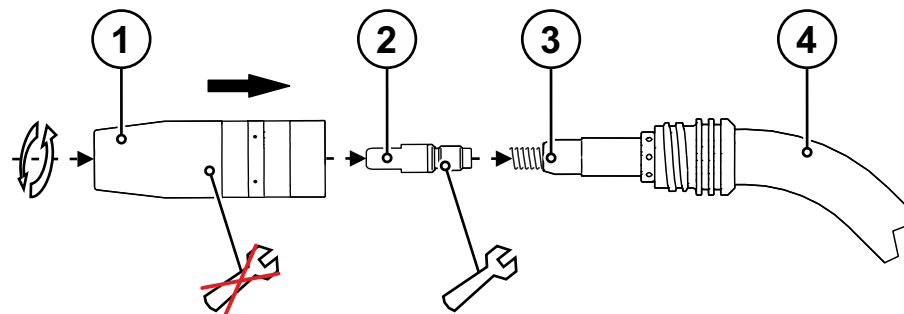

Figure 5-9

7.

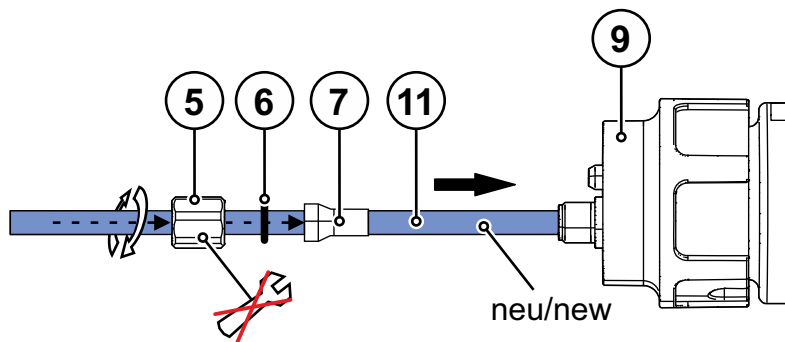

Figure 5-10

8.

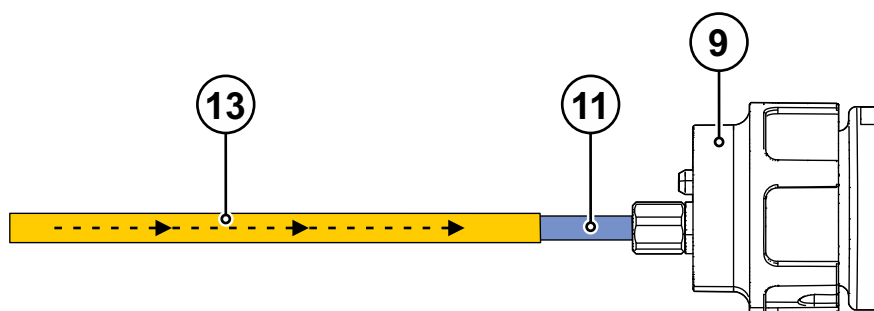





Figure 5-11

Item	Symbol	Description
1		Gas nozzle
2		Contact tip
3		Contact tip holder
4		Torch neck 45°
5		Crown nut
6		O-ring
7		Collet
8		Combined liner
9		Euro central connection
10		Connecting sleeve
11		New combined liner
12		Liner sharpener
13		Guiding tube for welding torch Euro torch connector

5.4.2 Guide spiral

-  **Insert the grinded end towards the contact tip holder to ensure tight fit with the contact tip.**
-  **Always make sure the the hose package is straight when replacing the wire guide.**

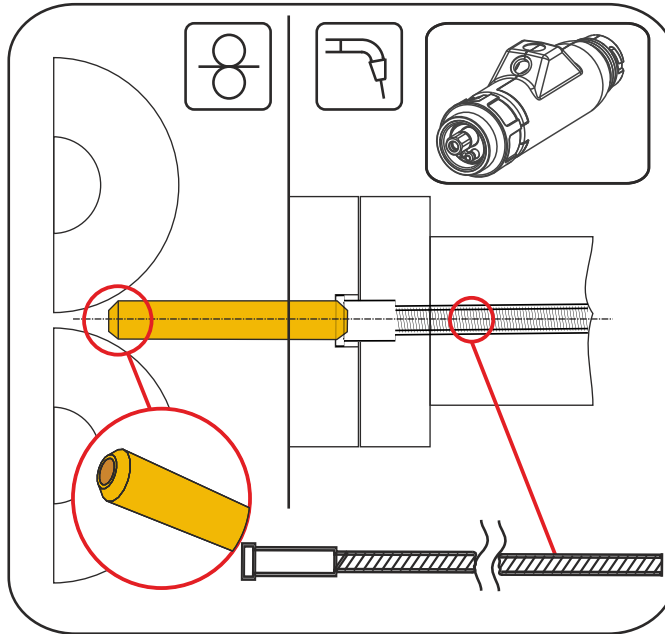

Figure 5-12

1.

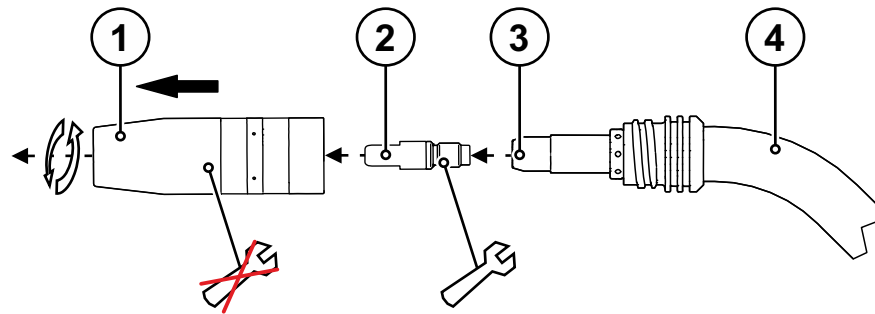

Figure 5-13

2.

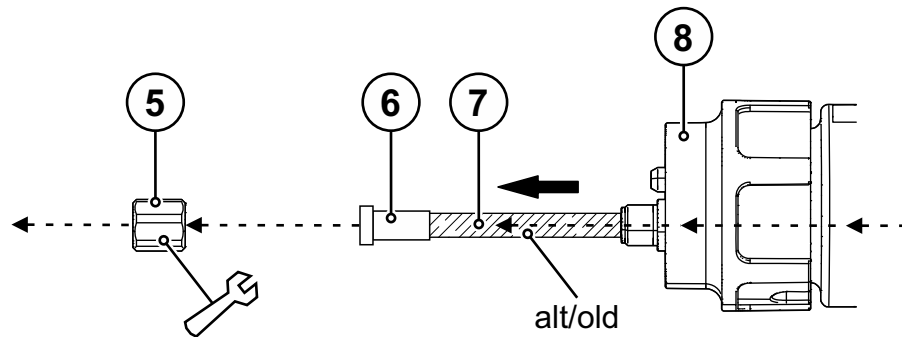

Figure 5-14

3.

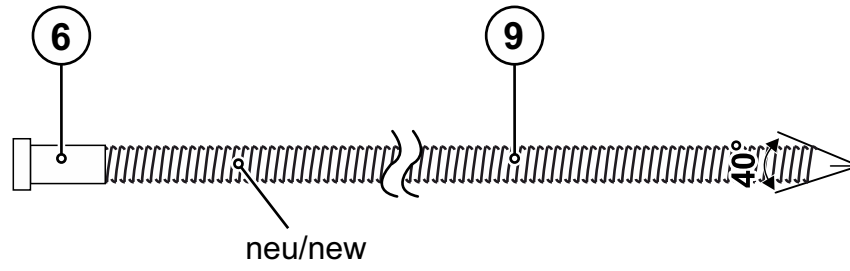

Figure 5-15

4.

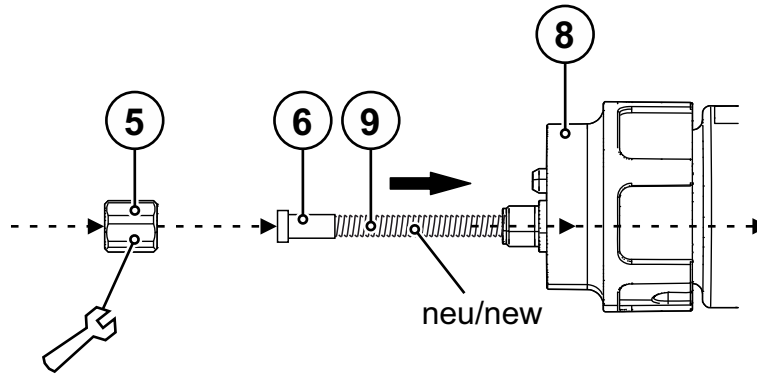

Figure 5-16

5.

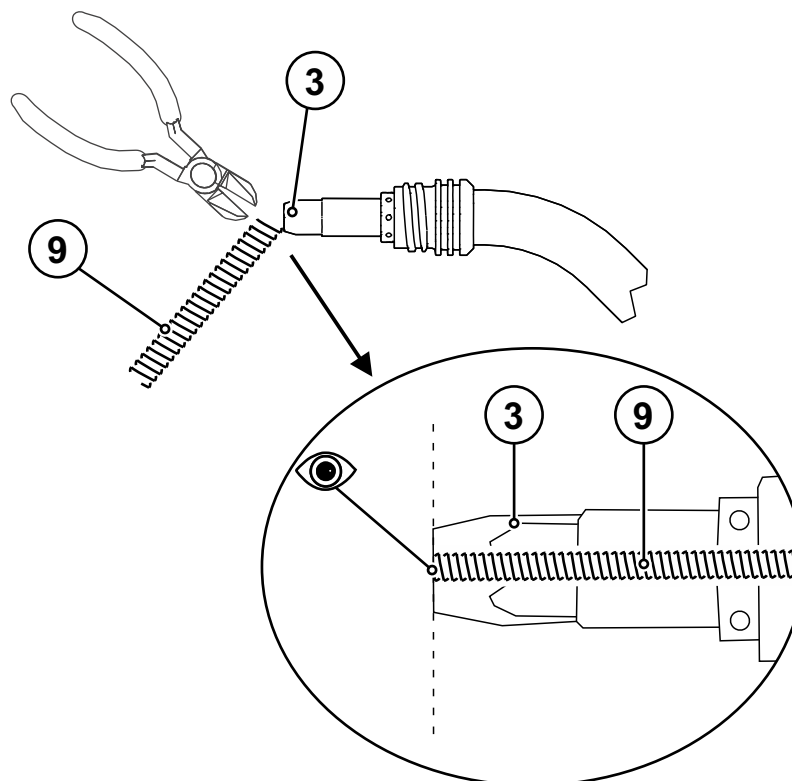

Figure 5-17

6.

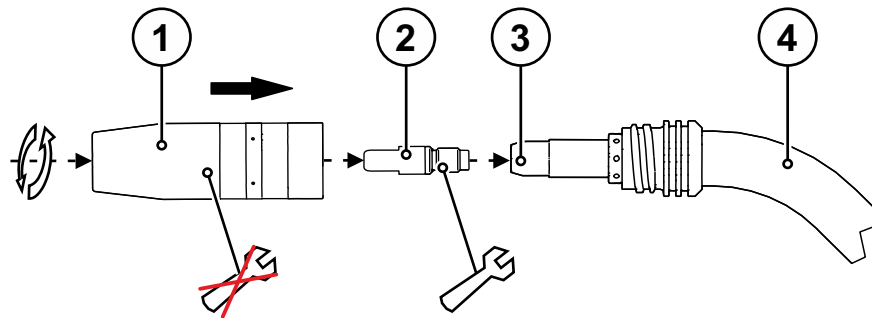

Figure 5-18

7.

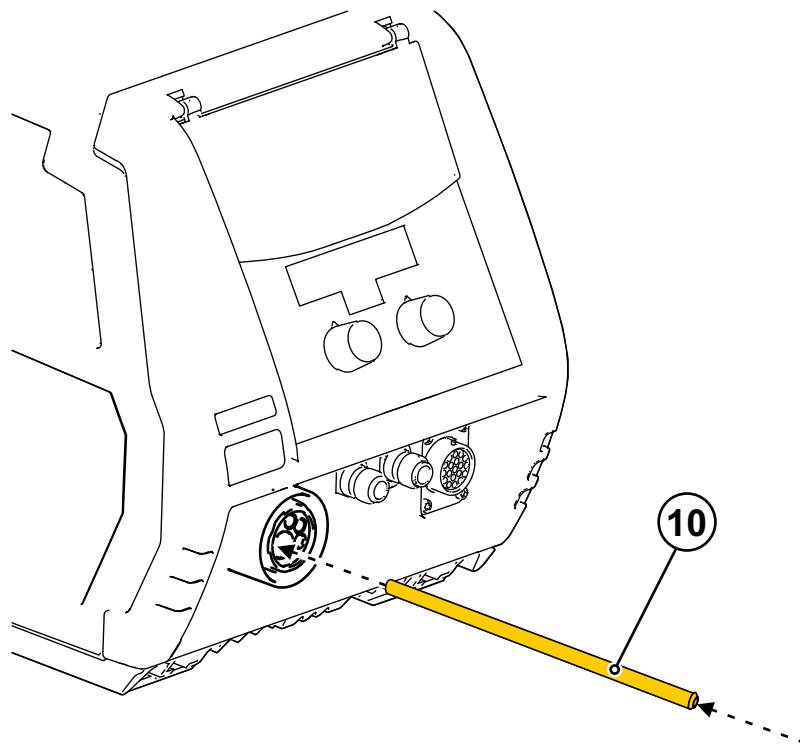



Figure 5-19

Item	Symbol	Description
1		Gas nozzle
2		Contact tip
3		Contact tip holder
4		Welding torch neck
5		Crown nut, welding torch central connection (euro)
6		Centring sleeve
7		old spiral guide
8		Euro central connection
9		new spiral guide
10		Capillary tube

6 Maintenance, care and disposal

CAUTION



Electrical current!

The following work must always be carried out with the power source switched off.



Disconnect the welding torch from the connected device, before maintenance.

6.1 Maintenance work, intervals

6.1.1 Daily maintenance tasks

- Purge the wire guide from the direction of the Euro torch connector with oil- and condensate-free compressed air or shielding gas.
- Purge the wire guide from the direction of the Euro torch connector with oil- and condensate-free compressed air or shielding gas.
- Check that all connections and wearing parts are hand-tight and tighten if necessary.
- Remove any spatter.

6.1.2 Monthly maintenance tasks

- Check and clean the welding torch. Deposits in the torch can cause short circuits and have a negative impact on the welding result, ultimately causing damage to the torch.
- Check torch, hose package and power connections for exterior damage and replace or have repaired by specialist staff as necessary!

6.2 Maintenance work



Electric current!

Repairs may only be carried out by authorised specialist staff!

- ***Do not remove the torch from the hose package!***
- ***Never clamp the torch body in a vice or similar, as this can cause the torch to be irreparably destroyed!***
- ***If damage occurs to the torch or to the hose package which cannot be corrected as part of the maintenance work, the entire torch must be returned to the manufacturer***

6.3 Disposing of equipment



Proper disposal!

The machine contains valuable raw materials, which should be recycled, and electronic components, which must be disposed of.

- **Do not dispose of in household waste!**
- **Observe the local regulations regarding disposal!**



6.3.1 Manufacturer's declaration to the end user

- According to European provisions (guideline 2012/19/EU of the European Parliament and the Council of July, 4th 2012), used electric and electronic equipment may no longer be placed in unsorted municipal waste. It must be collected separately. The symbol depicting a waste container on wheels indicates that the equipment must be collected separately.
This machine is to be placed for disposal or recycling in the waste separation systems provided for this purpose.
- According to German law (law governing the distribution, taking back and environmentally correct disposal of electric and electronic equipment (ElektroG) from 16.03.2005), used machines are to be placed in a collection system separate from unsorted municipal waste. The public waste management utilities (communities) have created collection points at which used equipment from private households can be disposed of free of charge.
- Information about giving back used equipment or about collections can be obtained from the respective municipal administration office.
- EWM participates in an approved waste disposal and recycling system and is registered in the Used Electrical Equipment Register (EAR) under number WEEE DE 57686922.
- In addition to this, returns are also possible throughout Europe via EWM sales partners.

6.4 Meeting the requirements of RoHS

We, EWM AG Mündersbach, hereby confirm that all products supplied by us which are affected by the RoHS Directive, meet the requirements of the RoHS (Directive 2011/65/EU).

7 Rectifying faults

All products are subject to rigorous production checks and final checks. If, despite this, something fails to work at any time, please check the product using the following flowchart. If none of the fault rectification procedures described leads to the correct functioning of the product, please inform your authorised dealer.

7.1 Checklist for rectifying faults

 **The correct machine equipment for the material and process gas in use is a fundamental requirement for perfect operation!**

Legend	Symbol	Description
	↗	Fault/Cause
	✘	Remedy

Welding torch overheated

- ↗ Loose welding current connections
 - ✘ Tighten power connections on the torch and/or on the workpiece
 - ✘ Tighten contact tip correctly
- ↗ Overload
 - ✘ Check and correct welding current setting
 - ✘ Use a more powerful welding torch

Functional error with the welding torch operating elements

- ↗ Connection problems
 - ✘ Make control lead connections and check that they are fitted correctly.
- ↗ Machine immediately switches to start mode or the 7-bar display remains inactive
 - ✘ Check polarity of the torch trigger lead at the Euro torch connector.

Wire feed problems

- ↗ Unsuited or worn welding torch equipment
 - ✘ Adjust contact tip to wire diameter and -material and replace if necessary
 - ✘ Adjust wire guide to material in use, blow through and replace if necessary
- ↗ Kinked hose packages
 - ✘ Extend and lay out the torch hose package
- ↗ Incompatible parameter settings
 - ✘ Check settings and correct if necessary

Unstable arc

- ↗ Unsuited or worn welding torch equipment
 - ✘ Adjust contact tip to wire diameter and -material and replace if necessary
 - ✘ Adjust wire guide to material in use, blow through and replace if necessary
- ↗ Incompatible parameter settings
 - ✘ Check settings and correct if necessary

Pore formation

- ✓ Inadequate or missing gas shielding
 - ✘ Check shielding gas setting and replace shielding gas cylinder if necessary
 - ✘ Shield welding site with protective screens (draughts affect the welding result)
- ✓ Unsuitable or worn welding torch equipment
 - ✘ Check size of gas nozzle and replace if necessary
- ✓ Condensation (hydrogen) in the gas tube
 - ✘ Purge hose package with gas or replace
- ✓ Splashes in the gas nozzle
- ✓ Gas distributor out of order or missing

7.2 Functional check PC1X – PC2X

The welding torch shown is an example only. Depending on the type used, torches may vary.

Mode for checking the display and push-buttons at the welding torch. Pressing the push-buttons will select the separate LEDs on the display one after the other. At the same time, individual bars will flash and skip once the push-button is pressed again.

Applies for all PC1X / PC2X welding torches and in combination with the drive 4X wire feeder only.

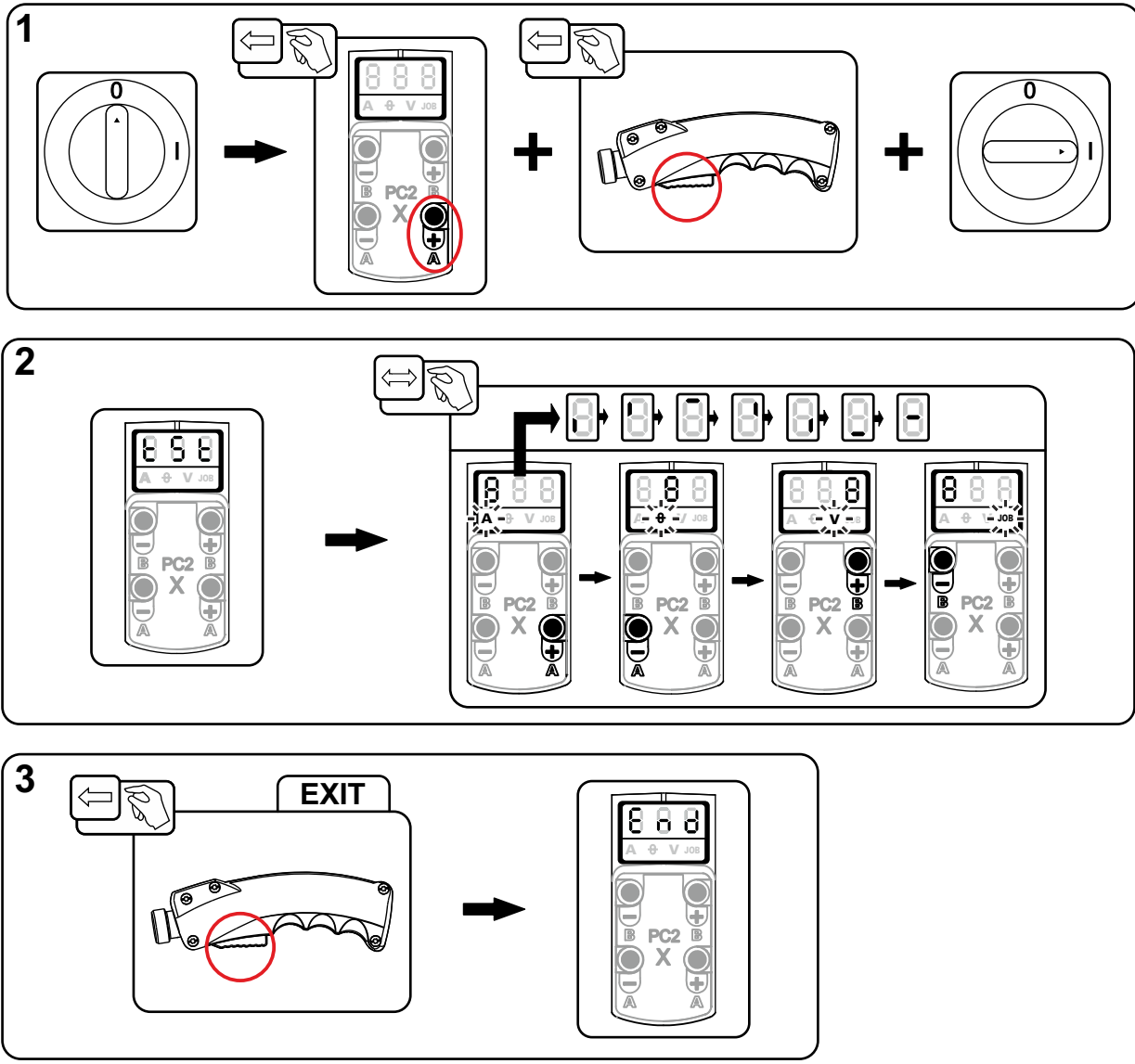

Figure 7-1

8 Technical data

8.1 MT 221G/X, MT 301G/X, MT 401G/X,

 *Performance specifications and guarantee only in connection with original spare and replacement parts!*

Type	MT221G MT221GX	MT301G MT301GX	MT401G MT401GX
Welding torch polarity	Usually positive		
Guide type	Manually operated		
Voltage type	DC		
Shielding gas	CO ₂ or mixed gas M21 according to BS EN 439		
Duty cycle	35%/60%	35%/60%	35%
Maximum welding current M21	250 A/220 A	330 A/300 A	400 A
Maximum welding current pulse M21	170 A/150 A	220 A/200 A	260 A
Maximum welding current CO ₂	300 A/250 A	380 A/330 A	450 A
Switching voltage microswitch	15 V		
Switching current microswitch	10 mA		
Wire types	Standard round wires		
Wire diameter	0.8–1.2 mm	0.8–1.6 mm	0.8–2.0 mm
Ambient temperature	-10 °C to +40 °C		
Manual voltage measurement	113 V (peak value)		
Protection classification of the machine connections (EN 60529)	IP3X		
Gas flow	10 to 20 l/min		
Hose package length	3 m/4 m/5 m		
Connection	Euro torch connector		
Constructed to standard	IEC 60974-7		

9 Replaceable parts

The manufacturer's warranty becomes void if non-genuine parts are used!

- Only use system components and options (power sources, welding torches, electrode holders, remote controls, spare parts and replacement parts, etc.) from our range of products!
- Only insert and lock accessory components into the relevant connection socket when the machine is switched off.

9.1 MT221G

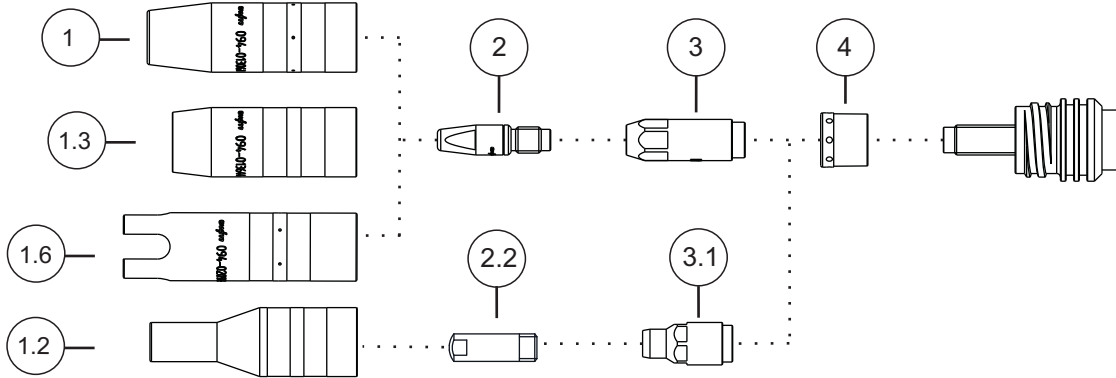

Figure 9-1

Item.	Order number	Type	Designation
1	094-013061-00001	GN TR 20 66mm D=13mm	Gas nozzle
1	094-013062-00001	GN TR 20 66mm D=11mm	Gas nozzle
1	094-013063-00001	GN TR 20 66mm D=16mm	Gas nozzle
1.2	094-020136-00000	GN TR 20x4 68mm D=10,5mm	Gas nozzle cylinder neck
1.3	094-013644-00000	GN FCW TR 20 58mm	Gas nozzle, Innershield
1.6	094-020944-00000	GN TR 20, 75 mm, D=18 mm	Spot welding nozzle
2	094-013071-00000	CT M6 CuCrZr, D=0,8 mm	Contact tip
2	094-013072-00000	CT M6 CuCrZr, D=1,0 mm, L=28 mm	Contact tip
2	094-013122-00000	CT M6 CuCrZr, D=0,9 mm	Contact tip
2	094-013535-00000	CT CUCRZR M7X30MM D=0.8MM	Contact tip
2	094-013536-00000	CT CUCRZR M7X30MM D=0.9MM	Contact tip
2	094-013537-00000	CT CUCRZR M7X30MM D=1.0MM	Contact tip
2	094-013538-00000	CT CUCRZR M7X30MM D=1.2MM	Contact tip
2	094-013550-00000	CTAL E-CU M7X30MM D=0.8MM	Contact tip, aluminium welding
2	094-013551-00000	CTAL E-CU M7X30MM D=0.9MM	Contact tip, aluminium welding
2	094-013552-00000	CTAL E-CU M7X30MM D=1.0MM	Contact tip, aluminium welding
2	094-013553-00000	CTAL E-CU M7X30MM D=1.2MM	Contact tip, aluminium welding
2	094-014317-00000	CT M6 CuCrZr D=1,2 mm	Contact tip
2	094-016101-00000	CT M6x28mm 0.8mm E-CU	Contact tip
2	094-016102-00000	CT M6x28mm 0.9mm E-CU	Contact tip
2	094-016103-00000	CT M6x28mm 1.0mm E-CU	Contact tip
2	094-016104-00000	CT M6x28mm 1.2mm E-CU	Contact tip
2	094-016105-00000	CTAL E-CU M6X28MM D=0.8MM	Contact tip, aluminium welding
2	094-016106-00000	CTAL E-CU M6X28MM D=0.9MM	Contact tip, aluminium welding
2	094-016107-00000	CTAL E-CU M6X28MM D=1.0MM	Contact tip, aluminium welding
2	094-016108-00000	CTAL E-CU M6X28MM D=1.2MM	Contact tip, aluminium welding
2.2	094-005403-00000	CT M6 x 25 mm, 0.6 mm, CuCrZr	Contact tip
2.2	094-020689-00000	CT M6 x 25 mm, 0.8 mm, CuCrZr	Contact tip
2.2	094-020690-00000	CT M6 x 25 mm, 1.0 mm, CuCrZr	Contact tip

Item.	Order number	Type	Designation
2.2	094-020691-00000	CT M6 x 25 mm, 0.6 mm, E-Cu	Contact tip
2.2	094-020692-00000	CT M6 x 25 mm, 0.8 mm, E-Cu	Contact tip
2.2	094-020693-00000	CT M6 x 25 mm, 0.9 mm, E-Cu	Contact tip
2.2	094-020694-00000	CT M6 x 25 mm, 1.0 mm, E-Cu	Contact tip
2.2	094-020695-00000	CT M6 x 25 mm, 0.6 mm, E-Cu (Alu)	Contact tip, aluminium welding
2.2	094-020696-00000	CT M6 x 25 mm, 0.8 mm, E-Cu (Alu)	Contact tip, aluminium welding
2.2	094-020697-00000	CT M6 x 25 mm, 0.9 mm, E-Cu (Alu)	Contact tip, aluminium welding
2.2	094-020698-00000	CT M6 x 25 mm, 1.0 mm, E-Cu (Alu)	Contact tip, aluminium welding
3	094-013069-00002	CTH CUCRZR M6 L=30.5MM	Contact tip holder
3	094-013070-00002	CTH CUCRZR M6 L=33.5MM	Contact tip holder
3	094-013542-00002	CTH CUCRZR M7 L=34.5MM	Contact tip holder
3	094-013541-00002	CTH CUCRZR M7 L=31.5MM	Contact tip holder
3.1	094-020562-00000	CTH M6 CuCrZr 30.5mm	Contact tip holder
4	094-013094-00002	GD MT221G / MT301W	Gas diffuser
-	094-016038-00001	TT SW5-SW12MM	Torch key

9.2 MT301G

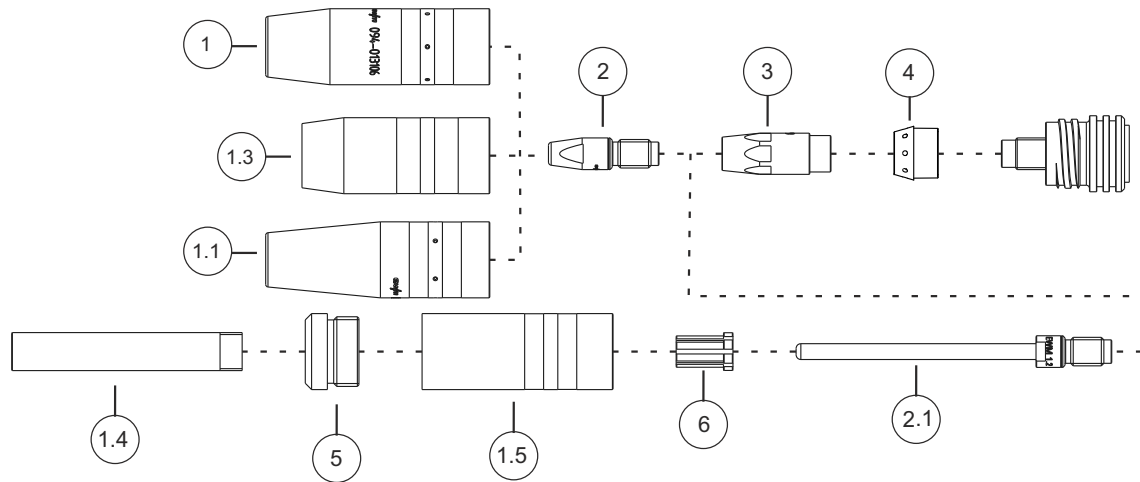

Figure 9-2

Item	Order number	Type	Description
1	094-013105-00001	GN TR 22 71mm D=13mm	Gas nozzle
1	094-013106-00001	GN TR 22 71mm D=15mm	Gas nozzle
1	094-013107-00001	GN TR 22 71mm D=18mm	Gas nozzle
1	094-019821-00001	GN TR 22 65mm D=15mm	Gas nozzle, short
1	094-019822-00001	GN TR 22 65mm D=18mm	Gas nozzle, short
1.1	094-019853-00001	GN NG TR22X4 71mm D=13mm	Highly conical gas nozzle, narrow gap welding
1.3	094-019554-00000	GN FCW TR 22x4 59.5MM	Gas nozzle, Innershield
1.4	094-019626-00000	GN NG M12 73mm	Gas nozzle, narrow gap welding
1.5	094-019623-00000	GNC TR22x4	Gas nozzle body
1.6	094-020945-00000	GN TR 22, 80 mm, D=20 mm	Spot welding nozzle
2	094-007238-00000	CT E-CU M8X30MM D=1.2MM	Contact tip
2	094-013113-00000	CT M8 CuCrZr 30mm, 1.2mm	Contact tip
2	094-013129-00000	CT CUCRZR M8X30MM D=0.9MM	Contact tip
2	094-013528-00000	CT CUCRZR M9X35MM D=0.8MM	Contact tip
2	094-013529-00000	CT CUCRZR M9X35MM D=0.9MM	Contact tip
2	094-013530-00000	CT M9 CuCrZr 1.0mm	Contact tip
2	094-013531-00000	CT CUCRZR M9X35MM D=1.2MM	Contact tip
2	094-013532-00000	CT CUCRZR M9X35MM D=1.4MM	Contact tip
2	094-013533-00000	CT CUCRZR M9X35MM D=1.6MM	Contact tip
2	094-013543-00000	CTAL E-CU M9X35MM D=0.8MM	Contact tip, aluminium welding
2	094-013544-00000	CTAL E-CU M9X35MM D=0.9MM	Contact tip, aluminium welding
2	094-013545-00000	CTAL E-CU M9X35MM D=1.0MM	Contact tip, aluminium welding
2	094-013546-00000	CTAL E-CU M9X35MM D=1.2MM	Contact tip, aluminium welding
2	094-013547-00000	CTAL E-CU M9X35MM D=1.4MM	Contact tip, aluminium welding
2	094-013548-00000	CTAL E-CU M9X35MM D=1.6MM	Contact tip, aluminium welding
2	094-014024-00000	CT CUCRZR M8X30MM D=0.8MM	Contact tip
2	094-014191-00000	CT CUCRZR M8X30MM D=1.4MM	Contact tip
2	094-014192-00000	CT CUCRZR M8X30MM D=1.6MM	Contact tip
2	094-014222-00000	CT CUCRZR M8X30MM D=1.0MM	Contact tip
2	094-016109-00000	CT E-CU M8X30MM D=0.8MM	Contact tip
2	094-016110-00000	CT E-CU M8X30MM D=0.9MM	Contact tip
2	094-016111-00000	CT E-CU M8X30MM D=1.0MM	Contact tip

Item	Order number	Type	Description
2	094-016112-00000	CT E-CU M8X30MM D=1.4MM	Contact tip
2	094-016113-00000	CT E-CU M8X30MM D=1.6MM	Contact tip
2	094-016115-00000	CTAL E-CU M8X30MM D=0.8MM	Contact tip, aluminium welding
2	094-016116-00000	CTAL E-CU M8X30MM D=0.9MM	Contact tip, aluminium welding
2	094-016117-00000	CTAL E-CU M8X30MM D=1.0MM	Contact tip, aluminium welding
2	094-016118-00000	CTAL E-CU M8X30MM D=1.2MM	Contact tip, aluminium welding
2	094-016119-00000	CTAL E-CU M8X30MM D=1.4MM	Contact tip, aluminium welding
2	094-016120-00000	CTAL E-CU M8X30MM D=1.6MM	Contact tip, aluminium welding
2.1	094-019616-00000	CT M9 x 100 mm; Ø 1,0 mm CuCrZr	Contact tip, narrow gap welding
2.1	094-019617-00000	CT M9 x 100 mm; Ø 1,2 mm CuCrZr	Contact tip, narrow gap welding
2.1	094-019618-00000	CT M9 x 100 mm; Ø 1,6 mm CuCrZr	Contact tip, narrow gap welding
2.1	094-020019-00000	CT M9 x 100 mm; Ø 1,4 mm CuCrZr	Contact tip, narrow gap welding
2.1	094-021189-00000	CT M9 x 100 mm; Ø 0,8 mm CuCrZr	Contact tip, narrow gap welding
3	094-013109-00002	CTH CUCRZR M8 L=34.1MM	Contact tip holder
3	094-013110-00002	CTH CUCRZR M8 L=37.1MM	Contact tip holder
3	094-013539-00002	CTH M9 CuCrZr 34.5mm	Contact tip holder
3	094-013540-00002	CTH M9 CuCrZr 37.5mm	Contact tip holder
4	094-013096-00003	GD MT301/451	Gas diffuser
5	094-019625-00000	IT ES M22X1,5 M12X1	Insulation part
6	094-019627-00000	ZH GDE ID=5MM AD=10MM L=15MM	Centring sleeve
-	094-016038-00001	TT SW5-SW12MM	Torch key

9.3 MT401G

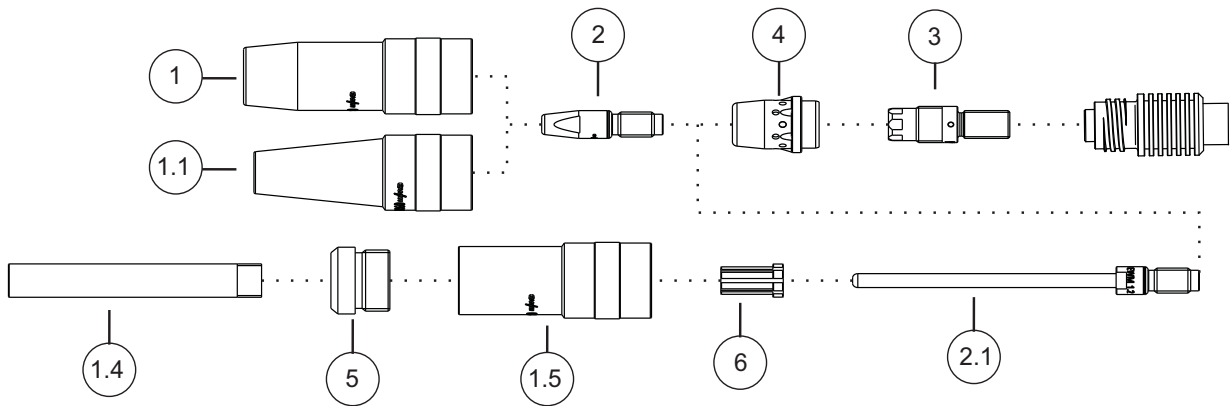

Figure 9-3

Item	Order number	Type	Description
1	094-014177-00001	GN TR 23 63mm D=15mm	Gas nozzle
1	094-014178-00001	GN TR 23 66mm D=15mm	Gas nozzle
1	094-014179-00001	GN TR 23 63mm D=17mm	Gas nozzle
1	094-014180-00001	GN TR 23 66mm D=17mm	Gas nozzle
1	094-014181-00001	GN TR 23 63mm D=19mm	Gas nozzle
1	094-014182-00001	GN TR 23 66mm D=19mm	Gas nozzle
1.1	094-019702-00000	GN NG TR23X4 63mm D=13mm	Highly conical gas nozzle, narrow gap welding
1.4	094-019626-00000	GN NG M12 73mm	Gas nozzle, narrow gap welding
1.5	094-019624-00000	GNC TR23x4	Gas nozzle body
2	094-007238-00000	CT E-CU M8X30MM D=1.2MM	Contact tip
2	094-013113-00000	CT M8 CuCrZr 30mm, 1.2mm	Contact tip
2	094-013129-00000	CT CUCRZR M8X30MM D=0.9MM	Contact tip
2	094-013528-00000	CT CUCRZR M9X35MM D=0.8MM	Contact tip
2	094-013529-00000	CT CUCRZR M9X35MM D=0.9MM	Contact tip
2	094-013530-00000	CT M9 CuCrZr 1.0mm	Contact tip
2	094-013531-00000	CT CUCRZR M9X35MM D=1.2MM	Contact tip
2	094-013532-00000	CT CUCRZR M9X35MM D=1.4MM	Contact tip
2	094-013533-00000	CT CUCRZR M9X35MM D=1.6MM	Contact tip
2	094-013534-00000	CT CUCRZR M9X35MM D=2.0MM	Contact tip
2	094-013543-00000	CTAL E-CU M9X35MM D=0.8MM	Contact tip, aluminium welding
2	094-013544-00000	CTAL E-CU M9X35MM D=0.9MM	Contact tip, aluminium welding
2	094-013545-00000	CTAL E-CU M9X35MM D=1.0MM	Contact tip, aluminium welding
2	094-013546-00000	CTAL E-CU M9X35MM D=1.2MM	Contact tip, aluminium welding
2	094-013547-00000	CTAL E-CU M9X35MM D=1.4MM	Contact tip, aluminium welding
2	094-013548-00000	CTAL E-CU M9X35MM D=1.6MM	Contact tip, aluminium welding
2	094-013549-00000	CTAL E-CU M9X35MM D=2.0MM	Contact tip, aluminium welding
2	094-014024-00000	CT CUCRZR M8X30MM D=0.8MM	Contact tip
2	094-014191-00000	CT CUCRZR M8X30MM D=1.4MM	Contact tip
2	094-014192-00000	CT CUCRZR M8X30MM D=1.6MM	Contact tip
2	094-014193-00000	CT CUCRZR M8X30MM D=2.0MM	Contact tip
2	094-014222-00000	CT CUCRZR M8X30MM D=1.0MM	Contact tip
2	094-016109-00000	CT E-CU M8X30MM D=0.8MM	Contact tip
2	094-016110-00000	CT E-CU M8X30MM D=0.9MM	Contact tip
2	094-016111-00000	CT E-CU M8X30MM D=1.0MM	Contact tip

Item	Order number	Type	Description
2	094-016112-00000	CT E-CU M8X30MM D=1.4MM	Contact tip
2	094-016113-00000	CT E-CU M8X30MM D=1.6MM	Contact tip
2	094-016114-00000	CT E-CU M8X30MM D=2.0MM	Contact tip
2	094-016115-00000	CTAL E-CU M8X30MM D=0.8MM	Contact tip, aluminium welding
2	094-016116-00000	CTAL E-CU M8X30MM D=0.9MM	Contact tip, aluminium welding
2	094-016117-00000	CTAL E-CU M8X30MM D=1.0MM	Contact tip, aluminium welding
2	094-016118-00000	CTAL E-CU M8X30MM D=1.2MM	Contact tip, aluminium welding
2	094-016119-00000	CTAL E-CU M8X30MM D=1.4MM	Contact tip, aluminium welding
2	094-016120-00000	CTAL E-CU M8X30MM D=1.6MM	Contact tip, aluminium welding
2	094-016920-00000	CTAL E-CU M8X30MM D=2.0MM	Contact tip, aluminium welding
2.1	094-019616-00000	CT M9 x 100 mm; Ø 1,0 mm CuCrZr	Contact tip, narrow gap welding
2.1	094-019617-00000	CT M9 x 100 mm; Ø 1,2 mm CuCrZr	Contact tip, narrow gap welding
2.1	094-019618-00000	CT M9 x 100 mm; Ø 1,6 mm CuCrZr	Contact tip, narrow gap welding
2.1	094-020019-00000	CT M9 x 100 mm; Ø 1,4 mm CuCrZr	Contact tip, narrow gap welding
2.1	094-021189-00000	CT M9 x 100 mm; Ø 0,8 mm CuCrZr	Contact tip, narrow gap welding
3	094-013856-00003	CTH CUCRZR M9 L=35MM	Contact tip holder
3	094-015489-00003	CTH M8 x 35 mm, CuCrZr	Contact tip holder
3	094-016018-00003	CTH M8 x 37,5 mm, CuCrZr	Contact tip holder
3	094-016425-00003	CTH CUCRZR M9 L=38MM	Contact tip holder
4	094-013111-00001	GD D=20,2 mm; 25 mm	Gas diffuser
5	094-019625-00000	IT ES M22X1,5 M12X1	Insulation part
6	094-019627-00000	ZH GDE ID=5MM AD=10MM L=15MM	Centring sleeve
-	094-016038-00001	TT SW5-SW12MM	Torch key

9.4 MT221G F / MT301G F

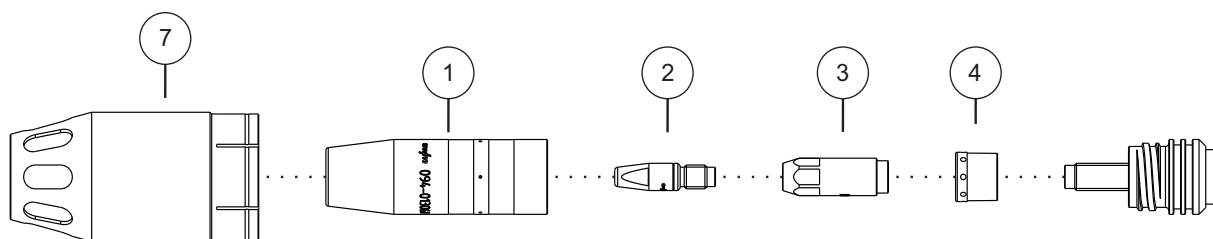

Figure 9-4

Item.	Order number	Type	Designation
1	094-013061-00001	GN TR 20 66mm D=13mm	Gas nozzle
1	094-013062-00001	GN TR 20 66mm D=11mm	Gas nozzle
1	094-013063-00001	GN TR 20 66mm D=16mm	Gas nozzle
2	094-013071-00000	CT M6 CuCrZr, D=0,8 mm	Contact tip
2	094-013072-00000	CT M6 CuCrZr, D=1,0 mm, L=28 mm	Contact tip
2	094-013122-00000	CT M6 CuCrZr, D=0,9 mm	Contact tip
2	094-013535-00000	CT CUCRZR M7X30MM D=0.8MM	Contact tip
2	094-013536-00000	CT CUCRZR M7X30MM D=0.9MM	Contact tip
2	094-013537-00000	CT CUCRZR M7X30MM D=1.0MM	Contact tip
2	094-013538-00000	CT CUCRZR M7X30MM D=1.2MM	Contact tip
2	094-013550-00000	CTAL E-CU M7X30MM D=0.8MM	Contact tip, aluminium welding
2	094-013551-00000	CTAL E-CU M7X30MM D=0.9MM	Contact tip, aluminium welding
2	094-013552-00000	CTAL E-CU M7X30MM D=1.0MM	Contact tip, aluminium welding
2	094-013553-00000	CTAL E-CU M7X30MM D=1.2MM	Contact tip, aluminium welding
2	094-014317-00000	CT M6 CuCrZr D=1,2 mm	Contact tip
2	094-016101-00000	CT M6x28mm 0.8mm E-CU	Contact tip
2	094-016102-00000	CT M6x28mm 0.9mm E-CU	Contact tip
2	094-016103-00000	CT M6x28mm 1.0mm E-CU	Contact tip
2	094-016104-00000	CT M6x28mm 1.2mm E-CU	Contact tip
2	094-016105-00000	CTAL E-CU M6X28MM D=0.8MM	Contact tip, aluminium welding
2	094-016106-00000	CTAL E-CU M6X28MM D=0.9MM	Contact tip, aluminium welding
2	094-016107-00000	CTAL E-CU M6X28MM D=1.0MM	Contact tip, aluminium welding
2	094-016108-00000	CTAL E-CU M6X28MM D=1.2MM	Contact tip, aluminium welding
3	094-013069-00002	CTH CUCRZR M6 L=30.5MM	Contact tip holder
3	094-013070-00002	CTH CUCRZR M6 L=33.5MM	Contact tip holder
3	094-013541-00002	CTH CUCRZR M7 L=31.5MM	Contact tip holder
4	094-013094-00002	GD MT221G / MT301W	Gas diffuser
7	094-014998-00000	RAD MT221GF/MT301WF	Extraction nozzle
-	094-016038-00001	TT SW5-SW12MM	Torch key

10 Circuit diagrams



The circuit diagrams are only intended for authorised service personnel!

10.1 MT U/D

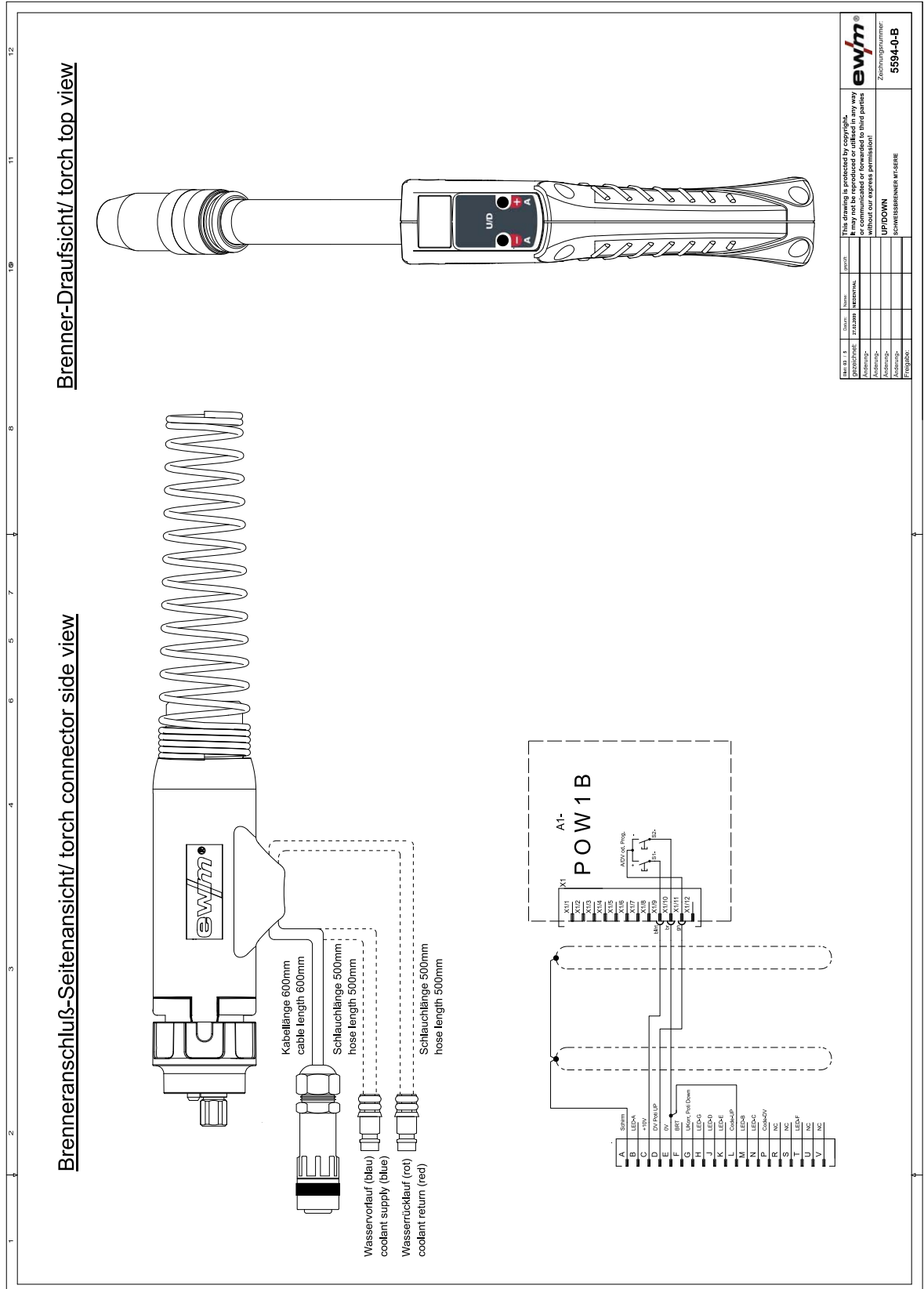

Figure 10-1

10.2 MT U/DX

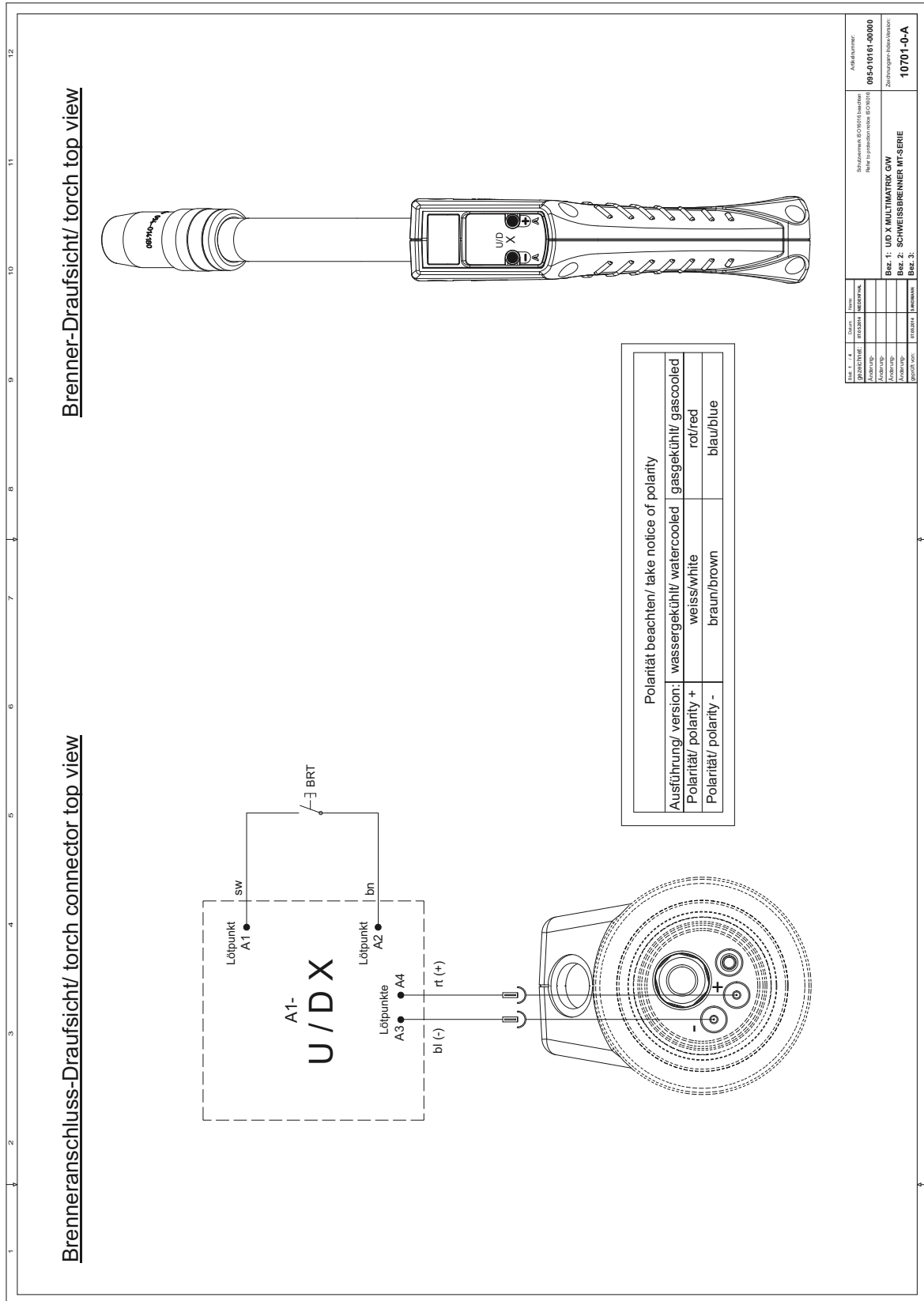

Figure 10-2

10.3 MT 2U/D

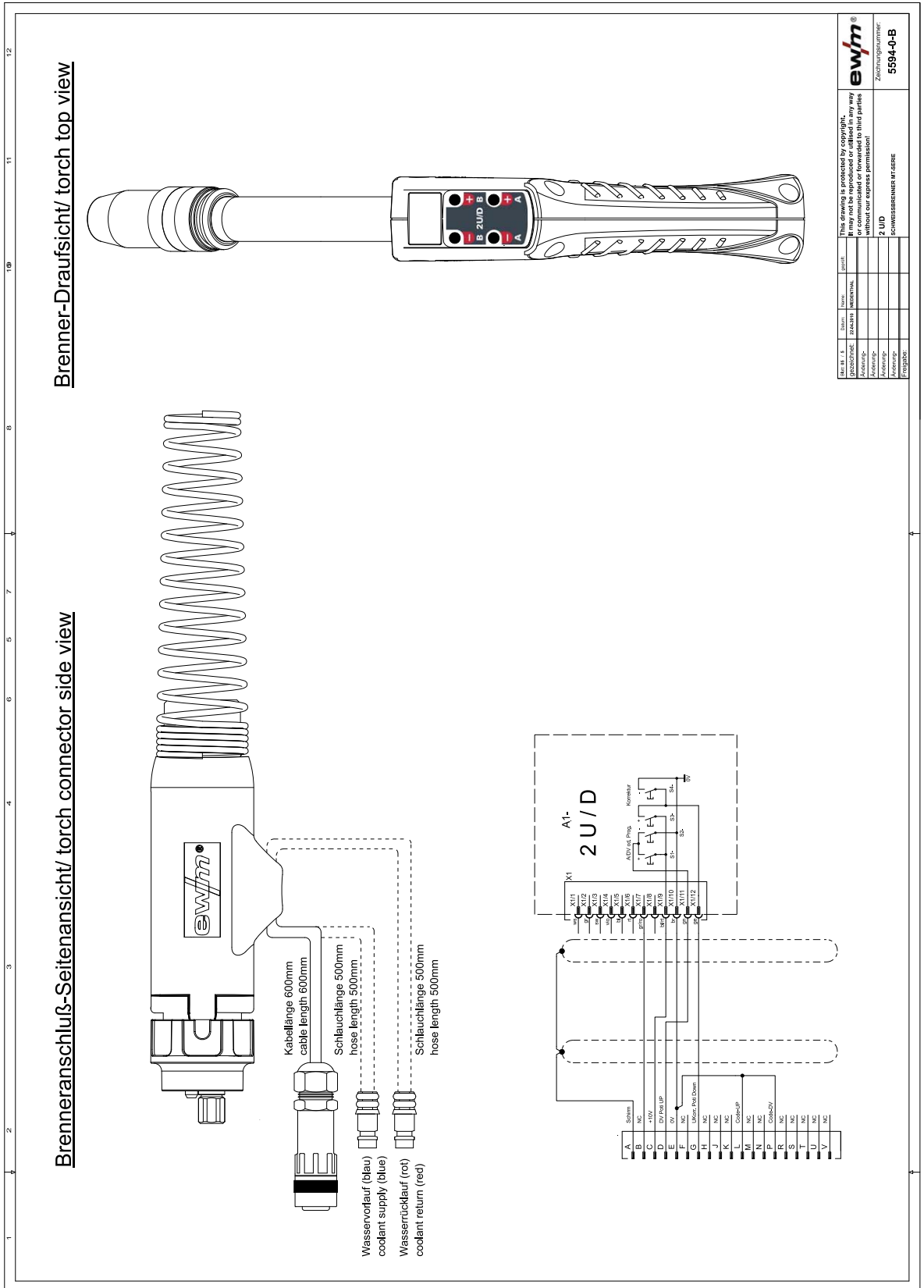

Figure 10-3

10.5 MT PC1

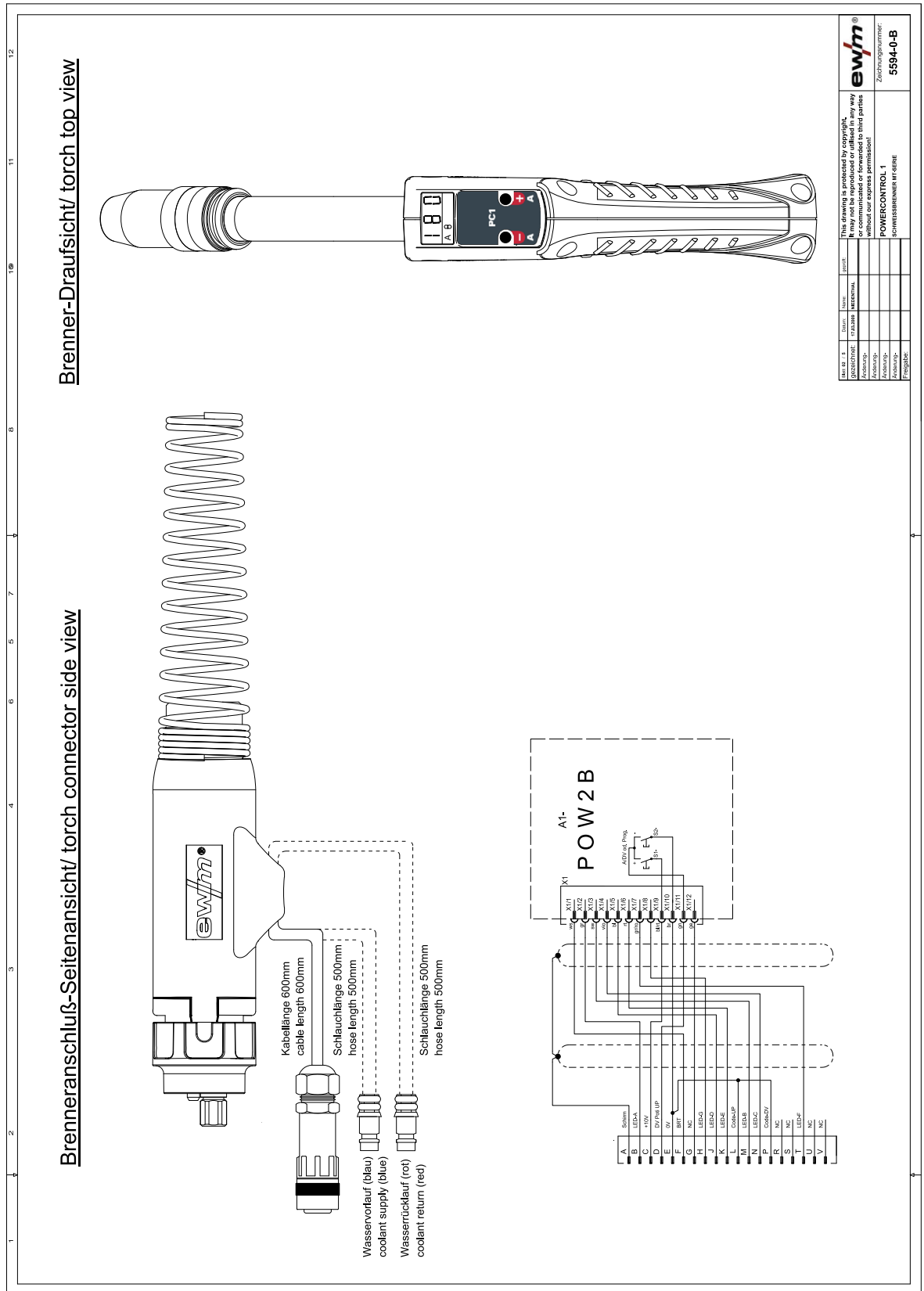

Figure 10-5

10.6 MT PC1X

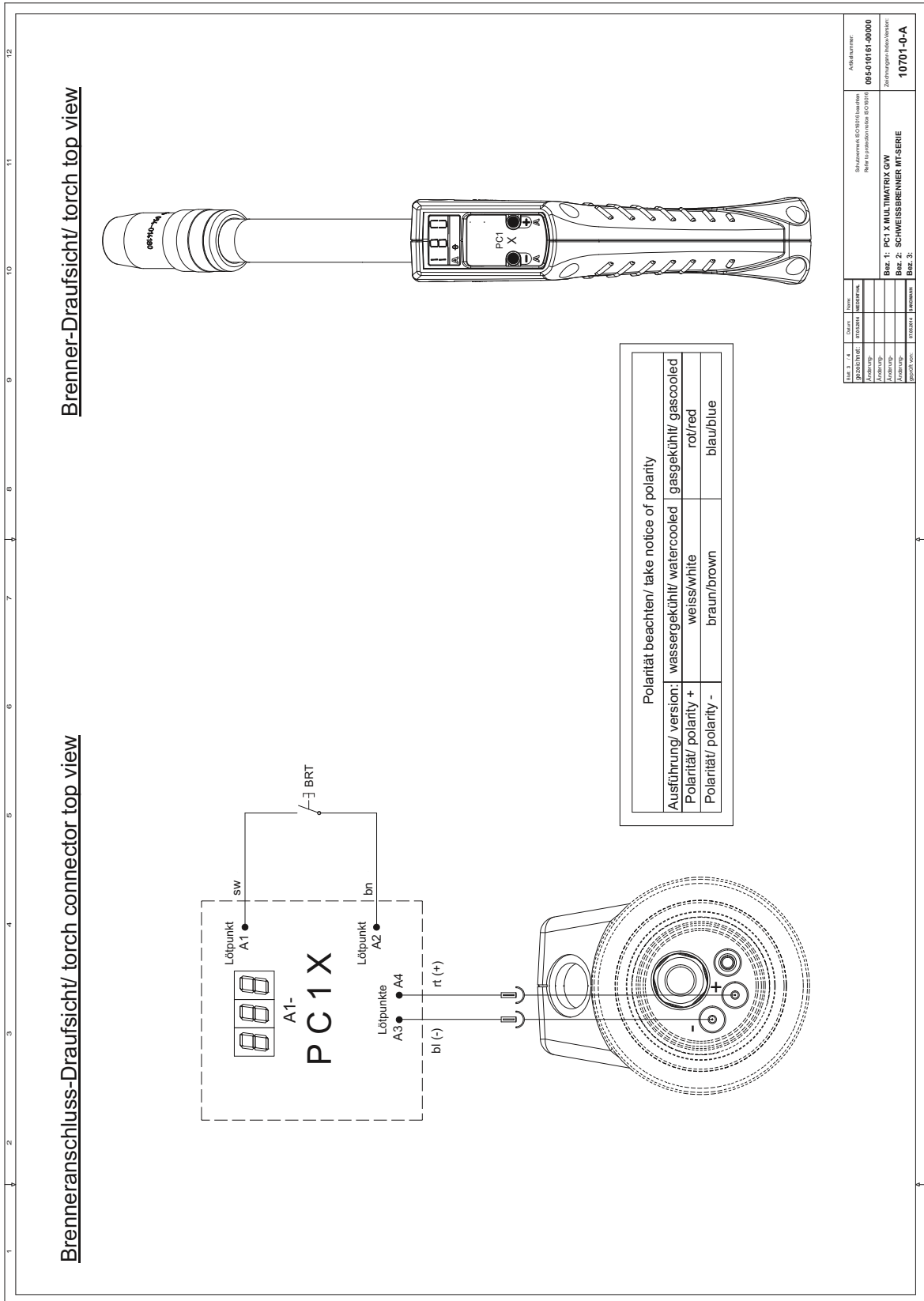

Figure 10-6

10.7 MT PC2

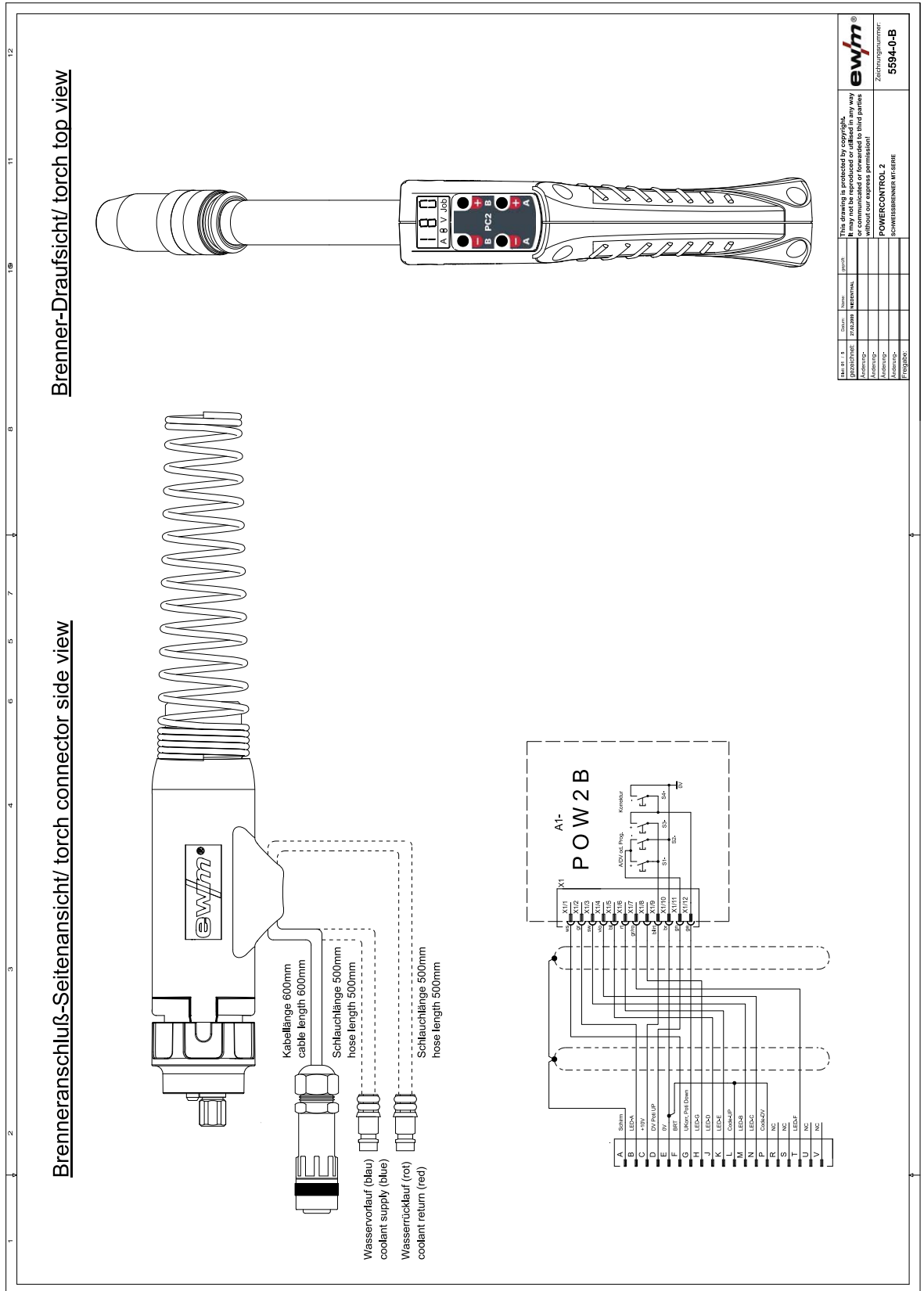

Figure 10-7

11 Appendix A

11.1 Overview of EWM branches

Headquarters

EWM AG
Dr. Günter-Henle-Straße 8
56271 Mündersbach · Germany
Tel: +49 2680 181-0 · Fax: -244
www.ewm-group.com · info@ewm-group.com

Technology centre

EWM AG
Forststraße 7-13
56271 Mündersbach · Germany
Tel: +49 2680 181-0 · Fax: -144
www.ewm-group.com · info@ewm-group.com

Production, Sales and Service

EWM AG
Dr. Günter-Henle-Straße 8
56271 Mündersbach · Germany
Tel: +49 2680 181-0 · Fax: -244
www.ewm-group.com · info@ewm-group.com

EWM HIGHTEC WELDING s.r.o.
9. května 718 / 31
407 53 Jiřikov · Czech Republic
Tel.: +420 412 358-551 · Fax: -504
www.ewm-jirikov.cz · info@ewm-jirikov.cz

EWM HIGH TECHNOLOGY (Kunshan) Ltd.
10 Yuanshan Road, Kunshan · New & Hi-tech Industry Development Zone
Kunshan City · Jiangsu · Post code 215300 · People's Republic of China
Tel: +86 512 57867-188 · Fax: -182
www.ewm.cn · info@ewm.cn · info@ewm-group.cn

Sales and Service Germany

EWM AG
Sales and Technology Centre
Grünauer Fenn 4
14712 Rathenow · Tel: +49 3385 49402-0 · Fax: -20
www.ewm-rathenow.de · info@ewm-rathenow.de

EWM HIGHTEC WELDING GmbH
Centre Technology and mechanisation
Daimlerstr. 4-6
69469 Weinheim · Tel: +49 6201 84557-0 · Fax: -20
www.ewm-weinheim.de · info@ewm-weinheim.de

EWM AG
Rudolf-Winkel-Straße 7-9
37079 Göttingen · Tel: +49 551-3070713-0 · Fax: -20
www.ewm-goettingen.de · info@ewm-goettingen.de

EWM Schweißtechnik Handels GmbH
Karlsdorfer Straße 43
88069 Tettngang · Tel: +49 7542 97998-0 · Fax: -29
www.ewm-tettngang.de · info@ewm-tettngang.de

EWM AG
Dieselstraße 9b
50259 Pulheim · Tel: +49 2238-46466-0 · Fax: -14
www.ewm-pulheim.de · info@ewm-pulheim.de

EWM Schweißtechnik Handels GmbH
Heinkelstraße 8
89231 Neu-Ulm · Tel: +49 731 7047939-0 · Fax: -15
www.ewm-neu-ulm.de · info@ewm-neu-ulm.de

EWM AG
August-Horch-Straße 13a
56070 Koblenz · Tel: +49 261 963754-0 · Fax: -10
www.ewm-koblenz.de · info@ewm-koblenz.de

EWM AG
Eiserfelder Straße 300
57080 Siegen · Tel: +49 271 3878103-0 · Fax: -9
www.ewm-siegen.de · info@ewm-siegen.de

Sales and Service International

EWM HIGH TECHNOLOGY (Kunshan) Ltd.
10 Yuanshan Road, Kunshan · New & Hi-tech Industry Development Zone
Kunshan City · Jiangsu · Post code 215300 · People's Republic of China
Tel: +86 512 57867-188 · Fax: -182
www.ewm.cn · info@ewm.cn · info@ewm-group.cn

EWM HIGHTEC WELDING UK Ltd.
Unit 2B Coopies Way · Coopies Lane Industrial Estate
Morpeth · Northumberland · NE61 6JN · Great Britain
Tel: +44 1670 505875 · Fax: -514305
www.ewm-morpeth.co.uk · info@ewm-morpeth.co.uk

EWM HIGHTEC WELDING GmbH
Wiesenstraße 27b
4812 Pinsdorf · Austria · Tel: +43 7612 778 02-0 · Fax: -20
www.ewm-austria.at · info@ewm-austria.at

EWM HIGHTEC WELDING Sales s.r.o. / Prodejní a poradenské centrum
Tyršova 2106
256 01 Benešov u Prahy · Czech Republic
Tel: +420 317 729-517 · Fax: -712
www.ewm-benesov.cz · info@ewm-benesov.cz

Liaison office Turkey

EWM AG Türkiye İrtibat Bürosu
İkitelli OSB Mah. · Marmara Sanayi Sitesi P Blok Apt. No: 44
Küçükçekmece / İstanbul Türkiye
Tel.: +90 212 494 32 19
www.ewm-istanbul.com.tr · info@ewm-istanbul.com.tr

 Plants

 Branches

 Liaison office

● More than 400 EWM sales partners worldwide