



EN

Control

Basic (M3.7X-L)

099-0M37XL-EW501

Observe additional system documents!

16.07.2018

**Register now
and benefit!
Jetzt Registrieren
und Profitieren!**

www.ewm-group.com



General instructions

WARNING



Read the operating instructions!

The operating instructions provide an introduction to the safe use of the products.

- Read and observe the operating instructions for all system components, especially the safety instructions and warning notices!
- Observe the accident prevention regulations and any regional regulations!
- The operating instructions must be kept at the location where the machine is operated.
- Safety and warning labels on the machine indicate any possible risks. Keep these labels clean and legible at all times.
- The machine has been constructed to state-of-the-art standards in line with any applicable regulations and industrial standards. Only trained personnel may operate, service and repair the machine.
- Technical changes due to further development in machine technology may lead to a differing welding behaviour.

In the event of queries on installation, commissioning, operation or special conditions at the installation site, or on usage, please contact your sales partner or our customer service department on +49 2680 181-0.

A list of authorised sales partners can be found at www.ewm-group.com/en/specialist-dealers.

Liability relating to the operation of this equipment is restricted solely to the function of the equipment. No other form of liability, regardless of type, shall be accepted. This exclusion of liability shall be deemed accepted by the user on commissioning the equipment.

The manufacturer is unable to monitor whether or not these instructions or the conditions and methods are observed during installation, operation, usage and maintenance of the equipment.

An incorrectly performed installation can result in material damage and injure persons as a result. For this reason, we do not accept any responsibility or liability for losses, damages or costs arising from incorrect installation, improper operation or incorrect usage and maintenance or any actions connected to this in any way.

© EWM AG

Dr. Günter-Henle-Strasse 8
56271 Mündersbach Germany
Tel.: +49 2680 181-0, Fax: -244
Email: info@ewm-group.com
www.ewm-group.com

The copyright to this document remains the property of the manufacturer.

Copying, including extracts, only permitted with written approval.

The content of this document has been prepared and reviewed with all reasonable care. The information provided is subject to change; errors excepted.

1 Contents

1	Contents	3
2	For your safety	5
2.1	Notes on the use of these operating instructions	5
2.2	Explanation of icons.....	5
2.3	Part of the complete documentation	6
3	Intended use	7
3.1	Use and operation solely with the following machines	7
3.2	Documents which also apply	7
3.3	Software version	7
4	Machine control – Operating elements	8
4.1	Overview of control sections	8
4.1.1	Control section A	9
4.1.2	Control section B	10
4.2	Welding data display	11
4.3	Operating the machine control.....	12
4.3.1	Main screen	12
4.3.2	Welding power setting	12
4.3.3	Changing basic settings (machine configuration menu)	12
4.3.4	Lock function	12
5	Functional characteristics	13
5.1	Shielding gas volume settings	13
5.1.1	Gas test	13
5.1.2	Purge hose package.....	13
5.2	Wire thread	14
5.3	Wire return	14
5.4	MIG/MAG welding.....	15
5.4.1	Welding task selection.....	15
5.4.2	Welding procedure	15
5.4.2.1	Operating mode	15
5.4.2.2	Welding power (operating point)	16
5.4.2.3	Arc dynamics (choke effect).....	17
5.4.3	Expert menu (MIG/MAG).....	17
5.4.3.1	Burn-back.....	18
5.4.4	Operating modes (functional sequences)	18
5.4.4.1	Explanation of signs and functions	18
5.4.4.2	Automatic cut-out	18
5.4.5	Standard MIG/MAG torch.....	20
5.4.5.1	Switching between Push/Pull and intermediate drive	20
5.5	MMA welding	21
5.5.1	Welding task selection.....	21
5.5.2	Welding current setting.....	21
5.5.3	Arcforce	21
5.5.4	Hotstart	22
5.5.5	Antistick	22
5.6	Air arc gouging.....	22
5.6.1	Welding task selection.....	22
5.6.2	Welding current setting.....	22
5.7	Special parameters (advanced settings)	22
5.7.1	Selecting, changing and saving parameters	23
5.7.1.1	Ramp time for wire inching (P1).....	23
5.7.1.2	Latched/special-latched tap start (P9)	24
5.7.1.3	Hold function (P15)	24
5.7.1.4	Correction or nominal voltage display (P24)	24
5.7.1.5	Units system (P29).....	24
5.7.2	Reset to factory settings.....	24
5.8	Machine configuration menu.....	25
5.8.1	Selecting, changing and saving parameters	25
5.8.2	Aligning the cable resistance.....	26

5.8.3	Power-saving mode (Standby)	27
6	Rectifying faults	28
6.1	Display machine control software version.....	28
6.2	Error messages (power source).....	28
7	Appendix A	30
7.1	Setting instructions.....	30
8	Appendix B	31
8.1	Parameter overview – setting ranges	31
8.1.1	MIG/MAG welding.....	31
8.1.2	MMA welding	31
9	Appendix C	32
9.1	Searching for a dealer.....	32

2 For your safety

2.1 Notes on the use of these operating instructions

DANGER

Working or operating procedures which must be closely observed to prevent imminent serious and even fatal injuries.

- Safety notes include the "DANGER" keyword in the heading with a general warning symbol.
- The hazard is also highlighted using a symbol on the edge of the page.

WARNING

Working or operating procedures which must be closely observed to prevent serious and even fatal injuries.

- Safety notes include the "WARNING" keyword in the heading with a general warning symbol.
- The hazard is also highlighted using a symbol in the page margin.

CAUTION

Working or operating procedures which must be closely observed to prevent possible minor personal injury.

- The safety information includes the "CAUTION" keyword in its heading with a general warning symbol.
- The risk is explained using a symbol on the edge of the page.

Technical aspects which the user must observe to avoid material or equipment damage.

Instructions and lists detailing step-by-step actions for given situations can be recognised via bullet points, e.g.:

- Insert the welding current lead socket into the relevant socket and lock.

2.2 Explanation of icons

Symbol	Description	Symbol	Description
	Indicates technical aspects which the user must observe.		Activate and release / Tap / Tip
	Switch off machine		Release
	Switch on machine		Press and hold
			Switch
	Incorrect / Invalid		Turn
	Correct / Valid		Numerical value – adjustable
	Input		Signal light lights up in green
	Navigation		Signal light flashes green
	Output		Signal light lights up in red

Symbol	Description	Symbol	Description
	Time representation (e.g.: wait 4 s / actuate)		Signal light flashes red
	Interruption in the menu display (other setting options possible)		
	Tool not required/do not use		
	Tool required/use		

2.3 Part of the complete documentation

These operating instructions are part of the complete documentation and valid only in combination with all other parts of these instructions! Read and observe the operating instructions for all system components, especially the safety instructions!

The illustration shows a general example of a welding system.

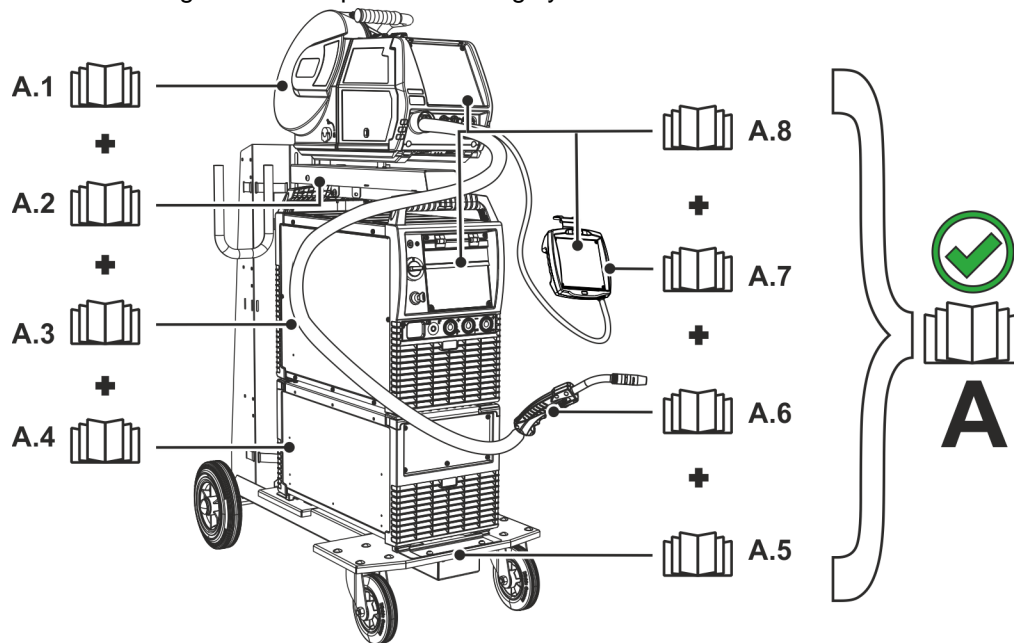

Figure 2-1

Item	Documentation
A.1	Wire feeder
A.2	Conversion instructions
A.3	Power source
A.4	Cooling unit, voltage converter, tool box etc.
A.5	Trolley
A.6	Welding torch
A.7	Remote control
A.8	Control
A	Complete documentation

3 Intended use

WARNING



Hazards due to improper usage!

The machine has been constructed to the state of the art and any regulations and standards applicable for use in industry and trade. It may only be used for the welding procedures indicated at the rating plate. Hazards may arise for persons, animals and material objects if the equipment is not used correctly. No liability is accepted for any damages arising from improper usage!

- The equipment must only be used in line with its designated purpose and by trained or expert personnel!
- Do not improperly modify or convert the equipment!

3.1 Use and operation solely with the following machines

This description may only be applied to machines with the M3.7X-L machine control.

3.2 Documents which also apply

- Operating instructions for the connected welding machines
- Documents of the optional expansions

3.3 Software version

These instructions apply to the following software version:

1.0.9.0



The software version of the machine control can be displayed in the machine configuration menu (menu Srv) > see 5.8 chapter.

4 Machine control – Operating elements

4.1 Overview of control sections

For description purposes, the machine control has been divided into two sections (A, B) to ensure maximum clarity.

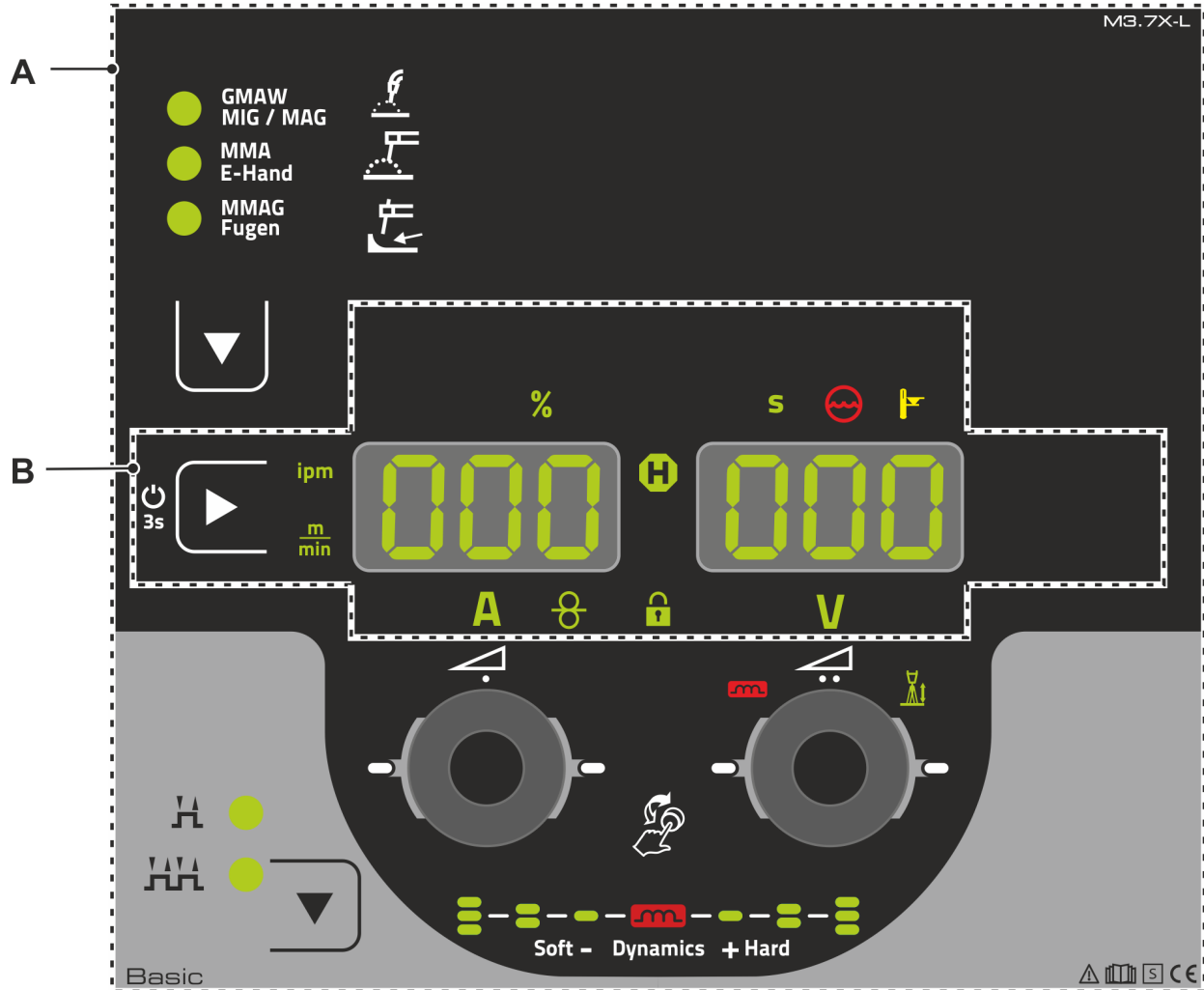

Figure 4-1

Item	Symbol	Description
1		Control section A > see 4.1.1 chapter
2		Control section B > see 4.1.2 chapter

4.1.1 Control section A

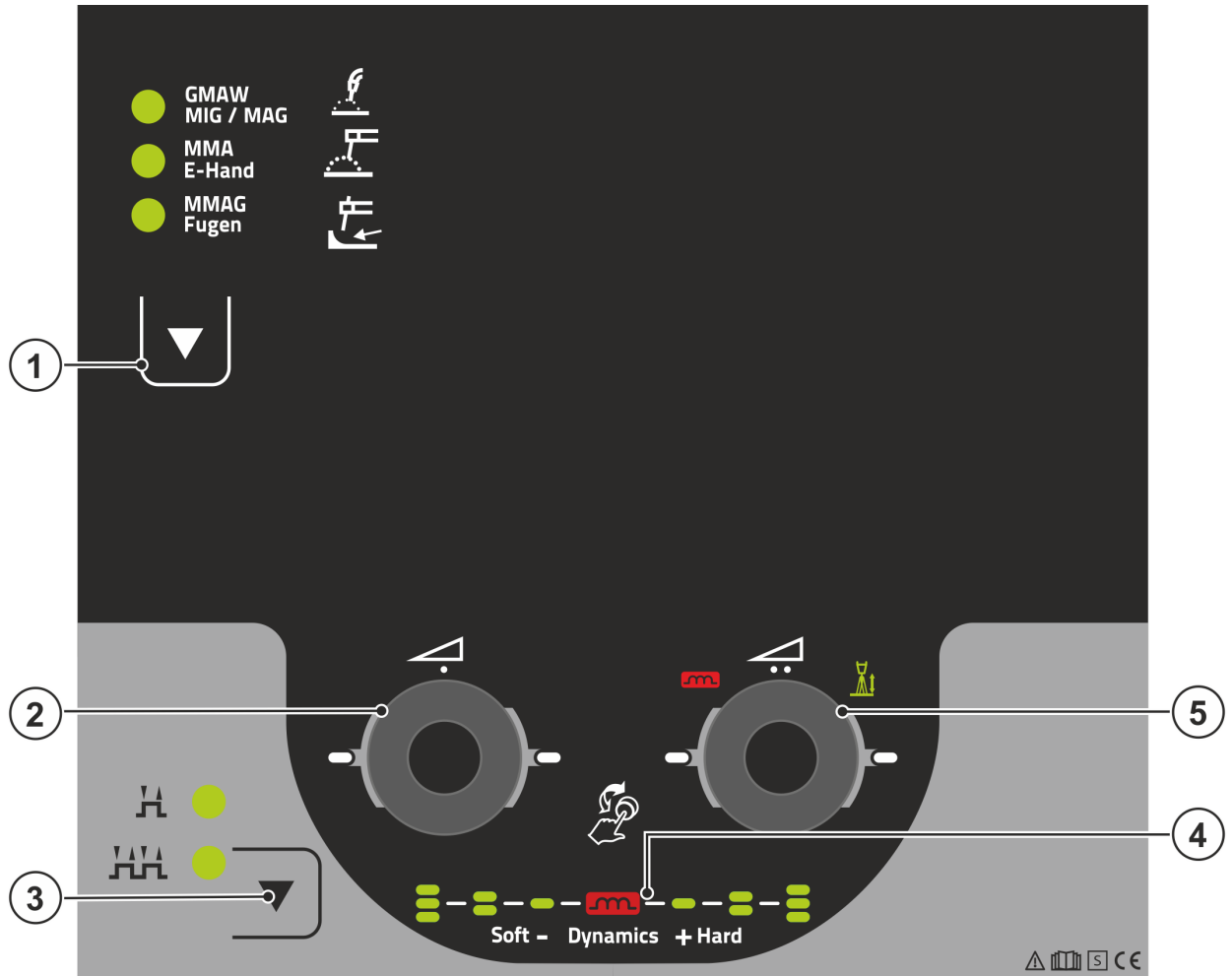

Figure 4-2

Item	Symbol	Description
1		Push-button, welding procedure ----- MIG/MAG welding ----- MMA welding ----- Air arc gouging
2		Click wheel wire feed speed/welding current <ul style="list-style-type: none"> ----- Setting the wire feed speed / welding current > see 5.4.2.2 chapter ----- Setting various parameters values depending on the preselection. The white signal lights (LED) around the rotary knob light up when setting is possible.
3		Select operating mode button H ----- Non-latched HH ----- Latched
4		Display of arc dynamics The height and orientation of the set arc dynamics are displayed.
5		Click wheel welding voltage <ul style="list-style-type: none"> ----- Welding voltage setting > see 5.4.2.2 chapter ----- Setting arc dynamics > see 5.4.2.3 chapter ----- Setting various parameters values depending on the preselection. The white signal lights (LED) around the rotary knob light up when setting is possible.

4.1.2 Control section B

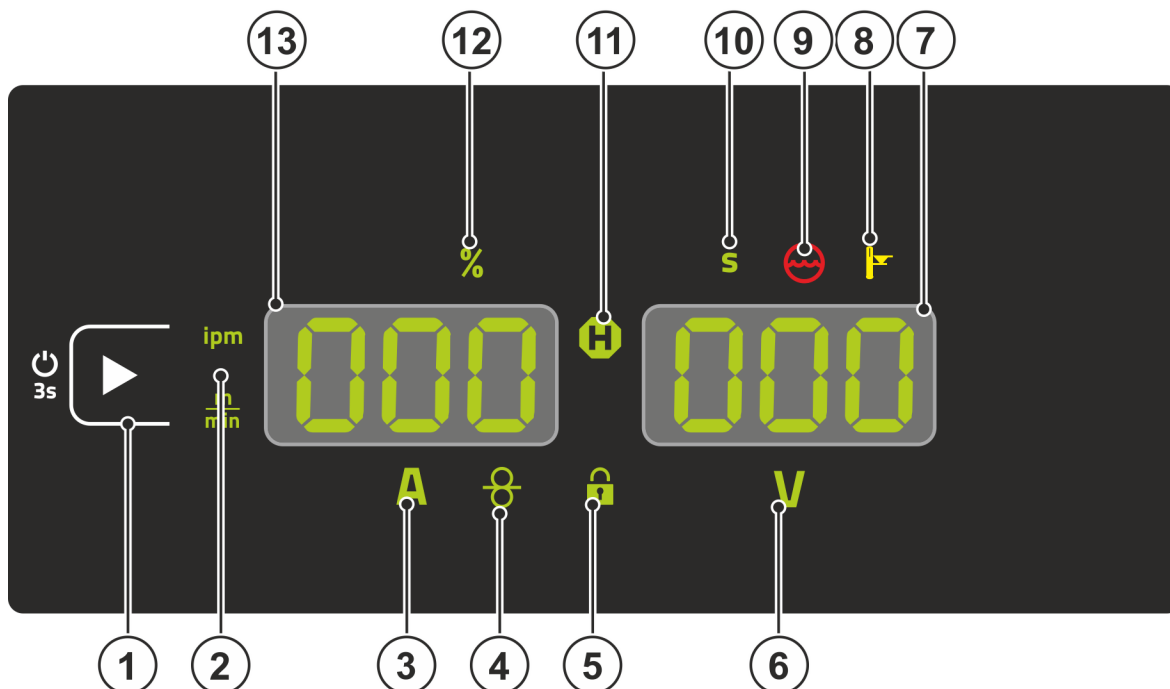

Figure 4-3

Item	Symbol	Description
1		Display left / Lock function push-button Switching the device display between various welding parameters. Signal lamps show the selected parameter. ⏻----- Press for 3 s to put the machine into lock function > see 4.3.4 chapter.
2		Wire feed speed unit signal light m/min --- Parameter value is displayed in meters per minute. ipm ----- Parameter value is displayed in inches per minute. Switching between metric or imperial system via special parameters "P29" > see 5.7 chapter.
3	A	Welding current signal light Display of the welding current in amperes.
4		Signal light, Wire speed Lights when the wire speed is shown on the display.
5		Lock function signal light Use display left / lock function push-button to switch on and off.
6	V	Signal light welding voltage Illuminates when the welding voltage is displayed in volts.
7		Display, right > see 4.2 chapter V ----- welding voltage
8		Excess temperature signal light / Welding torch cooling failure For error messages > see 6 chapter
9		Coolant fault signal light Signals pressure loss or low coolant level in the coolant circuit.
10	S	Second signal light The displayed value is displayed in seconds.
11	H	Status display signal light (Hold) Display of mean values across the entire welding process.

Item	Symbol	Description
12	%	Percent signal light The displayed value is displayed in percent.
13		Display, left > see 4.2 chapter AMP ----- welding current ----- wire feed speed

4.2 Welding data display

On the left and right of the parameter displays there are push-buttons for the selection of parameters. They are used to select the welding parameters to be displayed and their values.

Each time one the button is clicked, the display proceeds to the next parameter (signal lights indicate the selection). After reaching the last parameter, the system is restarted with the first one.

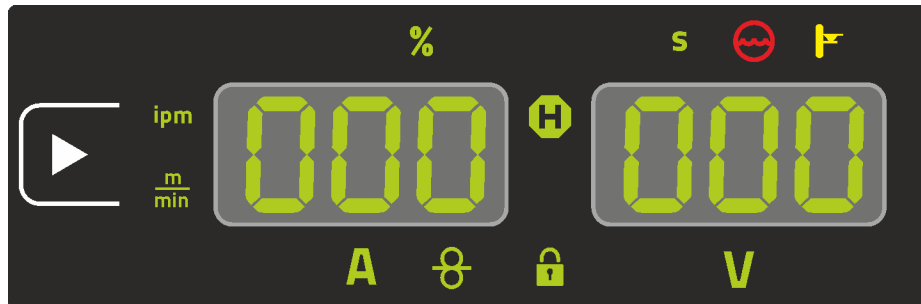

Figure 4-4

MIG/MAG

Parameter	Nominal values ^[1]	Actual values ^[2]	Hold values ^[3]
Welding current	✗	✓	✓
Wire feed speed	✓	✗	✗
Welding voltage	✓	✓	✓

MMA

Parameter	Nominal values ^[1]	Actual values ^[2]	Hold values ^[3]
Welding current	✓	✓	✗
Welding voltage	✓	✓	✗

When settings are changed (e.g. wire feed speed) the display immediately switches to the nominal value setting.

^[1] Nominal values (before welding)

^[2] Actual values (during welding)

^[3] Hold values (after welding, display of mean values for entire welding process)

4.3 Operating the machine control

4.3.1 Main screen

The machine control switches to the main screen again and again after it has been turned on or a parameter setting has been completed. This means that the previously selected settings (indicated by signal lights where applicable) are adopted and that the nominal value for the wire feed speed is shown in the left-hand welding data display. The right hand display shows the welding voltage (V).

4.3.2 Welding power setting

The welding power is adjusted with the wire feed speed / welding current rotary knob (click wheel). You can also adjust the parameters or settings in the different machine menus.

4.3.3 Changing basic settings (machine configuration menu)

The basic welding system functions can be adjusted in the machine configuration menu. Only experienced users should change the settings > see 5.8 chapter.

4.3.4 Lock function

The lock function protects against accidental adjustment of the device settings.

The user can switch the lock function on or off by pressing the button for a long time from each machine control or accessory component with the symbol .

5 Functional characteristics

5.1 Shielding gas volume settings

If the shielding gas setting is too low or too high, this can introduce air to the weld pool and may cause pores to form. Adjust the shielding gas quantity to suit the welding task!

- Slowly open the gas cylinder valve.
- Open the pressure regulator.
- Switch on the power source at the main switch.
- Trigger gas test > see 5.1.1 chapter function (welding voltage and wire feed motor remain switched off – no accidental arc ignition).
- Set the relevant gas quantity for the application on the pressure regulator.

Setting instructions

Welding process	Recommended shielding gas quantity
MAG welding	Wire diameter x 11.5 = l/min
MIG brazing	Wire diameter x 11.5 = l/min
MIG welding (aluminium)	Wire diameter x 13.5 = l/min (100 % argon)
TIG	Gas nozzle diameter in mm corresponds to l/min gas throughput

Helium-rich gas mixtures require a higher gas volume!

The table below can be used to correct the gas volume calculated where necessary:

Shielding gas	Factor
75% Ar/25% He	1.14
50% Ar/50% He	1.35
25% Ar/75% He	1.75
100% He	3.16

5.1.1 Gas test

The operating elements are installed under the protective cap of wire feed mechanism.

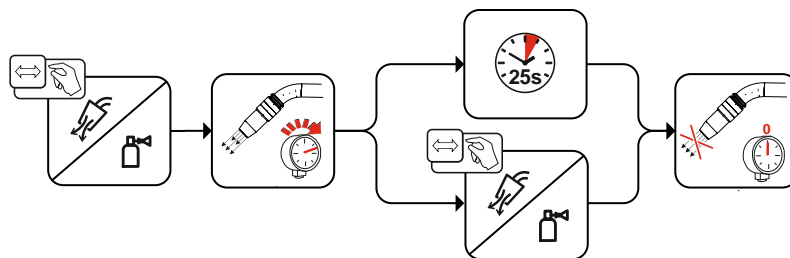

Figure 5-1

5.1.2 Purge hose package

The operating elements are installed under the protective cap of wire feed mechanism.

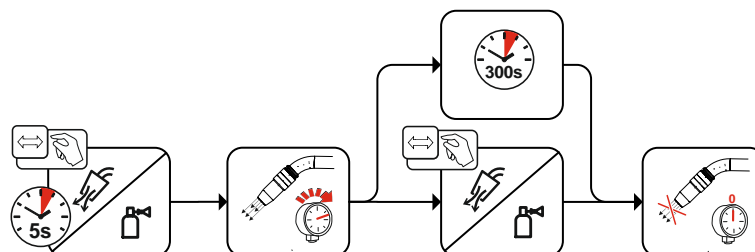

Figure 5-2

5.2 Wire thread

The wire inching function is used for potential- and gas-free inching of the wire electrode after the wire spool change. By pressing and holding the wire inching button for a long time, the wire inching speed increases in a ramp function (special parameter P1 > see 5.7.1.1 chapter) from 1 m/min to the set maximum value. The maximum value is set by simultaneously pressing the wire inching button and turning the left click wheel.

The operating elements are installed under the protective cap of wire feed mechanism.

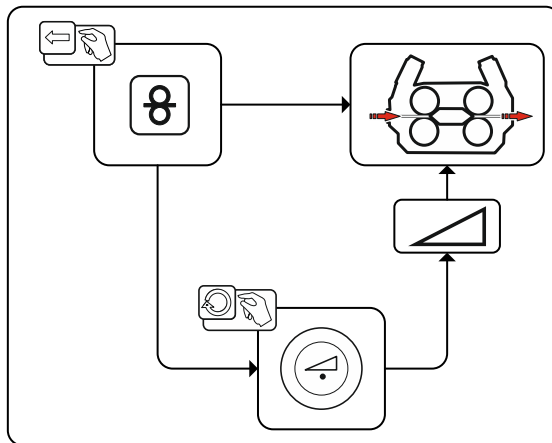

Figure 5-3

5.3 Wire return

The wire return function is used to retract the wire electrode without tension and protection gas. By simultaneously pressing and holding the wire inching and gas test buttons, the wire return speed increases in a ramp function (special parameter P1 > see 5.7.1.1 chapter) from 1 m/min to the set maximum value. The maximum value is set by simultaneously pressing the wire inching button and turning the left click wheel.

During the process, the wire spool must be turned by hand clockwise to wind up the wire electrode again. The operating elements are installed under the protective cap of wire feed mechanism.

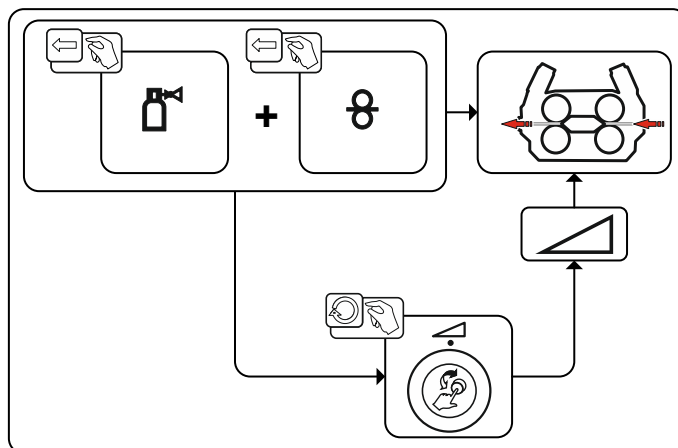

Figure 5-4

5.4 MIG/MAG welding

5.4.1 Welding task selection

The following steps have to be carried out to select the welding job:

- Select welding procedure.
- Select operating mode.
- Set welding power (wire feed speed and welding voltage).
- Correct dynamics if necessary.

5.4.2 Welding procedure

Select welding procedure MIG/MAG welding.

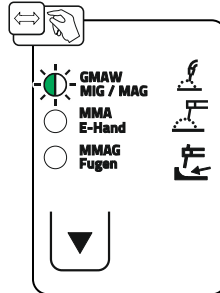

Figure 5-5

5.4.2.1 Operating mode

The operating mode determines the process sequence controlled by the welding torch. Detailed descriptions of the operating modes > see 5.4.4 chapter.

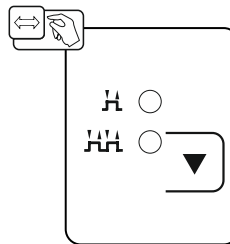

Figure 5-6

5.4.2.2 Welding power (operating point)

This control uses the principle of twin-knob operation. To specify the operating point, only the wire feed speed and the welding voltage are selected according to the type of material, shielding gas, material thickness, and wire diameter (see also table setting instructions in the Appendix > see 7.1 chapter).

Example of use:

1. Material type: Solid wire SG2/3
2. Shielding gas: Ar-82 / CO₂-18 (M21)
3. Materialdicke: 3,0 mm / 0.12 inch
4. Wire diameter: 1,0 mm / 0.04 inch
5. Wire feed speed: 5,1 m/min / 201 ipm
Welding voltage: 19,0 V

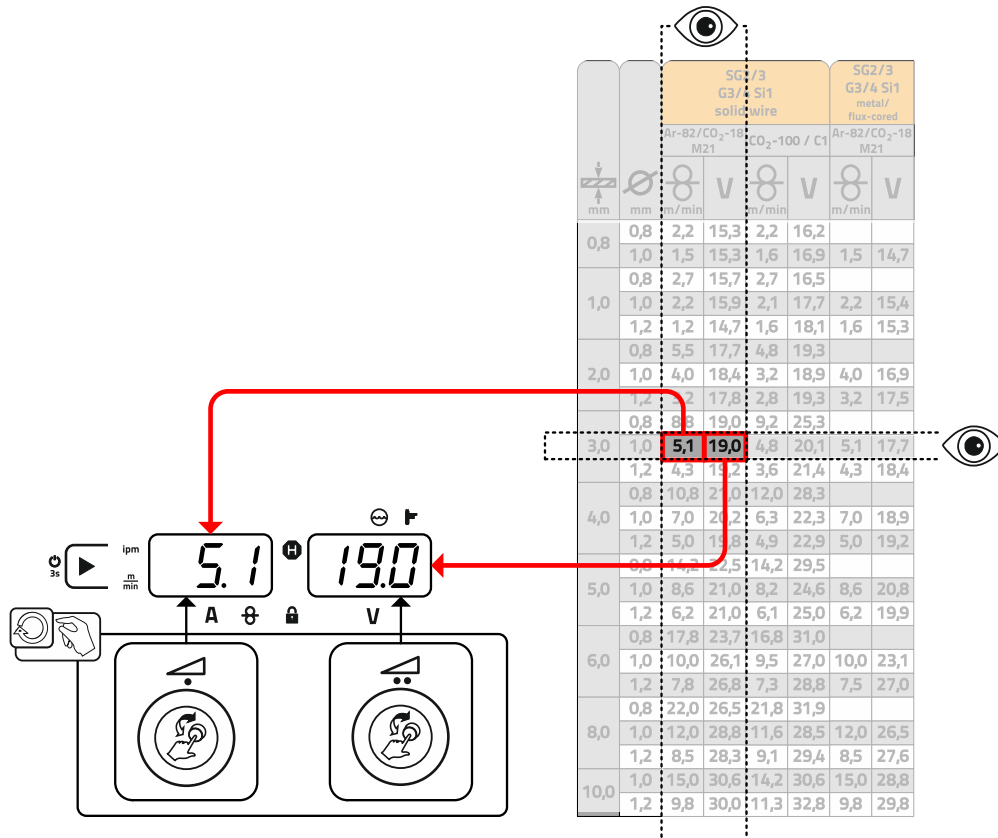

Figure 5-7

5.4.2.3 Arc dynamics (choke effect)

This function can be used to adjust the arc between a narrow, hard arc with deep penetration (positive values) and a wide and soft arc (negative values). In addition, the selected settings are displayed with signal lights below the rotary knobs.

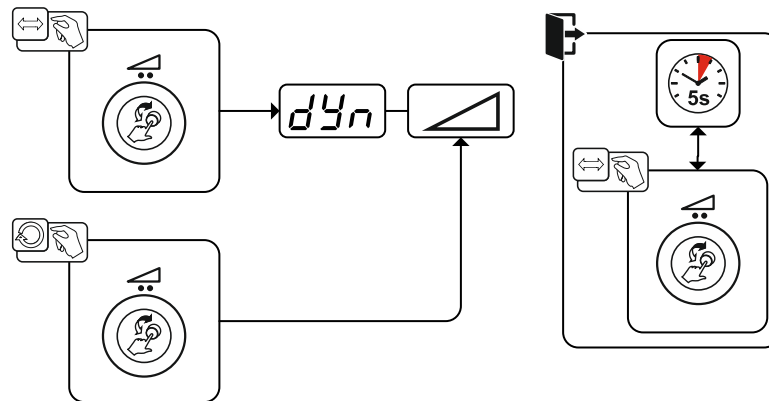

Figure 5-8

5.4.3 Expert menu (MIG/MAG)

The Expert menu has adjustable parameters stored that don't require regular setting. The number of parameters shown may be limited, e.g. if a function is deactivated.

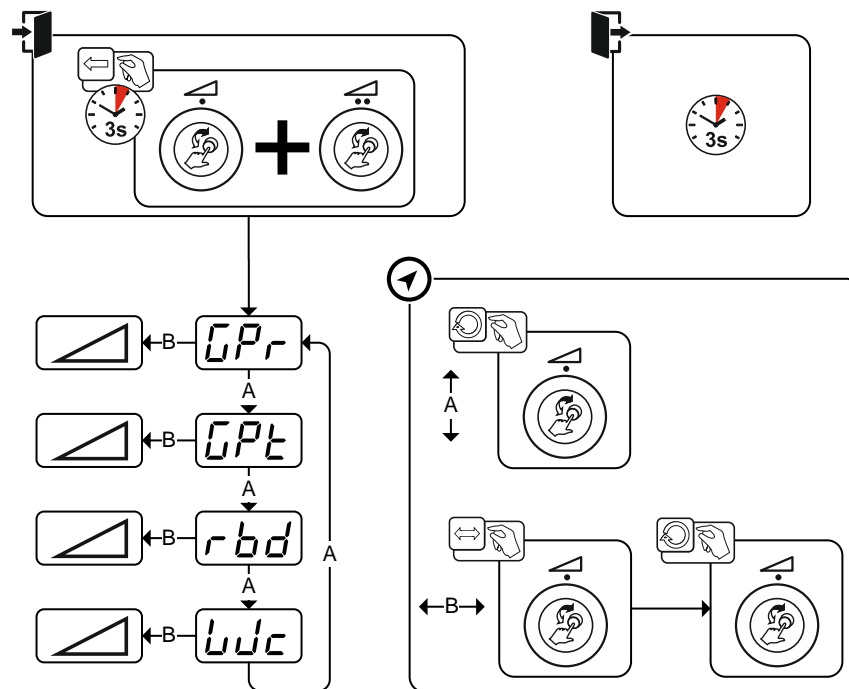

Figure 5-9

Display	Setting/selection
	Gas pre-flow time
	Gas post-flow time
	Burn-back time > see 5.4.3.1 chapter •-----Increase value > increase wire burn-back •-----Decrease value > decrease wire burn-back
	Wire creep











5.4.3.1 Burn-back

The wire burn-back parameter prevents the sticking of the wire electrode in the weld pool or at the contact tip at the end of the welding process. The value is optimally preset for a variety of applications (but can be adjusted if necessary). The adjustable value stands for the time until the power source switches off the welding current after the welding process has been stopped.

Welding wire behaviour	Setting instructions
Wire electrode is sticking in the weld pool.	Increase value
Wire electrode is sticking on the contact tip or large ball formation on the wire electrode	Reduce value

5.4.4 Operating modes (functional sequences)

5.4.4.1 Explanation of signs and functions

Symbol	Meaning
	Press torch trigger
	Release torch trigger
	Tap torch trigger (briefly press and release)
	Shielding gas is flowing
I	Welding power
	Wire electrode is being fed
	Wire creep
	Wire burn-back
	Gas pre-flow
	Gas post-flow
	Non-latched
	Latched
t	Time

5.4.4.2 Automatic cut-out



The welding machine ends the ignition process or the welding process with an

- **ignition fault (no welding current flows within 5 s after the start signal)**
- **arc interruption (arc is interrupted for longer than 5 s)**

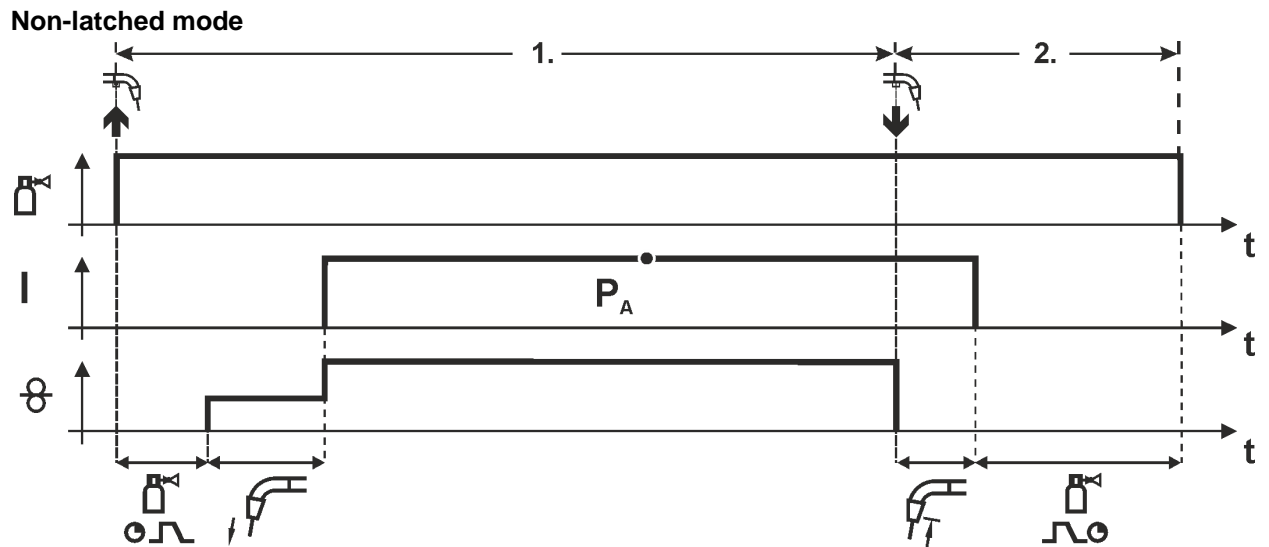

Figure 5-10

Step 1

- Press and hold torch trigger.
- Shielding gas is expelled (gas pre-flows).
- Wire feed motor runs at "creep speed".
- Arc ignites after the wire electrode makes contact with the workpiece; welding current flows.
- Change over to pre-selected wire speed.

Step 2

- Release torch trigger.
- WF motor stops.
- Arc is extinguished after the preselected wire burn-back time expires.
- Gas post-flow time elapses.

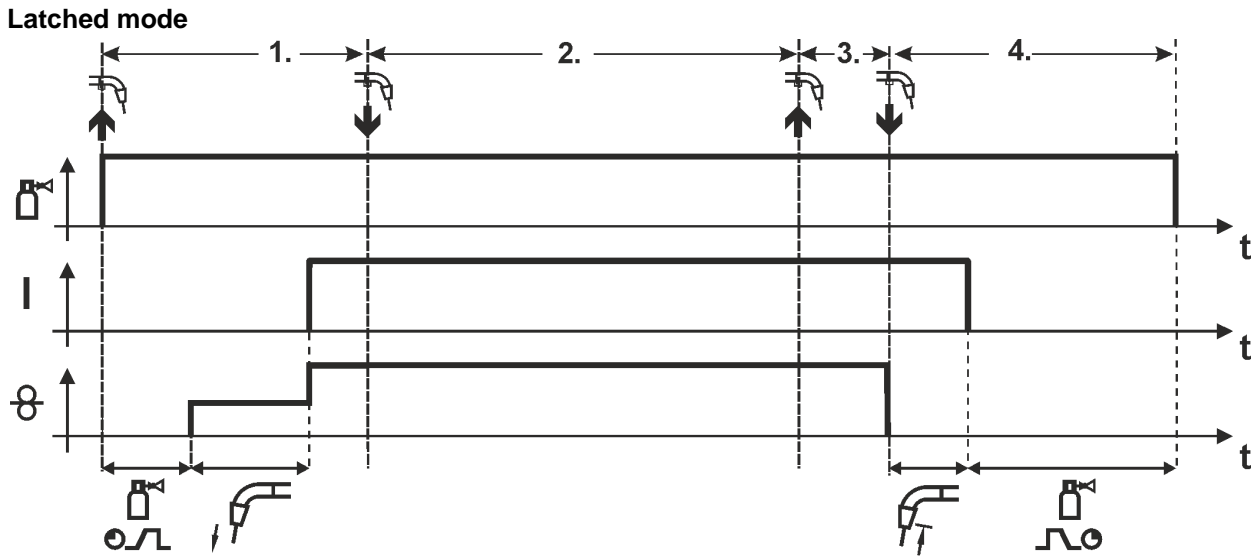

Figure 5-11

Step 1

- Press and hold torch trigger
- Shielding gas is expelled (gas pre-flows)
- Wire feed motor runs at “creep speed”.
- Arc ignites after the wire electrode makes contact with the workpiece; welding current flows.
- Change over to pre-selected WF speed (main program P_A).

Step 2

- Release torch trigger (no effect)

Step 3

- Press torch trigger (no effect)

Step 4

- Release torch trigger
- WF motor stops.
- Arc is extinguished after the preselected wire burn-back time expires.
- Gas post-flow time elapses.

5.4.5 Standard MIG/MAG torch

The MIG welding torch trigger is essentially used to start and stop the welding process.

Operating elements	Functions
 Torch trigger	• Start/stop welding

5.4.5.1 Switching between Push/Pull and intermediate drive

WARNING



Do not carry out any unauthorised repairs or modifications!
To avoid injury and equipment damage, the unit must only be repaired or modified by specialist, skilled persons!
The warranty becomes null and void in the event of unauthorised interference.

- Appoint only skilled persons for repair work (trained service personnel)!

⚠ WARNING



Dangers resulting from failure to perform test after conversion!
Before reconnection, "Inspection and Testing during Operation" according to IEC/BS EN 60974-4 "Arc welding systems – Inspection and Testing during Operation" has to be performed!

- Perform test to IEC / DIN EN 60974-4!

The plugs are located directly on the M3.7X printed circuit board.

Plug	Function
on X24	Operation with Push/Pull welding torch (factory setting)
on X23	Operation with intermediate drive

5.5 MMA welding

5.5.1 Welding task selection

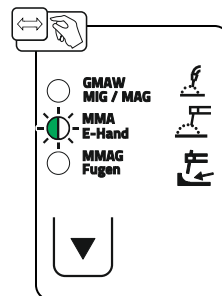

Figure 5-12

5.5.2 Welding current setting

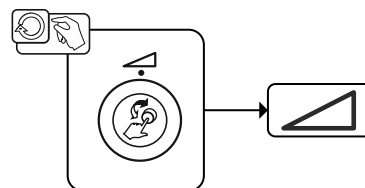

Figure 5-13

5.5.3 Arcforce

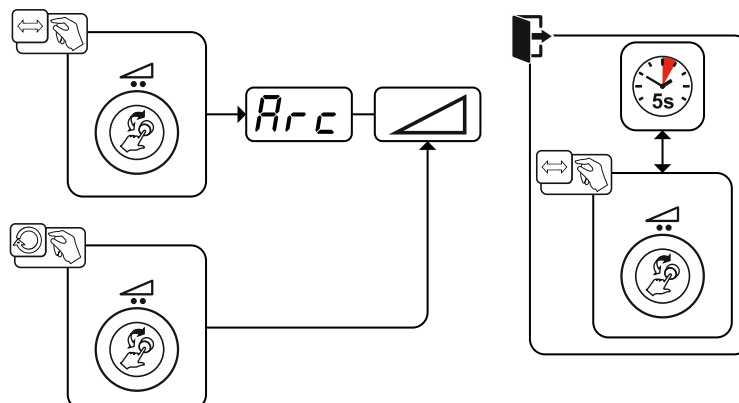

Figure 5-14

Setting:

- Negative values: rutile electrode types
- Values at zero: basic electrode types
- Positive values: cellulose electrode types

5.5.4 Hotstart

The function hot start ensures a secure igniting of the arc and a sufficient heating to the still cold parent metal at the beginning of the welding process. The ignition takes place here with increased current (hot start current) over a certain time (hot start time).

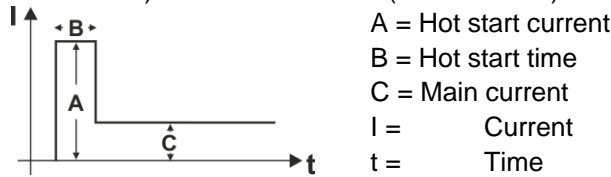
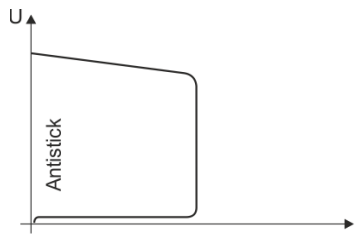

Figure 5-15

5.5.5 Antistick



The Antistick feature prevents the electrode from annealing.

Should the electrode stick despite the Arcforce feature, the machine automatically switches to the minimum current within approx. one second. This prevents the electrode from annealing. Check the welding current setting and correct for the welding task in hand.

Figure 5-16

5.6 Air arc gouging

5.6.1 Welding task selection

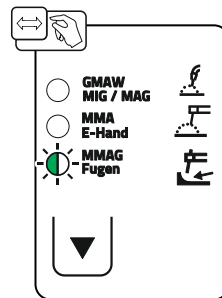

Figure 5-17

5.6.2 Welding current setting

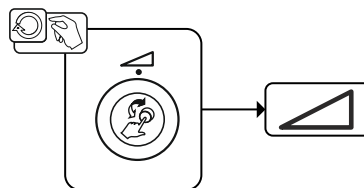

Figure 5-18

5.7 Special parameters (advanced settings)

Special parameters (P1 to Pn) are applied for customer-specific configuration of machine functions. This allows the user maximum flexibility in optimising their requirements.

These settings are not configured directly on the machine control since a regular setting of the parameters is generally not required. The number of selectable special parameters can deviate between the machine controls used in the welding system (also see the relevant standard operating instructions).

If required, the special parameters can be reset to the factory settings > see 5.7.2 chapter.

5.7.1 Selecting, changing and saving parameters

Figure 5-19

Display	Setting/selection
P 1	Wire inching / wire return ramp time 0 =-----normal inching (10 s ramp time) 1 =-----fast inching (3 s ramp time) (ex works)
P 9	Tapping start for latched and special latched operation 0 =-----no 4-cycle inching start 1 =-----4-cycle inching start possible (ex works)
P 15	HOLD function 0 =-----HOLD values are not displayed 1 =-----HOLD values are displayed (Ex works)
P24	Correction or nominal voltage display 0 =-----Correction voltage display (ex works). 1 =-----Absolute nominal voltage display.
P29	Unit system > see 5.7.1.5 chapter 0 =-----metric system (ex works) 1 =-----Imperial system

5.7.1.1 Ramp time for wire inching (P1)

The wire inching starts with a speed 1.0 m/min for 2 secs. It is subsequently increased to a ramp function to 6.0 m/min. The ramp time can be set between two ranges.

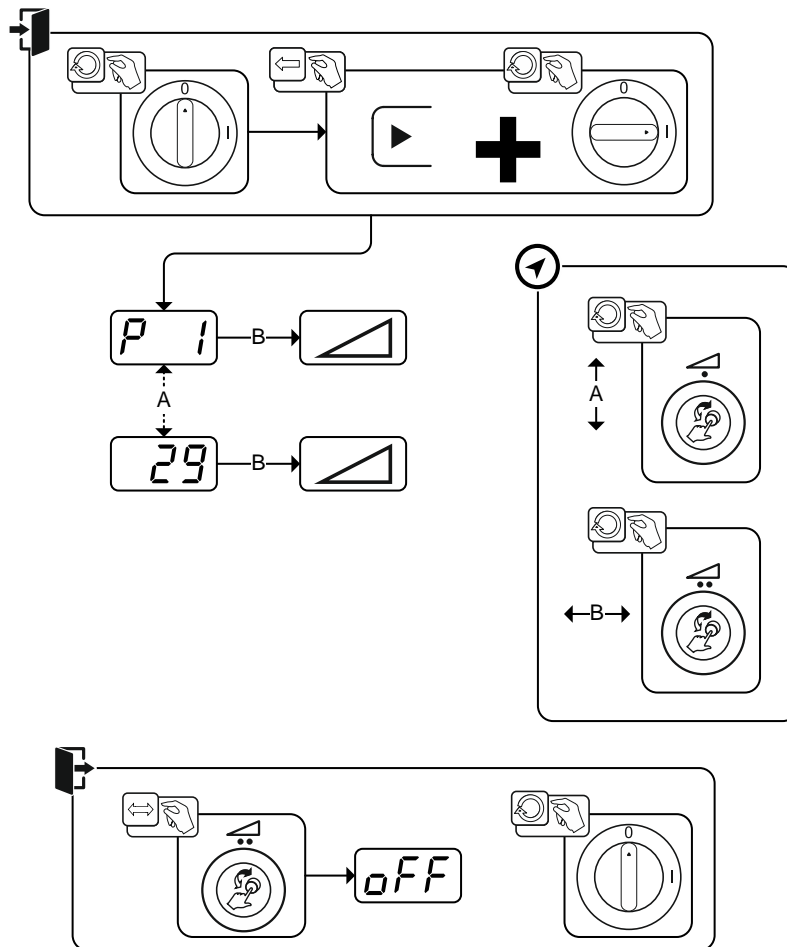
During wire inching, the speed can be changed by means of the welding power rotary knob. Changing the speed has no effect on the ramp time.

5.7.1.2 Latched/special-latched tap start (P9)

In latched – tap start – operating mode it is possible to switch straight to the second step by tapping the torch trigger; it is not necessary for current to be flowing.

The welding can be halted by pressing the torch trigger for a second time.

5.7.1.3 Hold function (P15)

Hold function active (P15 = 1)

- Mean values for the last main program parameters used for welding are displayed.

Hold function not active (P15 = 0)

- Setpoint values for the main program parameters are displayed.

5.7.1.4 Correction or nominal voltage display (P24)

When setting the arc correction using the right-hand rotary knob the display will either show the correction voltage +- 9.9 V (ex works) or the absolute nominal voltage.

5.7.1.5 Units system (P29)

Function not active

- Metric metric units are displayed.

Function active

- Imperial units are displayed.

5.7.2 Reset to factory settings

All special parameters saved by the user will be overwritten by the factory settings!

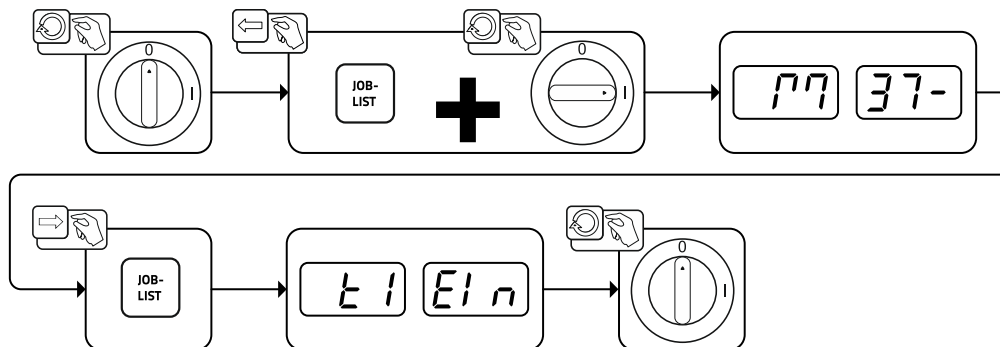

Figure 5-20

5.8 Machine configuration menu
5.8.1 Selecting, changing and saving parameters

Figure 5-21

Display	Setting/selection
	Lead resistance 1 Lead resistance for the first welding circuit 0 mΩ–60 mΩ (8 mΩ ex works).
	Lead resistance 2 Lead resistance for the second welding circuit 0 mΩ–60 mΩ (8 mΩ ex works).
	Only qualified service personnel may change the parameters!
	Only qualified service personnel may change the parameters!
	Time-based power-saving mode > see 5.8.3 chapter Time to activation of the power-saving mode in case of inactivity. Setting = disabled or numerical value 5– 60 min. (ex works: 20).
	Service menu Modifications to the service menu may only be carried out by authorised maintenance staff!

5.8.2 Aligning the cable resistance

The resistance value of the cables can be set directly or it can be adjusted through the power source. The power source cable resistance value is set to 8 mΩ when delivered. This value corresponds to an earth cable length of 5 m, an intermediate hose package length of 1.5 m and a water-cooled welding torch length of 3 m. A +/- welding voltage correction is therefore required to optimise the welding properties for other hose package lengths. By realigning the cable resistance, the voltage correction value can be set close to zero again. The electric cable resistance should be realigned whenever an accessory component such as the welding torch or the intermediate hose package has been changed.

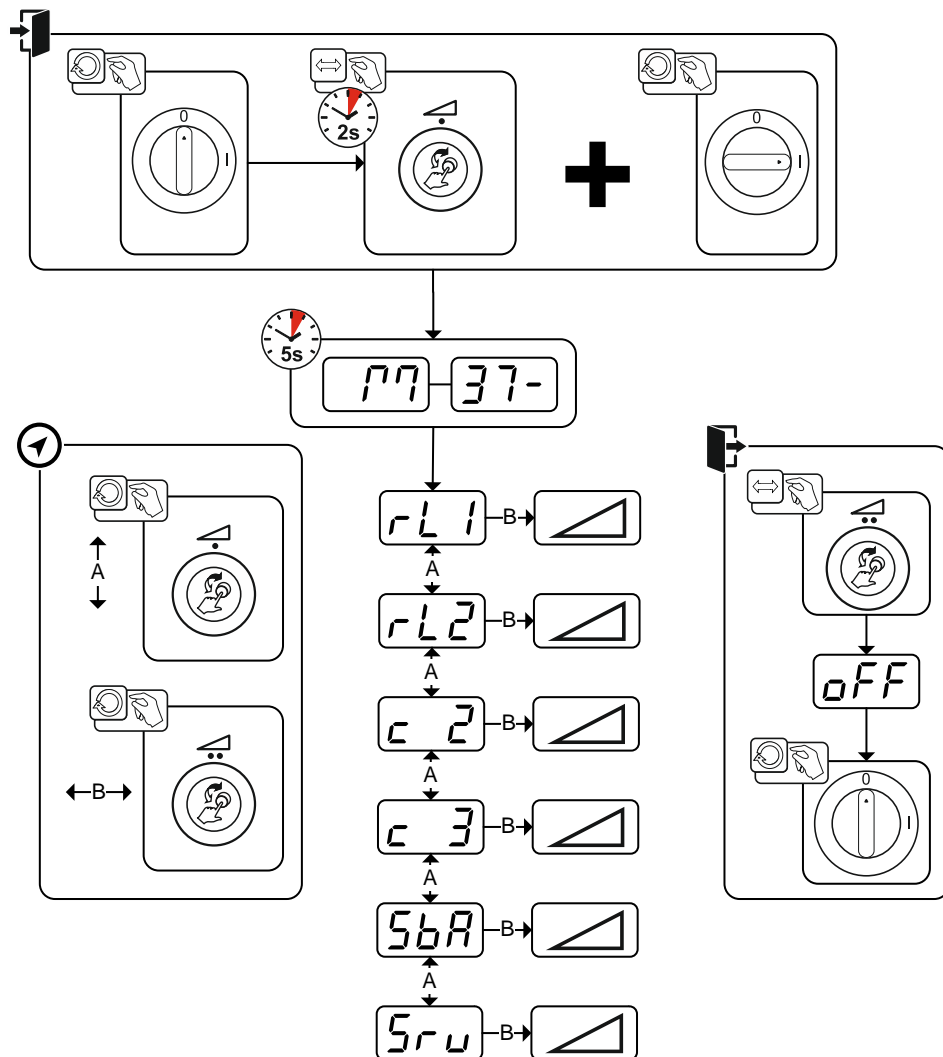
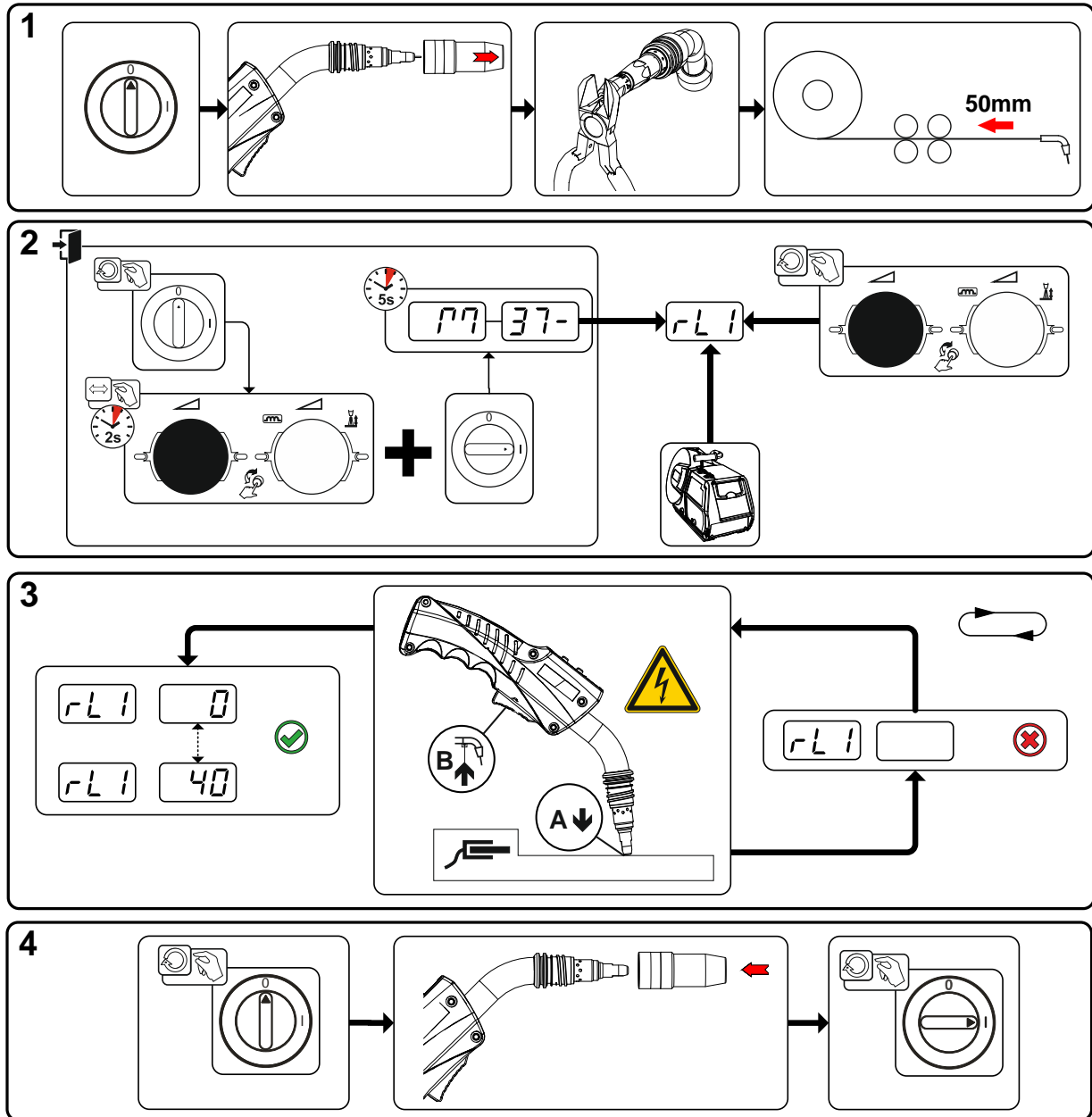

Figure 5-22

1 Preparation

- Switch off the welding machine.
- Unscrew the gas nozzle from the welding torch.
- Trim the welding wire so that it is flush with the contact tip.
- Retract the welding wire a little (approx. 50 mm) on the wire feeder. There should be no more welding wire in the contact tip at this point.

2 Configuration

- Press and hold the “Welding power rotary knob”; at the same time switch on the welding machine (at least 2 s). Release the rotary knob (after a further 5 s the device will switch to the cable resistance 1 parameter).
- Turn the “Welding power rotary knob” to select the appropriate parameter. The “rL1” parameter has to be adjusted for all machine combinations.

3 Alignment/Measurement

- Applying slight pressure, put the welding torch in place with the contact tip on a clean, purged location on the workpiece and then press the torch trigger for approx. 2 seconds. A short-circuit current will flow briefly, which is used to determine and display the cable resistance. The value can be between 0 mΩ and 40 mΩ. The new value is immediately saved without requiring further confirmation. If no value is shown on the right-hand display, then measurement failed. The measurement must be repeated.

4 Restoring welding standby mode

- Switch off the welding machine.
- Screw the gas nozzle onto the welding torch.
- Switch on the welding machine.
- Insert the welding wire again.

5.8.3 Power-saving mode (Standby)

You can activate the power-saving mode by setting a parameter in the machine configuration menu (time-controlled power-saving mode [5.6.11](#)) > see 5.8 chapter.

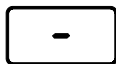

When power-saving mode is activated, the machine displays show the horizontal digit in the centre of the display only.

Pressing any operating element (e.g. turning a rotary knob) deactivates power-saving mode and the machine is ready for welding again.

6 Rectifying faults

All products are subject to rigorous production checks and final checks. If, despite this, something fails to work at any time, please check the product using the following flowchart. If none of the fault rectification procedures described leads to the correct functioning of the product, please inform your authorised dealer.

6.1 Display machine control software version

The query of the software versions only serves to inform the authorised service staff. It is available in the machine configuration menu > see 5.8 chapter.

6.2 Error messages (power source)

A welding machine error will be signalled by an error code (see table) on the control display. In the event of an error, the power unit shuts down.

The display of possible error numbers depends on the machine version (interfaces/functions).





- Document machine errors and inform service staff as necessary.
- If multiple errors occur, these are displayed in succession.

Error (Err)	Category			Possible cause	Remedy
	a)	b)	c)		
1	-	-	x	Mains overvoltage	Check the mains voltages and compare with the welding machine connection voltages
2	-	-	x	Mains undervoltage	
3	x	-	-	Welding machine excess temperature	Allow the machine to cool down (mains switch to "1")
4	x	x	-	Coolant error	Fill coolant Turn on pump shaft (coolant pump) Check air cooling unit overcurrent trip
5	x	-	-	Wire feeder/tachometer error	Check the wire feeder Tachogenerator is not emitting a signal, M3.51 defective > inform Service.
6	x	-	-	Shielding gas error	Check shielding gas supply (for machines with shielding gas monitoring)
7	-	-	x	Secondary overvoltage	Inverter error > inform Service
8	-	-	x	Wire error	Separate the electrical connection between welding wire and casing or an earthed object
9	x	-	-	Quick shut-down	Rectify error on robot (Interface for automated welding)
10	-	x	-	Arc interruption	Check wire feeding (Interface for automated welding)
11	-	x	-	Ignition error (after 5 s)	Check wire feeding (Interface for automated welding)
13	x	-	-	Emergency stop deactivation	Check the emergency stop switch at the interface for automated welding
14	-	x	-	Wire feeder detection	Check cable connections
				ID number allocation error (2DV)	Correct ID numbers
15	-	x	-	Second wire feeder detection	Check cable connections
16	-	-	x	Open circuit voltage reduction error (VRD)	Inform Service.
17	-	x	x	Overcurrent detection on wire feeder	Check ease of wire feeding
18	-	x	x	Tachogenerator signal error	Check the connection and particularly the tachogenerator of the second wire feeder (slave drive).
56	-	-	x	Mains phase failure	Check mains voltages

Error (Err)	Category			Possible cause	Remedy
	a)	b)	c)		
59	-	-	x	Machine incompatible	Check machine usage
60	-	-	x	Software update required	Inform Service.

Categories legend (resetting the error)

- a) The error message will disappear once the error has been rectified.
 b) The error message can be reset by pressing a push-button:

Welding machine control	Push-button
RC1 / RC2	
Expert	
Expert 2.0 / Expert XQ 2.0	
CarExpert / Progress (M3.11)	
alpha Q / Concept / Basic / Basic S / Synergic / Synergic S / Progress (M3.71) / Picomig 355	not possible

- c) The error message can only be reset by switching the machine off and on again.

The shielding gas error (Err 6) can be reset by pressing the "Welding parameters" key button.

7 Appendix A

7.1 Setting instructions

		Basic		mm				Basic		inch		
 mm	 mm	SG2/3 G3/4 Si1 solid wire				SG2/3 G3/4 Si1 metal/ flux-cored						
		Ar-82/CO ₂ -18 M21		CO ₂ -100 / C1		Ar-82/CO ₂ -18 M21		Ar-82/CO ₂ -18 M21				
			V		V		V		V			
		m/min		m/min		m/min		ipm		ipm		
0,8	0,8	2,2	15,3	2,2	16,2			.030	087	15.3	087	16.2
	1,0	1,5	15,3	1,6	16,9	1,5	14,7	.040	059	15.3	063	16.9
1,0	0,8	2,7	15,7	2,7	16,5			.030	106	15.7	106	16.5
	1,0	2,2	15,9	2,1	17,7	2,2	15,4	.040	087	15.9	083	17.7
	1,2	1,2	14,7	1,6	18,1	1,6	15,3	.045	047	14.7	063	18.1
2,0	0,8	5,5	17,7	4,8	19,3			.030	217	17.7	189	19.3
	1,0	4,0	18,4	3,2	18,9	4,0	16,9	.040	157	18.4	126	18.9
	1,2	3,2	17,8	2,8	19,3	3,2	17,5	.045	126	17.8	110	19.3
3,0	0,8	8,8	19,0	9,2	25,3			.030	346	19.0	362	25.3
	1,0	5,1	19,0	4,8	20,1	5,1	17,7	.040	201	19.0	189	20.1
	1,2	4,3	19,2	3,6	21,4	4,3	18,4	.045	169	19.2	142	21.4
4,0	0,8	10,8	21,0	12,0	28,3			.030	425	21.0	472	28.3
	1,0	7,0	20,2	6,3	22,3	7,0	18,9	.040	276	20.2	248	22.3
	1,2	5,0	19,8	4,9	22,9	5,0	19,2	.045	197	19.8	193	22.9
5,0	0,8	14,2	22,5	14,2	29,5			.030	559	22.5	559	29.5
	1,0	8,6	21,0	8,2	24,6	8,6	20,8	.040	339	21.0	323	24.6
	1,2	6,2	21,0	6,1	25,0	6,2	19,9	.045	244	21.0	240	25.0
6,0	0,8	17,8	23,7	16,8	31,0			.030	701	23.7	661	31.0
	1,0	10,0	26,1	9,5	27,0	10,0	23,1	.040	394	26.1	374	27.0
	1,2	7,8	26,8	7,3	28,8	7,5	27,0	.045	307	26.8	287	28.8
8,0	0,8	22,0	26,5	21,8	31,9			.030	866	26.5	858	31.9
	1,0	12,0	28,8	11,6	28,5	12,0	26,5	.040	472	28.8	457	28.5
	1,2	8,5	28,3	9,1	29,4	8,5	27,6	.045	335	28.3	358	29.4
10,0	1,0	15,0	30,6	14,2	30,6	15,0	28,8	.040	591	30.6	559	30.6
	1,2	9,8	30,0	11,3	32,8	9,8	29,8	.045	386	30.0	445	32.8

Figure 7-1

8 Appendix B

8.1 Parameter overview – setting ranges

8.1.1 MIG/MAG welding

Name	Display			Setting range	
	Code	Standard (ex works)	Unit	Min.	Max.
Gas pre-flow time	[GPr]	0,2	s	0	- 20
Gas post-flow time	[GPt]	0,2	s	0	- 20
Burn-back time	[rbd]	19		0	- 333
Wire creep	[WJc]	30	%	10	100

8.1.2 MMA welding

Name	Display			Setting range	
	Code	Standard (ex works)	Unit	Min.	Max.
Arcforce	[Arc]	0		-40	- 40

9 Appendix C

9.1 Searching for a dealer

Sales & service partners
www.ewm-group.com/en/specialist-dealers



"More than 400 EWM sales partners worldwide"