



EN

Control

T4.04 - Tetrix AC/DC Smart 2.0

T4.10 - Tetrix AC/DC Smart 2.0

099-00T404-EW501

Observe additional system documents!

02.07.2020

**Register now
and benefit!
Jetzt Registrieren
und Profitieren!**

www.ewm-group.com



General instructions

WARNING



Read the operating instructions!

The operating instructions provide an introduction to the safe use of the products.

- Read and observe the operating instructions for all system components, especially the safety instructions and warning notices!
- Observe the accident prevention regulations and any regional regulations!
- The operating instructions must be kept at the location where the machine is operated.
- Safety and warning labels on the machine indicate any possible risks. Keep these labels clean and legible at all times.
- The machine has been constructed to state-of-the-art standards in line with any applicable regulations and industrial standards. Only trained personnel may operate, service and repair the machine.
- Technical changes due to further development in machine technology may lead to a differing welding behaviour.

In the event of queries on installation, commissioning, operation or special conditions at the installation site, or on usage, please contact your sales partner or our customer service department on +49 2680 181-0.

A list of authorised sales partners can be found at www.ewm-group.com/en/specialist-dealers.

Liability relating to the operation of this equipment is restricted solely to the function of the equipment. No other form of liability, regardless of type, shall be accepted. This exclusion of liability shall be deemed accepted by the user on commissioning the equipment.

The manufacturer is unable to monitor whether or not these instructions or the conditions and methods are observed during installation, operation, usage and maintenance of the equipment.

An incorrectly performed installation can result in material damage and injure persons as a result. For this reason, we do not accept any responsibility or liability for losses, damages or costs arising from incorrect installation, improper operation or incorrect usage and maintenance or any actions connected to this in any way.

© EWM AG

Dr. Günter-Henle-Strasse 8
56271 Mündersbach Germany
Tel.: +49 2680 181-0, Fax: -244
Email: info@ewm-group.com
www.ewm-group.com

The copyright to this document remains the property of the manufacturer.

Copying, including extracts, only permitted with written approval.

The content of this document has been prepared and reviewed with all reasonable care. The information provided is subject to change; errors excepted.

1 Contents

1	Contents	3
2	For your safety	5
2.1	Notes on using these operating instructions.....	5
2.2	Explanation of icons.....	5
2.3	Part of the complete documentation	7
3	Intended use	8
3.1	Use and operation solely with the following machines	8
3.2	Documents which also apply	8
3.3	Software version	8
4	Machine control – Operating elements	9
4.1	Overview of control sections	9
4.1.1	Control section A	10
4.1.2	Control section B	11
4.2	Machine display	12
4.2.1	Setting the welding current (absolute/percentage).....	12
4.3	Operating the machine control.....	12
4.3.1	Main screen	12
4.3.2	Welding power setting	12
4.3.3	Welding parameter setting in the operation sequence.....	13
4.3.4	Setting advanced welding parameters (Expert menu)	13
4.3.5	Changing basic settings (machine configuration menu)	13
5	Functional characteristics	14
5.1	TIG welding.....	14
5.1.1	Setting the shielding gas volume (gas test)/rinse hose package	14
5.1.1.1	Automatic gas post-flow	14
5.1.2	Welding task selection.....	15
5.1.3	AC welding	16
5.1.3.1	AC balance (optimise cleaning effect and penetration characteristics).....	16
5.1.3.2	AC commutation optimisation	16
5.1.3.3	Alternating current waveforms	17
5.1.4	Arc ignition.....	18
5.1.4.1	HF ignition	18
5.1.4.2	Liftarc	18
5.1.4.3	Automatic cut-out	18
5.1.5	Operating modes (functional sequences)	19
5.1.5.1	Explanation of symbols	19
5.1.5.2	Non-latched mode.....	20
5.1.5.3	Latched mode	21
5.1.5.4	spotArc.....	22
5.1.5.5	spotmatic.....	24
5.1.5.6	Non-latched operation, version C	25
5.1.6	Average value pulse welding.....	26
5.1.6.1	Pulsed welding in the upslope and downslope phases	27
5.1.6.2	Automated pulses	27
5.1.7	TIG activArc welding.....	28
5.1.8	TIG antistick.....	28
5.1.9	Welding torch (operating variants)	28
5.1.9.1	Tapping function (tap torch trigger).....	28
5.1.9.2	Torch mode setting	29
5.1.9.3	Up/down speed	29
5.1.9.4	Current jump	29
5.1.9.5	Standard TIG torch (5-pole)	30
5.1.9.6	TIG up/down torch (8-pole)	32
5.1.9.7	Potentiometer torch (8-pole)	34
5.1.9.8	Configuring the TIG potentiometer torch connection	35
5.1.10	RTF 1 foot-operated remote control.....	36
5.1.10.1	RTF start ramp	36
5.1.10.2	RTF response	37

5.1.11	Expert menu (TIG)	38
5.1.12	Aligning the cable resistance	39
5.2	MMA welding	40
5.2.1	Welding task selection	40
5.2.2	Hotstart	41
5.2.3	Arcforce	41
5.2.4	Antistick	41
5.2.5	Average value pulse welding	42
5.2.6	Expert menu (MMA)	43
5.3	Power-saving mode (Standby)	44
5.4	Access control	44
5.5	Voltage reducing device	44
5.6	Machine configuration menu	45
5.6.1	Selecting, changing and saving parameters	45
6	Rectifying faults	49
6.1	Warnings	49
6.2	Error messages	50
6.3	Resetting welding parameters to the factory settings	51
6.4	Display machine control software version	51
7	Appendix	52
7.1	Parameter overview – setting ranges	52
7.1.1	TIG welding	52
7.1.2	MMA welding	53
7.2	Searching for a dealer	54

2 For your safety

2.1 Notes on using these operating instructions

DANGER

Working or operating procedures which must be closely observed to prevent imminent serious and even fatal injuries.

- Safety notes include the "DANGER" keyword in the heading with a general warning symbol.
- The hazard is also highlighted using a symbol on the edge of the page.

WARNING

Working or operating procedures which must be closely observed to prevent serious and even fatal injuries.

- Safety notes include the "WARNING" keyword in the heading with a general warning symbol.
- The hazard is also highlighted using a symbol in the page margin.

CAUTION

Working or operating procedures which must be closely observed to prevent possible minor personal injury.

- The safety information includes the "CAUTION" keyword in its heading with a general warning symbol.
- The risk is explained using a symbol on the edge of the page.







Technical aspects which the user must observe to avoid material or equipment damage.

Instructions and lists detailing step-by-step actions for given situations can be recognised via bullet points, e.g.:

- Insert the welding current lead socket into the relevant socket and lock.

2.2 Explanation of icons

Symbol	Description	Symbol	Description
	Indicates technical aspects which the user must observe.		Activate and release / Tap / Tip
	Switch off machine		Release
	Switch on machine		Press and hold
			Switch
	Incorrect / Invalid		Turn
	Correct / Valid		Numerical value – adjustable
	Input		Signal light lights up in green
	Navigation		Signal light flashes green

Symbol	Description	Symbol	Description
	Output		Signal light lights up in red
	Time representation (e.g.: wait 4 s / actuate)		Signal light flashes red
	Interruption in the menu display (other setting options possible)		
	Tool not required/do not use		
	Tool required/use		

2.3 Part of the complete documentation

This document is part of the complete documentation and valid only in combination with all other parts of these instructions! Read and observe the operating instructions for all system components, especially the safety instructions!

The illustration shows a general example of a welding system.

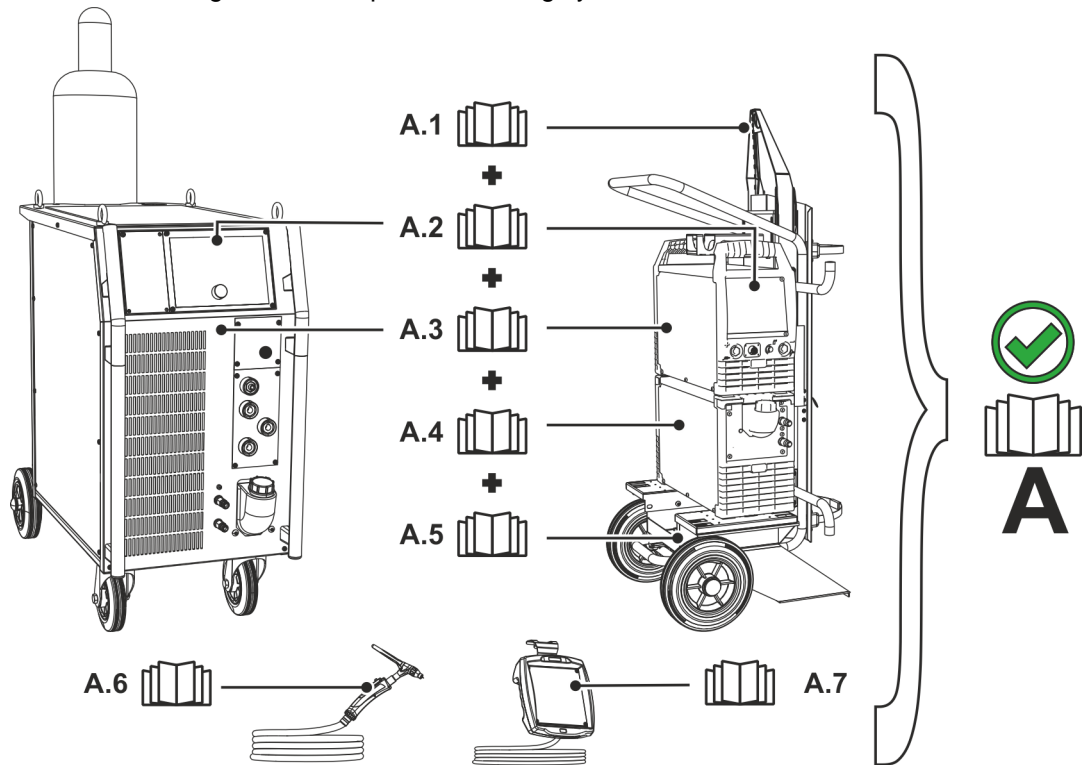

Figure 2-1

Item	Documentation
A.1	Options conversion instructions
A.2	Control
A.3	Power source
A.4	Cooling unit, voltage converter, tool box etc.
A.5	Transport cart
A.6	Welding torch
A.7	Remote control
A	Complete documentation

3 Intended use

WARNING



Hazards due to improper usage!

The machine has been constructed to the state of the art and any regulations and standards applicable for use in industry and trade. It may only be used for the welding procedures indicated at the rating plate. Hazards may arise for persons, animals and material objects if the equipment is not used correctly. No liability is accepted for any damages arising from improper usage!

- The equipment must only be used in line with its designated purpose and by trained or expert personnel!
- Do not improperly modify or convert the equipment!

3.1 Use and operation solely with the following machines

- Tetrax 300 AC/DC Smart 2.0 (T4.04)
- Tetrax 351-551 AC/DC Smart 2.0 (T4.10)

3.2 Documents which also apply

- Operating instructions for the connected welding machines
- Documents of the optional expansions

3.3 Software version

These instructions apply to the following software version:

07.03F0

The software version of the machine control can be displayed in the machine configuration menu (menu Srv) > see 5.6 chapter.

4 Machine control – Operating elements

4.1 Overview of control sections

For description purposes, the machine control has been divided into two sections (A, B) to ensure maximum clarity. The setting ranges for the parameter values are summarised in the parameter overview section > see 7.1 chapter.

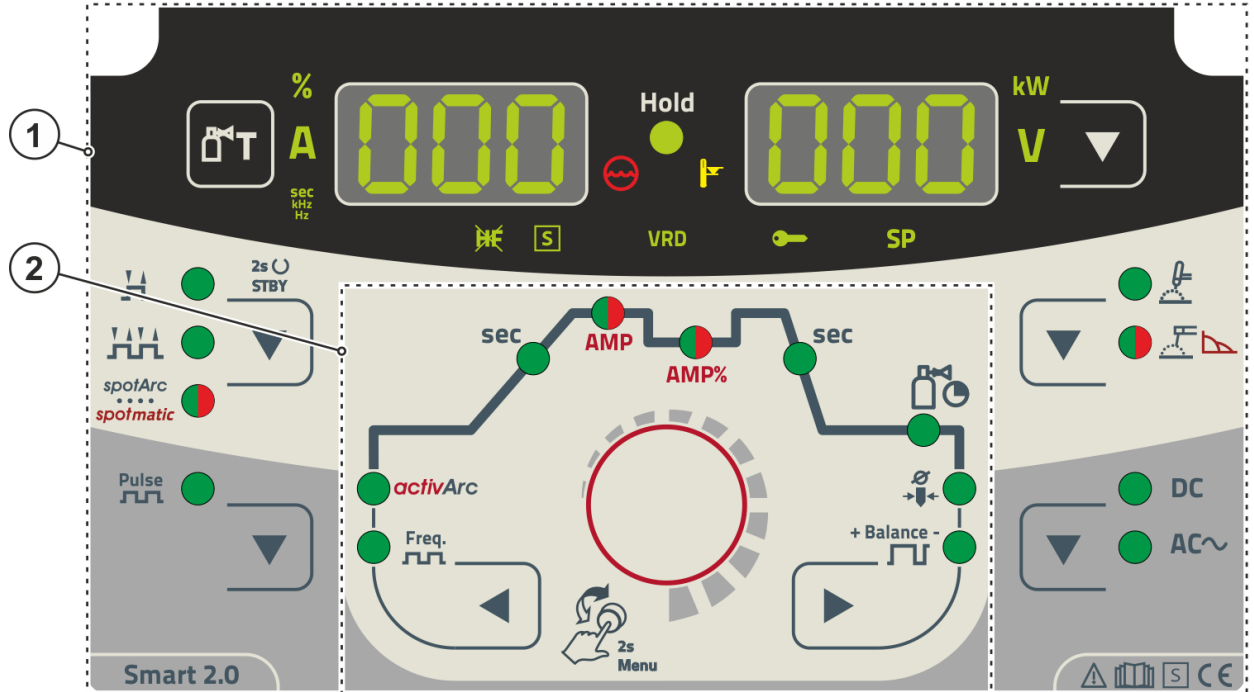

Figure 4-1

Item	Symbol	Description
1		Control section A > see 4.1.1 chapter
2		Control section B > see 4.1.2 chapter

4.1.1 Control section A

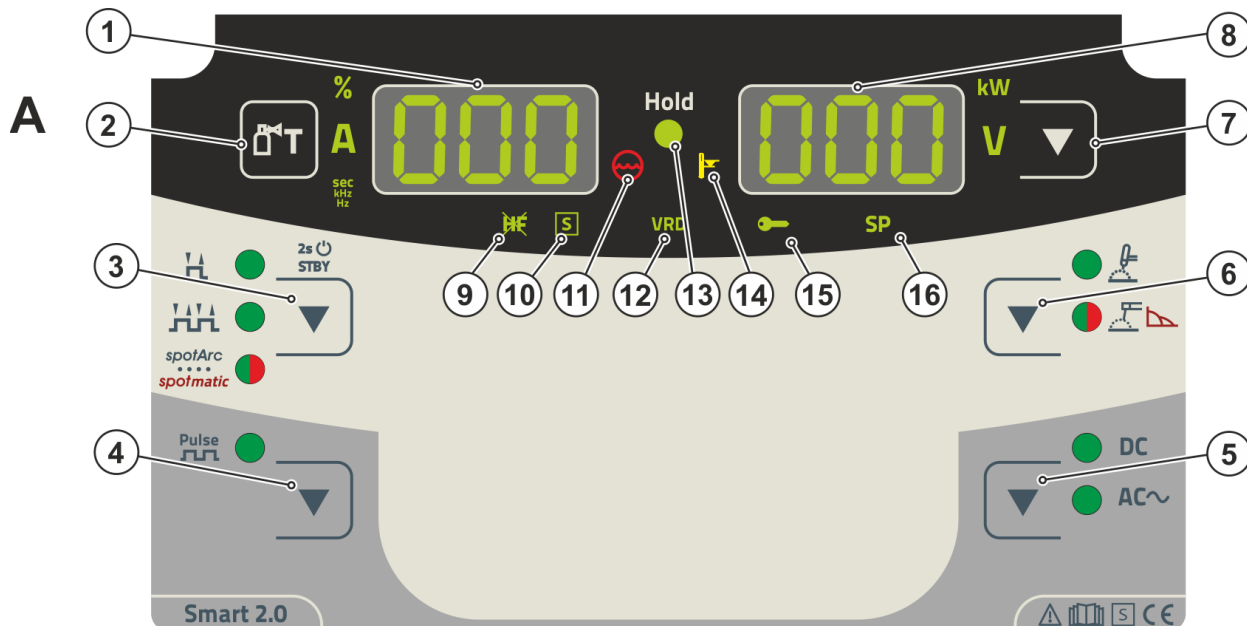
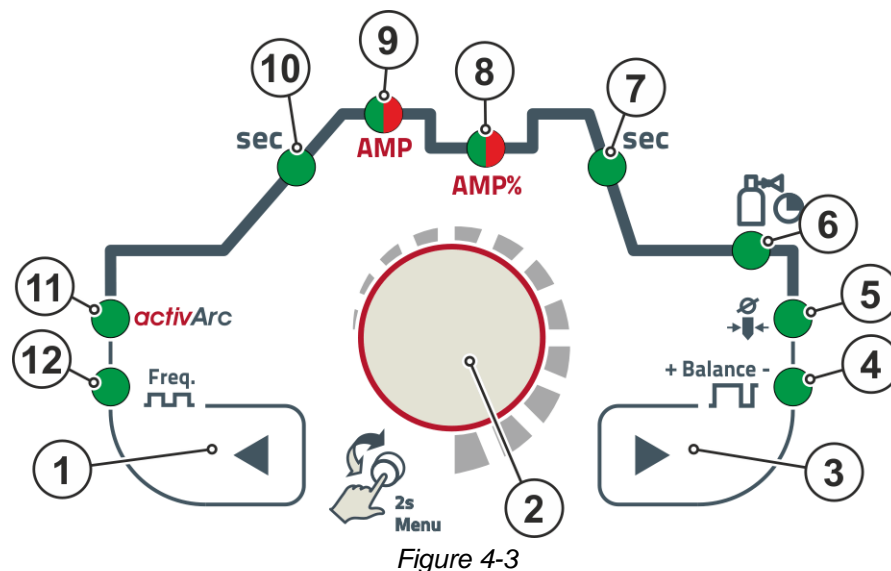

Figure 4-2



Item	Symbol	Description
1		Welding data display (3-digit) Displays the welding parameters and the corresponding values > see 4.2 chapter
2		Push-button gas test / rinse hose package > see 5.1.1 chapter
3		Operating mode > see 5.1.5 chapter / power-saving mode push-button > see 5.3 chapter H ----- Latched HH ----- Non-latched spotArc ----- spotArc spot welding procedure – signal light turns green spotmatic ----- spotmatic spot welding procedure –signal light turns red 2s STBY ----- Press button for long interval to put machine into power-saving mode. Activate one of the operating elements to reactivate.
4		Pulsed welding push-button TIG ----- pulsed welding > see 5.1.6 chapter MMA ----- pulsed welding > see 5.2.5 chapter
5		Welding current polarity push-button DC ----- DC welding with negative polarity at the torch (or electrode holder) with respect to the workpiece. AC ~ -- Alternating current welding/alternating current forms > see 5.1.3.3 chapter
6		Welding procedure push-button TIG ----- TIG welding MMA ----- MMA welding (signal light turns green) Arcforce ----- Arcforce setting (signal light turns red)
7		Display switching push-button kW ----- Welding power display V ----- Welding voltage display
8		Welding data display (3-digit) Displays the welding parameters and the corresponding values > see 4.2 chapter
9		TIG ignition type signal light Signal light on: Lift arc ignition active/HF start off. You can switch the ignition type in the Expert menu (TIG) > see 5.1.11 chapter.

Item	Symbol	Description
10		Character \square function signal light Indicates that it is possible to weld in an environment with major electric hazards, such as in boilers. Service must be informed if this signal light is not on.
11		Coolant fault signal light Signals pressure loss or low coolant level in the coolant circuit.
12	VRD	Voltage reduction device (VRD) signal light > see 5.5 chapter
13	Hold	Signal light Status display After each completed welding task, the last values used in the welding process for the welding current and welding voltage are shown on the displays, and the signal light will be on
14		Excess temperature signal light In case of excess temperature, temperature monitors de-activate the power unit, and the excess temperature control lamp comes on. Once the machine has cooled down, welding can continue without any further measures.
15		Access control active signal light Signal light is on when access control is active on the machine control > see 5.4 chapter.
16		Without function in this machine version.

4.1.2 Control section B



Item	Symbol	Description
1		Parameter selection push-button, left The welding sequence parameters are selected one after another in an anti-clockwise direction. For control systems without this button settings are done exclusively via the control button.
2		Control button Central control button to be pressed or turned > see 4.3 chapter.
3		Parameter selection push-button, right The welding sequence parameters are selected one after another in a clockwise direction. For control systems without this button settings are done exclusively via the control button.
4		Balance signal light \square Pulse balance
5		Electrode diameter signal light \square Ignition optimisation (TIG)/tungsten balling basic setting

Item	Symbol	Description
6		Gas post-flow time \overline{GPF}
7	sec	Down-slope time \overline{Edn} signal light
8	AMP% sec	Signal light, two colour Red: Secondary or pulse pause current $\overline{I_{2}}$ (% of AMP) Green: Pulse pause time $\overline{t_{2}}$ /slope time $\overline{t_{S2}}$ (Expert menu)
9	AMP sec	Signal light, two colour Red: Main \overline{I} or pulse current $\overline{I_{PL}}$ Green: Pulse time $\overline{t_{1}}$ /slope time $\overline{t_{S1}}$ (AMP to AMP%, Expert menu)
10	sec	Signal light Up-slope time $\overline{t_{UP}}$ (TIG)
11	<i>activArc</i>	Signal light activArc \overline{RR} > see 5.1.7 chapter
12	Freq. 	\overline{FrE} signal light

4.2 Machine display

The following welding parameters can be displayed before (nominal values), during (actual values) or after welding (hold values):

"left display"			
Parameter	Before welding (nominal values)	During welding (actual values)	After welding (hold values)
Welding current	<input checked="" type="checkbox"/>	<input checked="" type="checkbox"/>	<input checked="" type="checkbox"/>
Parameter times	<input checked="" type="checkbox"/>	<input type="checkbox"/>	<input type="checkbox"/>
Parameter currents	<input checked="" type="checkbox"/>	<input type="checkbox"/>	<input type="checkbox"/>
Frequency, balance	<input checked="" type="checkbox"/>	<input type="checkbox"/>	<input type="checkbox"/>
"right display"			
Welding power	<input type="checkbox"/>	<input checked="" type="checkbox"/>	<input checked="" type="checkbox"/>
Welding voltage	<input checked="" type="checkbox"/>	<input checked="" type="checkbox"/>	<input checked="" type="checkbox"/>

When the hold values are displayed after welding and the settings are then changed (e.g. welding current), the display will switch to the relevant nominal values.

possible

not possible

The parameters that can be set in the function sequence of the machine control depend on the selected welding task. This means that if for example you have not selected a pulse variant, then you cannot set any pulse times in the function sequence.

4.2.1 Setting the welding current (absolute/percentage)

The welding current for the ignition, secondary, end and hot start current can be set as a percentage of the main current AMP or as an absolute value. To select, use the parameter \overline{RbS} in the configuration menu_ref_source_inline>Gerätekonfigurationsmenü</dg_ref_source_inline>.

> see 5.6 chapter

4.3 Operating the machine control

4.3.1 Main screen

The machine control switches to the main screen after it has been turned on or a setting has been completed. This means that the previously selected settings (indicated by signal lights where applicable) and the nominal value for the current (A) are displayed in the left-hand welding data display. Depending on the selection, the right-hand display shows the welding voltage (V) nominal value or the welding power (kW) actual value. The control always switches back to the main screen after 4 sec..

4.3.2 Welding power setting

The welding power is set using the control button. You can also adjust the parameters in the operation sequence or settings in the different machine menus.

4.3.3 Welding parameter setting in the operation sequence

Welding parameters are set by briefly pressing the control knob (selecting the function sequence) and then turning the knob (navigation to the desired parameter). Press again to apply the selected parameter as the setting (corresponding parameter value and signal light flash). Turn the button to set the parameter value.

During welding parameter setting, the parameter value to be set flashes in the left hand display. A parameter abbreviation or a deviation in the specified parameter value upwards or downwards is shown on the right-hand display:

Display	Meaning
	Increase the parameter value To return to the factory settings.
	Factory setting (example value = 20) Parameter is set to optimum value
	Decrease the parameter value To return to the factory settings.

4.3.4 Setting advanced welding parameters (Expert menu)

The Expert menu contains functions and parameters which cannot be set directly in the machine control or which do not need to be set on a regular basis. The number and display of these parameters depends on the previously selected welding procedure or the functions.

To select them hold the control button for more than 2 sec. Select the required parameter/menu item by turning (navigate) and pressing (confirm) the control button.

You can also or alternatively use the push-buttons to the left and right of the control button to navigate.

4.3.5 Changing basic settings (machine configuration menu)

The basic welding system functions can be adjusted in the machine configuration menu. Only experienced users should change the settings > see 5.6 chapter.

5 Functional characteristics

5.1 TIG welding

5.1.1 Setting the shielding gas volume (gas test)/rinse hose package

- Slowly open the gas cylinder valve.
- Open the pressure regulator.
- Switch on the power source at the main switch.
- Set the relevant gas quantity for the application on the pressure regulator.
- The gas test can be activated at the machine control by pressing the "Gas test/purge"  push-button > see 4.1.1 chapter.

Setting the shielding gas quantity (gas test)

- Shielding gas flows for approx. 20 seconds or until the push-button is pressed again.

Purging long hose packages (purging)

- Press push-button for about 5 s. • Shielding gas flows for approx. 5 min. or until the push-button is pressed again.

If the shielding gas setting is too low or too high, this can introduce air to the weld pool and may cause pores to form. Adjust the shielding gas quantity to suit the welding task!

Setting instructions

Welding process	Recommended shielding gas quantity
MAG welding	Wire diameter x 11.5 = l/min
MIG brazing	Wire diameter x 11.5 = l/min
MIG welding (aluminium)	Wire diameter x 13.5 = l/min (100 % argon)
TIG	Gas nozzle diameter in mm corresponds to l/min gas throughput

Helium-rich gas mixtures require a higher gas volume!

The table below can be used to correct the gas volume calculated where necessary:

Shielding gas	Factor
75% Ar/25% He	1.14
50% Ar/50% He	1.35
25% Ar/75% He	1.75
100% He	3.16



For connecting the shielding gas supply and handling the shielding gas cylinder refer to the power source operating instructions.

5.1.1.1 Automatic gas post-flow

If the function is active, the gas post-flow time is defined by the machine control unit in dependence on power output. The defined gas post-flow time can also be adjusted if required. This value is then saved for the current welding task. The automatic gas post-flow function can be activated or deactivated in the machine configuration menu > see 5.6 chapter.

5.1.2 Welding task selection

The setting of the tungsten electrode diameter has a direct influence on the machine functionality, TIG ignition behaviour and minimum current limits. The ignition energy is controlled by the set electrode diameter. Smaller electrode diameters requires less ignition current and less ignition current time than greater electrode diameters. The set value should correspond to the tungsten electrode diameter. The value can also be set to meet individual requirements, e.g. for thin panels a smaller diameter is recommended to reduce the ignition energy.

The electrode diameter setting determines the minimum current limit, which in turn affects the ignition, main and secondary current. The minimum current limits have a positive effect on the ignition behaviour and ensure a very high arc stability for each electrode diameter selected. The minimum current limit function is enabled ex works, but can be disabled with parameter \boxed{CLL} in the machine configuration menu > see 5.6 chapter.

For foot-operated remote control mode, minimum current limits are disabled by default.

The following welding task is an example of use:

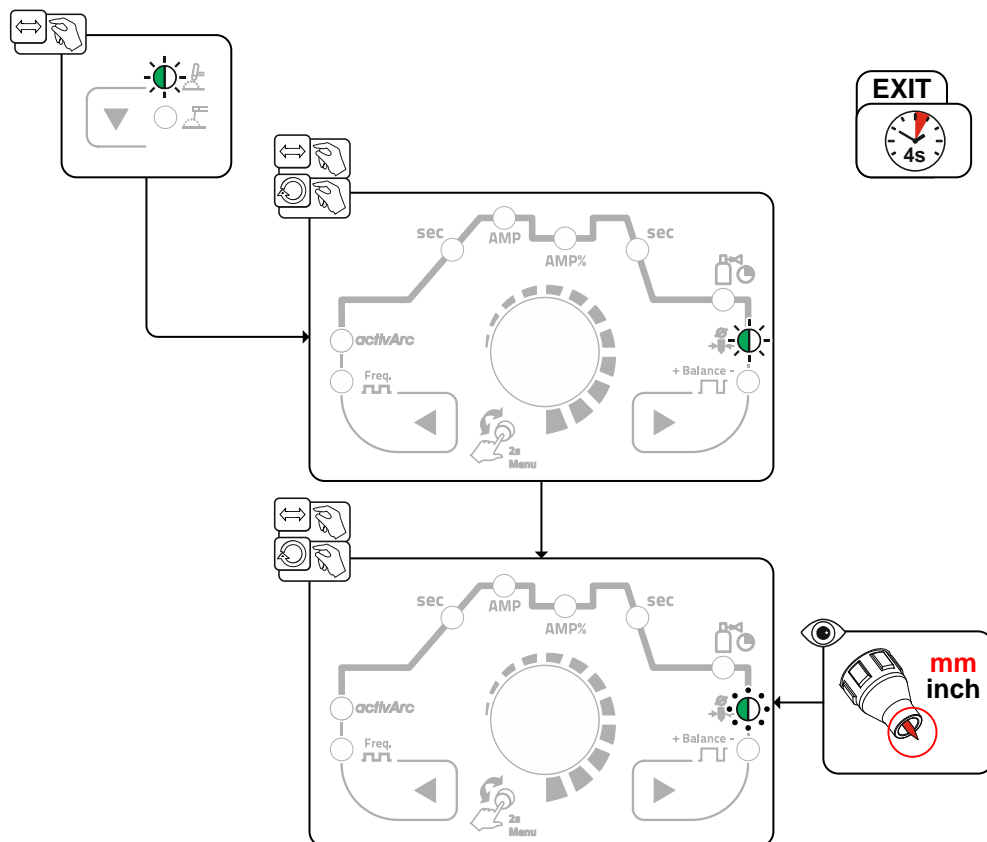

Figure 5-1

5.1.3 AC welding

5.1.3.1 AC balance (optimise cleaning effect and penetration characteristics)

To weld aluminium and aluminium alloys, AC welding is used in combination with a continuous change in polarity of the tungsten electrode. The process encompasses two phases (half-waves): a positive and a negative one. The positive phase cracks the aluminium oxide layer on the material surface (so called cleaning effect).

At the same time, tungsten balling occurs at the tip of the tungsten electrode. The size of this balled end depends on the length of the positive phase. Please note that an excessively big balled end will cause the arc to become unstable and diffuse, with low penetration. In the negative phase, the tungsten electrode is cooled and the required penetration is realised. Make sure to select the correct durations (balance) for positive phase (cleaning effect, balled end size) and negative phase (penetration depth) by setting the AC balance. The default (zero setting) balance setting is 65%, referring to the duration of the negative half-wave.

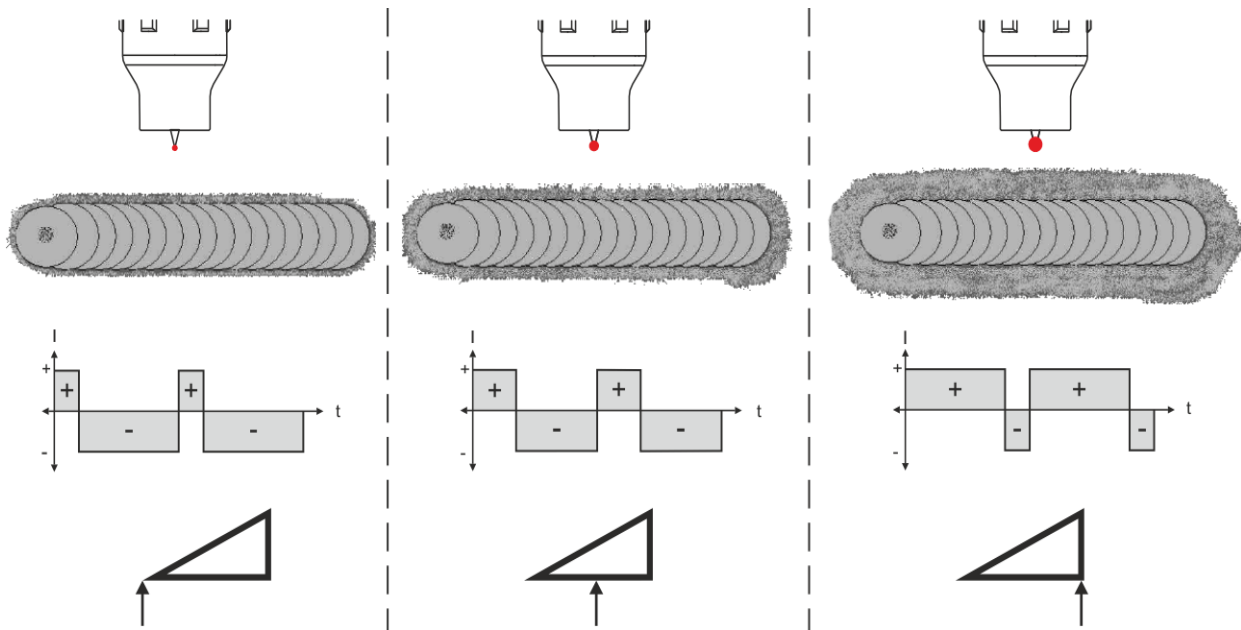

Figure 5-2

5.1.3.2 AC commutation optimisation

The AC commutation assistance function can help to increase process stability when welding materials such as pure aluminium. If half-wave failures should occur during the welding process, the parameter can be increased, counteracting half-wave failures.

The f_{CO} parameter must first be switched on in the machine configuration menu > see 5.6 chapter. The parameter value can then be selected and set in the Expert menu > see 5.1.11 chapter.

5.1.3.3 Alternating current waveforms

Selection

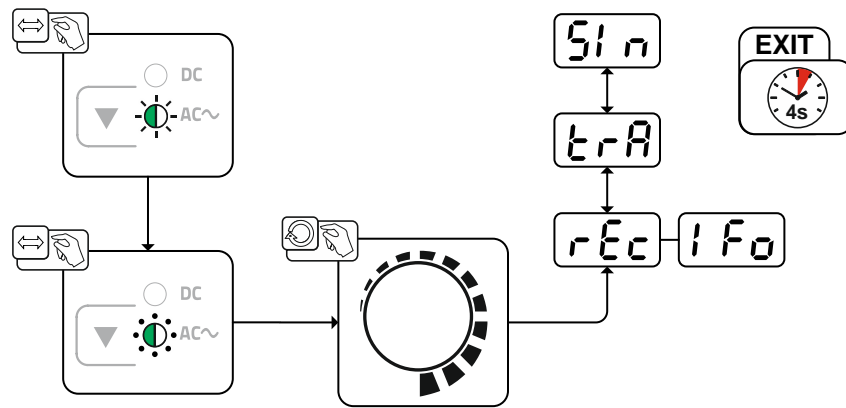

Figure 5-3

Display	Setting/selection
IFo	Alternating current waveforms ¹
	rEc -----Rectangular - Highest energy input (ex works)
	trA -----Trapezoidal - An all-rounder, suitable for most applications
	Sl n -----Sine - Low noise level

¹ for AC welding machines only.

5.1.4 Arc ignition

To change the ignition type, use parameter \overline{hF} to switch between HF start (\overline{on}) and lift arc (\overline{OFF}) in the Expert menu > see 5.1.11 chapter.

5.1.4.1 HF ignition

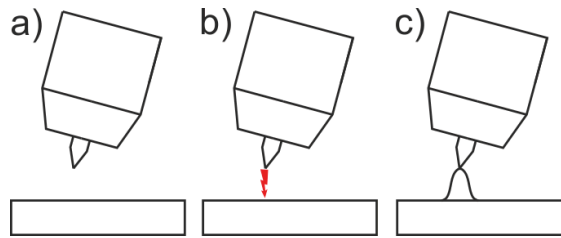

Figure 5-4

The arc is started without contact from high-voltage ignition pulses.

- Position the welding torch in welding position over the workpiece (distance between the electrode tip and workpiece should be approx. 2-3mm).
- Press the torch trigger (high voltage ignition pulses ignite the arc).
- Ignition current flows, and the welding process is continued depending on the operating mode selected.

End the welding process: Release or press the torch trigger depending on the operating mode selected.

5.1.4.2 Liftarc

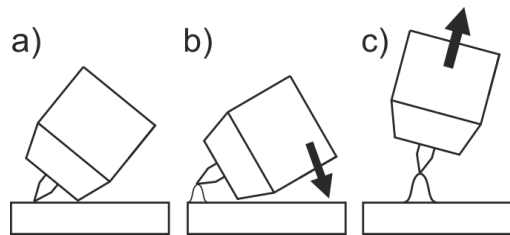

Figure 5-5

The arc is ignited on contact with the workpiece:

- Carefully place the torch gas nozzle and tungsten electrode tip onto the workpiece and press the torch trigger (liftarc current flowing, regardless of the main current set).
- Incline the torch over the torch gas nozzle to produce a gap of approx. 2-3 mm between the electrode tip and the workpiece. The arc ignites and the welding current is increased, depending on the operating mode set, to the ignition or main current set.
- Lift off the torch and swivel to the normal position.

Ending the welding process: Release or press the torch trigger depending on the operating mode selected.

5.1.4.3 Automatic cut-out

Once the fault periods have elapsed, the automatic cut-out stops the welding process when it has been triggered by one of two states:

- During ignition
5 s after the start of the welding process, no welding current flows (ignition error).
- During welding
The arc is interrupted for more than 5 s (arc interruption).



















> see 5.6 chapter

You can disable or set the time for re-ignition after an arc interruption in the machine configuration menu > see 5.6 chapter (parameter \overline{IER}).

The setting is specified separately for each welding task (JOB).

5.1.5 Operating modes (functional sequences)

5.1.5.1 Explanation of symbols

Symbol	Meaning
	Press torch trigger 1
	Release torch trigger 1
I	Current
t	Time
 GP_r	Gas pre-flow
	Ignition current
	Start time
	Up-slope time
	Spot time
 AMP	Main current (minimum to maximum current)
 AMP%	Secondary current
	Pulse current
	Pulsed TIG welding: Slope time from main current (AMP) to secondary current (AMP%)
	Pulsed TIG welding: Slope time from secondary current (AMP%) to main current (AMP%)
	Down-slope time
	End-crater current
	End-crater time
 GP_t	Gas post-flow
	Balance
	Frequency

5.1.5.2 Non-latched mode Selection

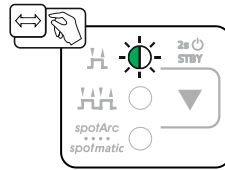

Figure 5-6

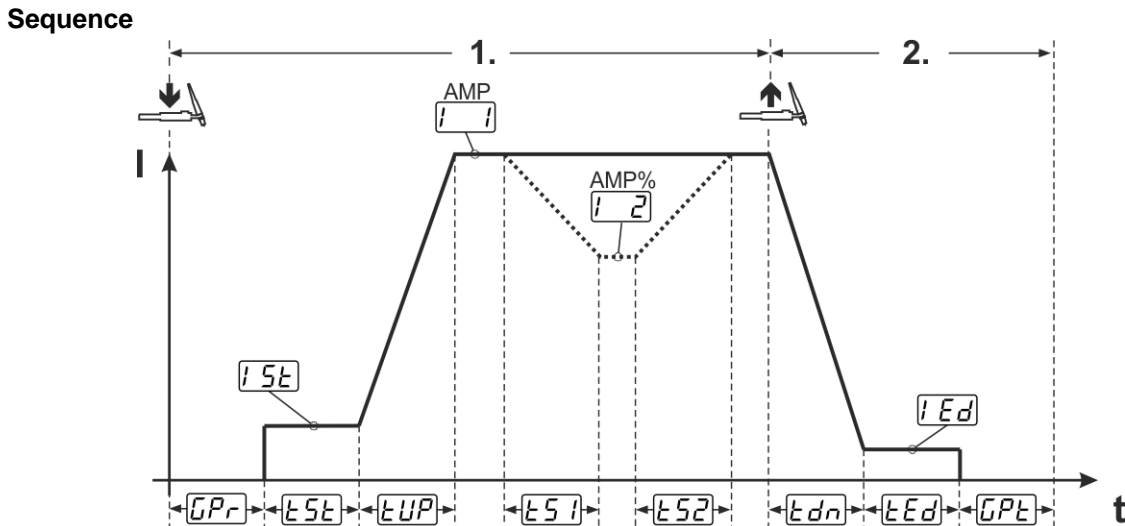

Figure 5-7

1st cycle:

- Press torch trigger 1 and hold down.
- Gas pre-flow time t_{Pr} elapses.
- HF ignition pulses jump from the electrode to the workpiece. The arc ignites.
- The welding current flows and immediately assumes the value of the ignition current i_{5t} .
- HF switches off.
- The welding current ramps up to the main current I (AMP) in the selected up-slope time t_{UP} .

If torch trigger 2 is pressed together with torch trigger 1 during the main current phase, the welding current decreases to the secondary current I_2 (AMP%) in the set slope time t_{S1} .

If torch trigger 2 is released, the welding current increases again to the main current AMP in the set slope time t_{S2} . The parameters t_{S1} and t_{S2} can be set in the Expert menu (TIG) > see 5.1.11 chapter.

2nd cycle:

- Release torch trigger 1.
- The main current falls to the end-crater current i_{Ed} (minimum current) in the set down-slope time t_{dn} .

If the 1st torch trigger is pressed during the down-slope time, the welding current returns to the set main current AMP

- Main current reaches the end-crater current i_{Ed} ; the arc is extinguished.
- Set gas post-flow time t_{Pt} elapses.

When the foot-operated remote control is connected, the machine switches automatically to non-latched operation. The up- and down-slopes are switched off.

5.1.5.3 Latched mode Selection

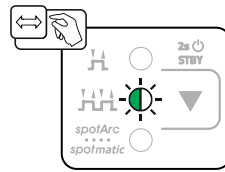

Figure 5-8

Sequence

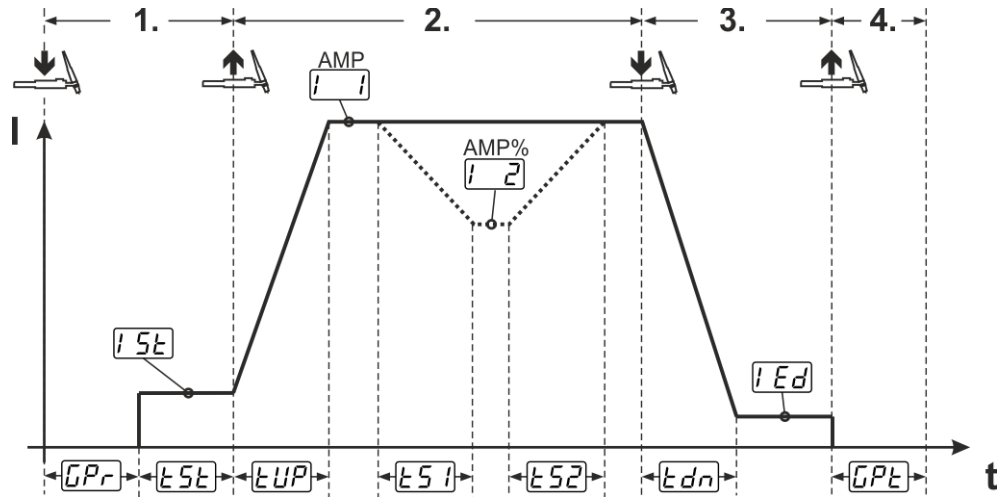

Figure 5-9

1st cycle

- Press torch trigger 1 $\langle \text{GPr} \rangle$, the gas pre-flow time elapses.
- HF start pulses jump from the electrode to the workpiece. The arc ignites.
- Welding current flows and immediately assumes the set ignition current $\langle \text{SE} \rangle$ (search arc at minimum setting). HF switches off.
- Ignition current flows at least for the start time $\langle \text{SEt} \rangle$ or as long as the torch trigger is held.

2nd cycle

- Release torch trigger 1.
- The welding current ramps up to the main current $\langle \text{I} \rangle$ (AMP) in the selected upslope time $\langle \text{UP} \rangle$.

Switching from the main current AMP to secondary current $\langle \text{I} \rangle$ (AMP%):

- Press torch trigger 2 or
- Tap torch trigger 1 (torch modes 1–6).

If torch trigger 2 is pressed together with torch trigger 1 during the main current phase, the welding current decreases to the secondary current $\langle \text{I} \rangle$ (AMP%) in the set slope time $\langle \text{SI} \rangle$.

Once torch trigger 2 is released, the welding current increases again to the main current AMP in the set slope time $\langle \text{SI} \rangle$. The parameters $\langle \text{SI} \rangle$ and $\langle \text{SI} \rangle$ can be set in the Expert menu (TIG) > see 5.1.11 chapter.

3rd cycle

- Press torch trigger 1.
- The main current decreases to the end-crater current $\langle \text{Ed} \rangle$ within the set down-slope time $\langle \text{dn} \rangle$.

Once the main current phase $\langle \text{I} \rangle$ AMP has been reached, you can shorten the welding sequence by tapping torch trigger 1 (third cycle will be omitted).

4th cycle

- Release torch trigger 1; arc is extinguished.
- Set gas post-flow time $\langle \text{PE} \rangle$ runs.

When the foot-operated remote control is connected, the machine switches automatically to non-latched operation. The up- and down-slopes are switched off.

Alternative welding start (tapping start):

For the alternative welding start, the durations of the first and second cycle are defined by the set process times only (tapping the torch trigger in the gas pre-low phase $\langle \text{GPr} \rangle$).

To activate this function, set a two-digit torch mode (11-1x) at the machine control. This function can also be deactivated completely when required (welding stop by tapping remains active). To do so, the $\langle \text{PS} \rangle$ parameter must be switched to $\langle \text{FF} \rangle$ in the machine configuration menu > see 5.6 chapter.

5.1.5.4 spotArc

This process is suitable for tack welding or joint welding of metal sheets made from steel and CrNi alloys up to a thickness of approximately 2.5 mm. Metal sheets of different thicknesses can also be welded on top of one another. As this is a one-sided process, it is also possible to weld metal sheets onto tubular sections such as round or square pipes. In arc spot welding, the arc melts through the upper metal sheet and the lower metal sheet is melted onto it. This produces flat, fine-textured welding tacks which require little or no post weld work, even in visible areas.

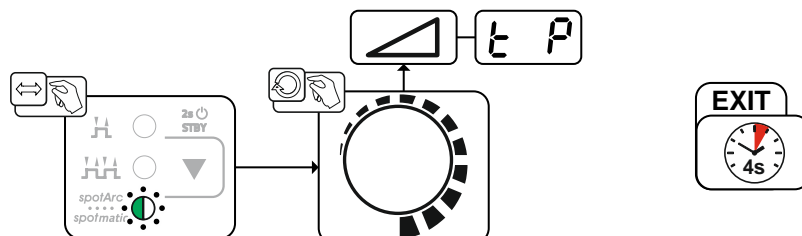

Figure 5-10

The up-slope and down-slope times should be set to "0" to achieve an effective result.

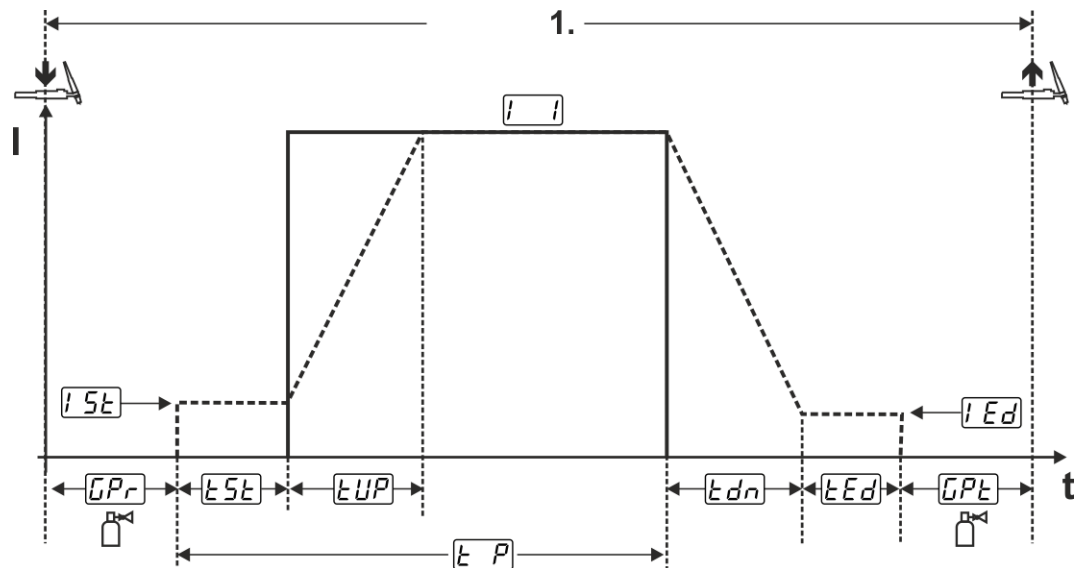

Figure 5-11

As an example the process is shown with HF ignition. Arc ignition with lift arc is also possible, however > see 5.1.4 chapter.

Sequence:

- Press torch trigger and hold down.
- The gas pre-flow time elapses.
- HF start pulses jump from the electrode to the workpiece. The arc ignites.

The welding current flows and immediately assumes the value of the ignition current i_{5t}

- HF switches off.
- The welding current ramps up to the main current i (AMP) within the set up-slope time t_{UP} .

The process ends when the set spotArc.time elapses or by releasing the torch trigger. With the spotArc function enabled, the Automatic Puls pulse variant is activated as well. If required, the function can be disabled by pressing the pulsed welding push-button.

5.1.5.5 spotmatic

In contrast to the spotArc operating mode, the arc is not ignited by pressing the torch trigger as is usual, but by briefly touching the tungsten electrode against the workpiece. The torch trigger is used for welding process activation. Activation is indicated by flashing of the spotArc/spotmatic signal light. The process can be activated separately for each spot or also on a permanent basis. The setting is controlled using the $\overline{55P}$ process activation parameter in the configuration menu > see 5.6 chapter.

- Separate process activation ($\overline{55P} > \overline{on}$):
The welding process has to be reactivated for every arc ignition by pressing the torch trigger. Process activation is automatically terminated after 30 s of inactivity.
- Permanent process activation ($\overline{55P} > \overline{off}$):
The welding process is activated by pressing the torch trigger once. The following arc ignitions are initiated by shortly touching the tungsten electrode against the workpiece. Process activation is terminated either by pressing the torch trigger again or automatically after 30 s of inactivity.

For spotmatic the separate process activation and the short spot time setting range are enabled by default.

Ignition by touching the tungsten electrode against the workpiece can be disabled in the machine configuration menu with parameter $\overline{577}$. In this case the function works as with spotArc, but the spot time setting range can be selected in the machine configuration menu.

The duration is set in the machine configuration menu using parameter $\overline{5t5}$ > see 5.6 chapter

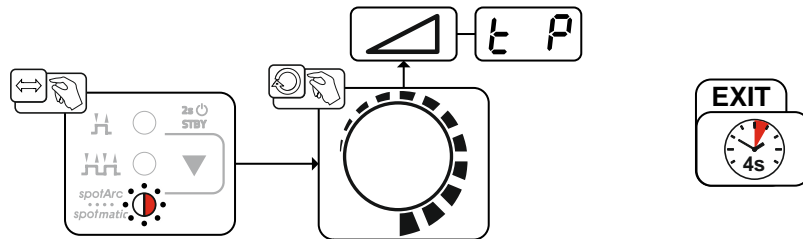

Figure 5-12

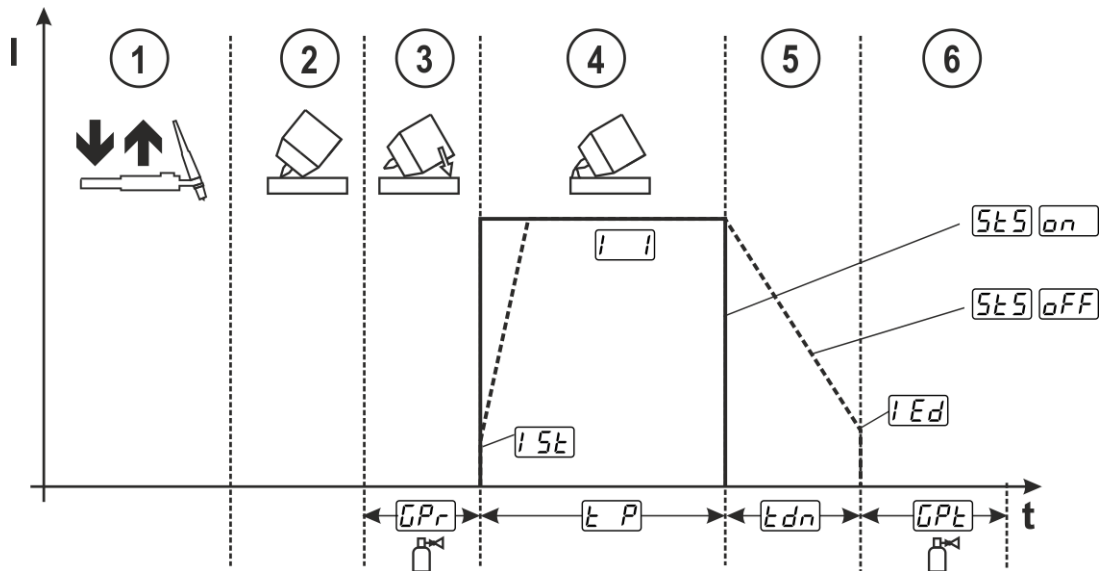

Figure 5-13

As an example the process is shown with HF ignition. Arc ignition with lift arc is also possible, however > see 5.1.4 chapter.

Selecting the process activation type for the welding process > see 5.6 chapter.

Up-slope and down-slope times possible for long spot time setting range (0.01–20.0 s) only.

- ① Press and release torch trigger (tap) to activate the welding process.
- ② Touch the torch gas nozzle and tungsten electrode tip carefully against the workpiece.
- ③ Incline the welding torch over the torch gas nozzle until there is a gap of approx. 2–3 mm between the electrode tip and the workpiece. Shielding gas flows during the set gas pre-flow time t_{GPr} . The arc ignites and the previously set ignition current i_{SE} flows.
- ④ The main current phase t_{UP} ends when the set t_{SP} spot time elapses.
- ⑤ For long-time spot welding only (parameter $t_{SES} = t_{GPF}$):
The welding current decreases to the end-crater current i_{Ed} within the set down-slope time t_{Edn} .
- ⑥ The gas post-flow time t_{GPE} elapses and the welding process ends.

Press and release the torch trigger (tap) to reactivate the welding process (only for separate process activation). Touching the welding torch with the tungsten electrode tip against the workpiece again will initiate the next welding processes.

5.1.5.6 Non-latched operation, version C

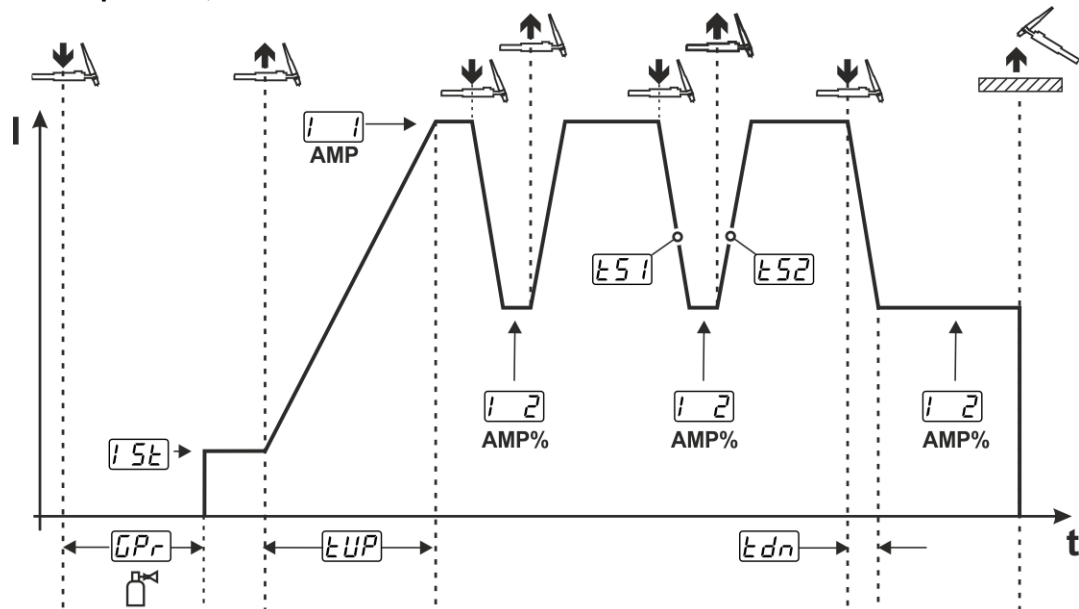

Figure 5-14

1st cycle

- Press torch trigger 1 t_{GPr} , the gas pre-flow time elapses.
- HF ignition pulses jump from the electrode to the workpiece. The arc ignites.
- Welding current flows and immediately assumes the set ignition current i_{SE} (search arc at minimum setting). HF switches off.

2nd cycle

- Release torch trigger 1.
- The welding current ramps up to the main current AMP in the selected up-slope time t_{UP} .

Pressing torch trigger 1 starts the slope t_{SE1} from main current AMP to secondary current i_2 AMP%. Releasing the torch trigger starts the slope t_{SE2} from the secondary current AMP% and back to the main current AMP. This process can be repeated as frequently as required.

The welding process is stopped by interrupting the arc in the secondary current (remove the welding torch from the workpiece until the arc is extinguished, no re-ignition).

The slope times t_{SE1} and t_{SE2} can be set in the Expert menu > see 5.1.11 chapter.

This operating mode must be enabled (parameter t_{EC}) > see 5.6 chapter.

5.1.6 Average value pulse welding

Once the pulse function is activated, the red signal lights for the main current AMP and secondary current AMP% light up at the same time. Average value pulsing means that the system switches between two currents periodically, an average current value (AMP), a pulse current (Ipuls), a balance (\overline{bRL}) and a frequency (\overline{FrE}) having been defined first. The predefined ampere current average value is decisive, the pulse current (Ipuls) is defined by the \overline{IPL} parameter as a percentage of the average current value (AMP). The pulse pause current (IPP) is not set; the machine control calculates the value instead to ensure that the average value of the welding current (AMP) is maintained. For average value pulsing, the $\overline{I2}$ current is the secondary current only, activated with the torch trigger.

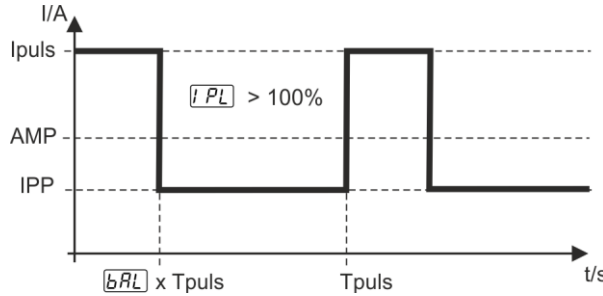

Figure 5-15

AMP = main current (average value), e.g. 100 A

Ipuls = pulse current = \overline{IPL} x AMP, e.g. 140% x 100 A = 140 A

IPP = pulse pause current

Tpuls = duration of one pulse cycle = $1/\overline{FrE}$, e.g. 1/100 Hz = 10 ms

\overline{bRL} = balance

Selection

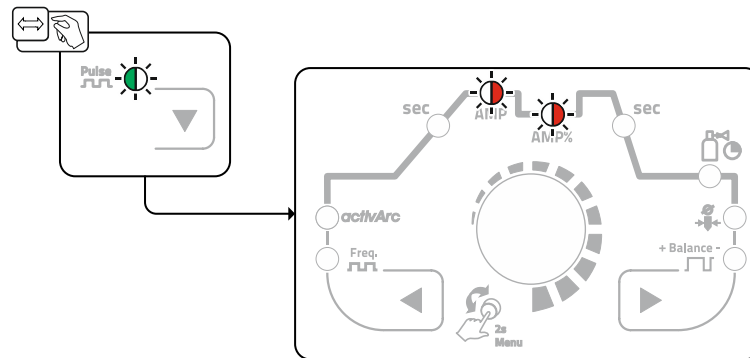

Figure 5-16

Pulse current

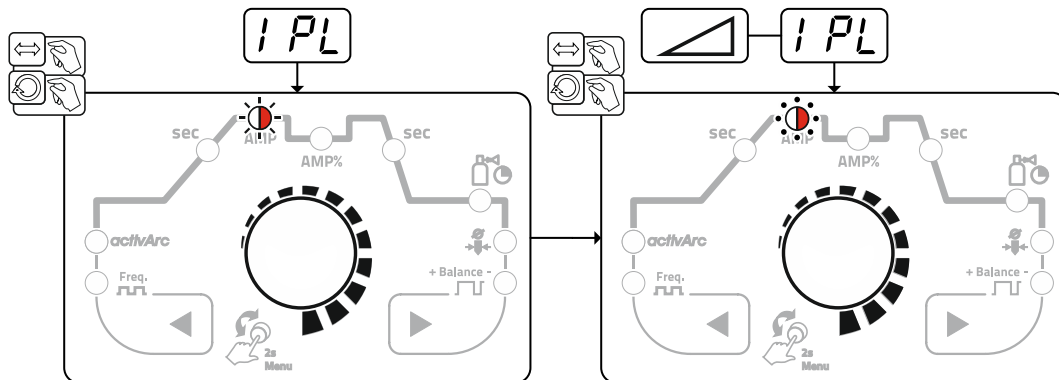

Figure 5-17

Pulse balance

Figure 5-18

Pulse frequency

Figure 5-19

5.1.6.1 Pulsed welding in the upslope and downslope phases

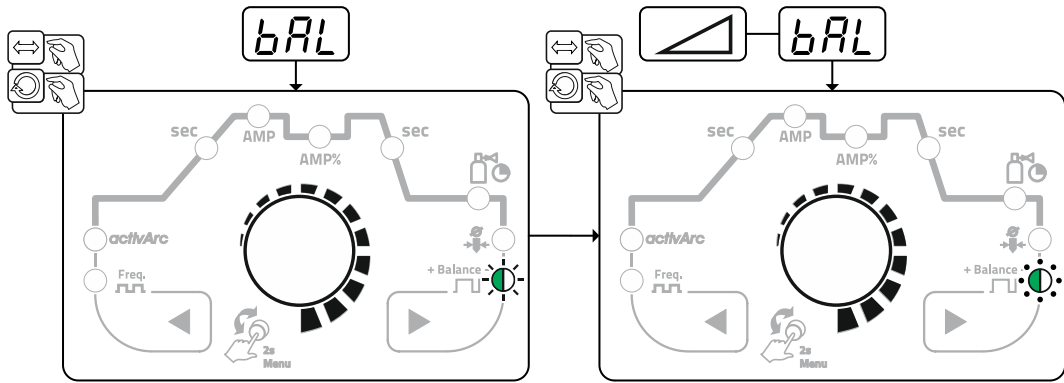
The pulse function can also be deactivated if necessary during the up-slope and down-slope phases (parameter PSL) > see 5.6 chapter.

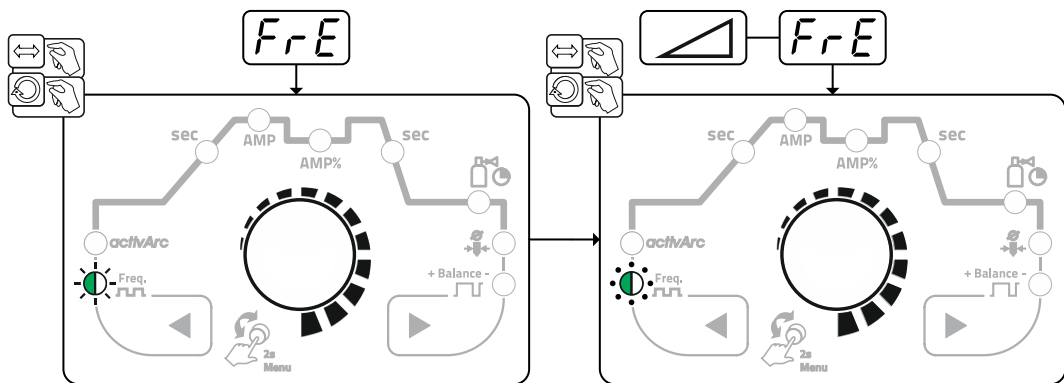
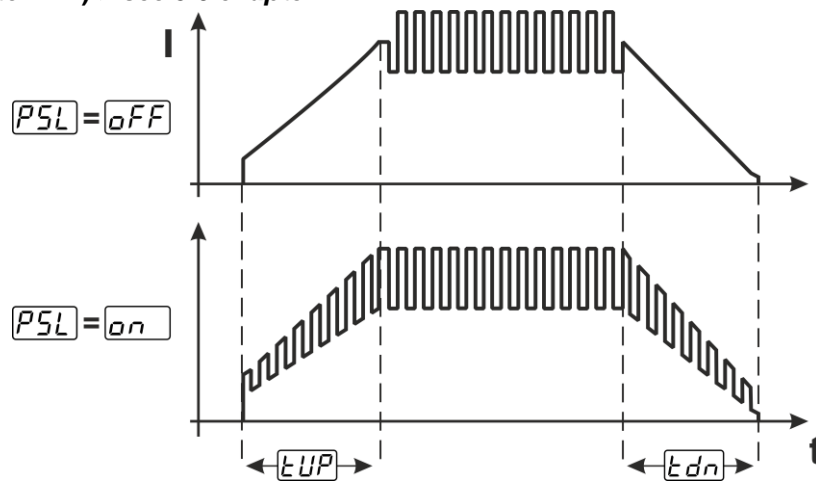

Figure 5-20

5.1.6.2 Automated pulses

The automated pulsing pulse variant is only activated for DC welding in combination with the spotArc operating mode. The current-dependent pulse frequency and balance create vibrations in the weld pool that have a positive effect on the gap bridging. The required pulse parameters are automatically defined by the machine control. If required, the function can be disabled by pressing the pulsed welding push-button.

5.1.7 TIG activArc welding

The EWM activArc process, thanks to the highly dynamic controller system, ensures that the power supplied is kept virtually constant in the event of changes in the distance between the welding torch and the weld pool, e.g. during manual welding. Voltage losses as a result of a shortening of the distance between the torch and molten pool are compensated by a current rise (ampere per volt - A/V), and vice versa. This helps prevent the tungsten electrode sticking in the molten pool and the tungsten inclusions are reduced.

Selection

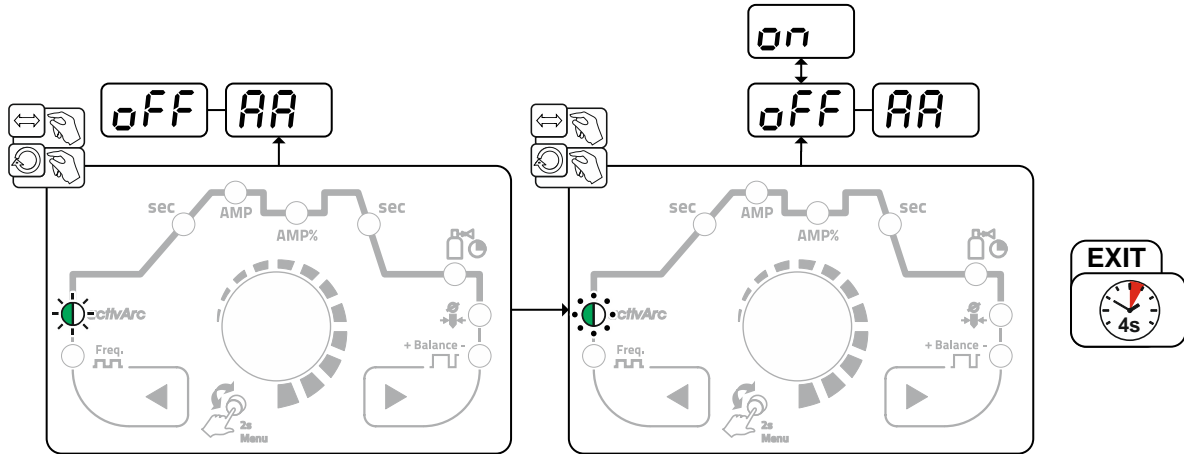

Figure 5-21

Setting

Parameter setting

The activArc parameter (control) can be adjusted specifically for the welding task (panel thickness) > see 5.1.11 chapter.

5.1.8 TIG antistick

The function prevents uncontrolled re-ignition following the sticking of the tungsten electrode in the weld pool by switching off the welding current. In addition, wear at the tungsten electrode is reduced.

After triggering the function the machine immediately switches to the gas post-flow process phase. The welder starts the new process again at the first cycle. The user can switch the function on or off (parameter [RS]) > see 5.6 chapter.

5.1.9 Welding torch (operating variants)

Different torch versions can be used with this machine.

Functions on the operating elements, such as torch triggers (BRT), rockers or potentiometers, can be modified individually via torch modes.

Explanation of symbols for operating elements:

Symbol	Description
	Press torch trigger
	Tap torch trigger
	Tap and press torch trigger

5.1.9.1 Tapping function (tap torch trigger)

Tapping function: Swiftly tap the torch trigger to change the function. The set torch mode determines the operating mode.

5.1.9.2 Torch mode setting

Modes 1 to 6 and 11 to 16 are available to the user. Modes 11 to 16 feature the same functionality as 1 to 6, but without the tapping function > see 5.1.9.1 chapter for the secondary current.

The functionality of the individual modes can be found in the corresponding torch type tables.

The torch modes are set using the torch configuration parameters " $\overline{[crd]}$ " in the machine configuration menu > torch mode " $\overline{[cod]}$ " > see 5.6 chapter.

Only the modes listed are suitable for the corresponding torch types.

5.1.9.3 Up/down speed

Functionality

Press and hold the up push-button:

Increase current up to the maximum value (main current) set in the power source.

Press and hold the down push-button:

Decrease current to the minimum value.

Use the machine configuration menu > see 5.6 chapter to set the up/down speed parameter $\overline{[uld]}$ which determines the speed with which a current change becomes effective.

5.1.9.4 Current jump

By tapping the corresponding torch trigger the welding current can be determined in an adjustable jump range. Each tap will cause the welding current to jump up or down by the defined value.

The "current jump" parameter $\overline{[dj]}$ is set in the machine configuration menu > see 5.6 chapter.

5.1.9.5 Standard TIG torch (5-pole)

Standard torch with one torch trigger

Figure	Operating elements	Explanation of symbols
		BRT1 = torch trigger 1 (welding current on/off; secondary current via tapping function)

Functions	Mode	Operating elements
Welding current on/off	1 (ex works)	
Secondary current (latched operation)		

Standard torch with two torch triggers

Figure	Operating elements	Explanation of symbols
		BRT1 = torch trigger 1 BRT2 = torch trigger 2

Functions	Mode	Operating elements
Welding current on/off	1 (ex works)	
Secondary current		
Secondary current (tapping function) ¹ /(latched operating mode)		
Welding current on/off	3	
Secondary current (tapping function) ¹ /(latched operating mode)		
Up function ²		
Down function ²		

¹ > see 5.1.9.1 chapter

² > see 5.1.9.3 chapter

Standard torch with one rocker (rocker, two torch triggers)

Figure	Operating elements	Explanation of symbols
		BRT 1 = torch trigger 1 BRT 2 = torch trigger 2

Functions	Mode	Operating elements
Welding current on/off	1 (ex works)	
Secondary current		
Secondary current (tapping function) ¹ /(latched operating mode)		
Welding current on/off	2	
Secondary current (tapping function) ¹		
Up function ²		
Down function ²		
Welding current on/off	3	
Secondary current (tapping function) ¹ /(latched operating mode)		
Up function ²		
Down function ²		

¹ > see 5.1.9.1 chapter

² > see 5.1.9.3 chapter

5.1.9.6 TIG up/down torch (8-pole)

Up/down torch with one torch trigger

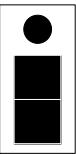
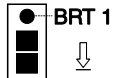
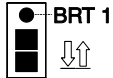
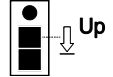
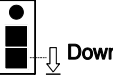
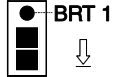
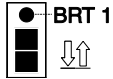
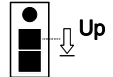
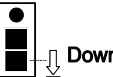

Figure	Operating elements	Explanation of symbols
		BRT 1 = torch trigger 1
Functions	Mode	Operating elements
Welding current on/off	1 (ex works)	
Secondary current (tapping function ¹)/(latched operating mode)		
Increase welding current (up function ²)		
Decrease welding current (down function ²)		
Welding current on/off	4	
Secondary current (tapping function ¹)/(latched operating mode)		
Increase welding current via current jump ³		
Decrease welding current via current jump ³		

¹ > see 5.1.9.1 chapter

² > see 5.1.9.3 chapter

³ > see 5.1.9.4 chapter

Up/down torch with two torch triggers

Figure	Operating elements	Explanation of symbols
		BRT 1 = torch trigger 1 (left) BRT 2 = torch trigger 2 (right)

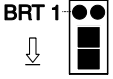
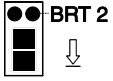
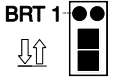
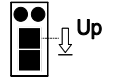
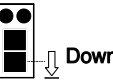
Functions	Mode	Operating elements
Welding current on/off	1 (ex works)	
Secondary current		
Secondary current (tapping function) ¹ /(latched operating mode)		
Increase welding current (up function) ²		
Decrease welding current (down function) ²		

Modes 2 and 3 are not used with this type of torch or, respectively, are not appropriate.

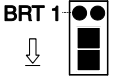
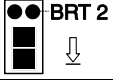
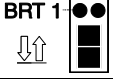
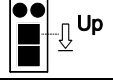
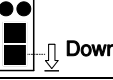
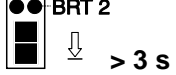
Welding current on/off	4	
Secondary current		
Secondary current (tapping function) ¹		
Increase welding current via current jump ³		
Decrease welding current via current jump ³		
Gas test		

¹ > see 5.1.9.1 chapter

² > see 5.1.9.3 chapter

³ > see 5.1.9.4 chapter

5.1.9.7 Potentiometer torch (8-pole)

The welding machine needs to be configured for operation with a potentiometer torch > see 5.1.9.8 chapter.

Potentiometer torch with one torch trigger

Figure	Operating elements	Explanation of symbols
		BRT 1 = torch trigger 1
Functions	Mode	Operating elements
Welding current on/off	3	
Secondary current (tapping function ¹)		
Increase welding current		
Decrease welding current		

Potentiometer torch with two torch triggers

Figure	Operating elements	Explanation of symbols
		BRT 1 = torch trigger 1 BRT 2 = torch trigger 2
Functions	Mode	Operating elements
Welding current on/off	3	
Secondary current		
Secondary current (tapping function ¹)		
Increase welding current		
Decrease welding current		

¹ > see 5.1.9.1 chapter

5.1.9.8 Configuring the TIG potentiometer torch connection

DANGER



Risk of injury due to electrical voltage after switching off!
Working on an open machine can lead to fatal injuries!
Capacitors are loaded with electrical voltage during operation. Voltage remains present for up to four minutes after the mains plug is removed.

1. Switch off machine.
2. Remove the mains plug.
3. Wait for at last 4 minutes until the capacitors have discharged!

WARNING



Do not carry out any unauthorised repairs or modifications!
To avoid injury and equipment damage, the unit must only be repaired or modified by specialist, skilled persons!

The warranty becomes null and void in the event of unauthorised interference.

- Appoint only skilled persons for repair work (trained service personnel)!



Dangers resulting from failure to perform test after conversion!
Before reconnection, "Inspection and Testing during Operation" according to IEC/BS EN 60974-4 "Arc welding systems – Inspection and Testing during Operation" has to be performed!

- Perform test to IEC / DIN EN 60974-4!

When connecting a potentiometer torch, jumper JP27 on PCB T320/1 inside the welding machine should be unplugged.

Welding torch configuration	Setting
Prepared for TIG standard or up/down torch (factory setting)	<input checked="" type="checkbox"/> JP27
Prepared for potentiometer torches	<input type="checkbox"/> JP27

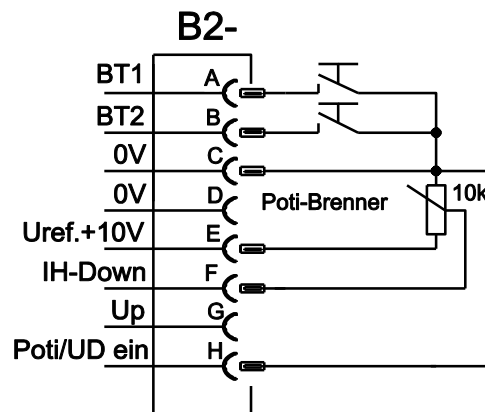

Figure 5-22

This torch type requires the welding machine to be set to torch mode 3 > see 5.1.9.2 chapter.

5.1.10 RTF 1 foot-operated remote control

5.1.10.1 RTF start ramp

The RTF start ramp function prevents the energy input at the start of welding from being too high and too fast should the user press the remote control pedal too fast and too strongly.

Example:

The user sets the main current at the welding machine to 200 A. The user presses the remote control pedal very quickly down by approx. 50% of the pedal travel.

- RTF switched on: The welding current increases in a linear (slow) ramp to approx. 100 A.
- RTF switched off: The welding current immediately jumps to approx. 100 A.

The RTF start ramp function is activated/deactivated by the parameter \overline{FFr} in the machine configuration menu > see 5.6 chapter.

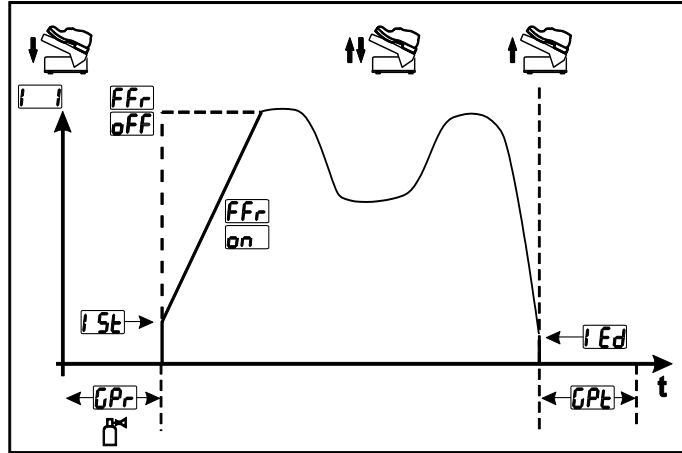

Figure 5-23

Display	Setting/selection
\overline{FFr}	RTF start ramp > see 5.1.10.1 chapter \overline{on} ----- Welding current rises to the specified main current level in a ramp function (ex works) \overline{off} ----- Welding current immediately jumps to the specified main current level
\overline{GPr}	Gas pre-flow time
\overline{ISt}	Ignition current (as percentage, dependent on main current)
\overline{IEd}	End-crater current Setting range in percent: depending on main current Setting range, absolute: Imin to Imax.
\overline{GPe}	Gas post-flow time

5.1.10.2 RTF response

This function controls the current response during the main current phase. The user can choose between linear and logarithmic response. The logarithmic setting is especially suited for welding with low currents, e.g. for thin panels, as the logarithmic response enables a better control of the welding current.

In the machine configuration menu, the RTF response function \overline{FrE} can be toggled between linear response \overline{Lin} and logarithmic response \overline{LoG} (ex works) > see 5.6 chapter.

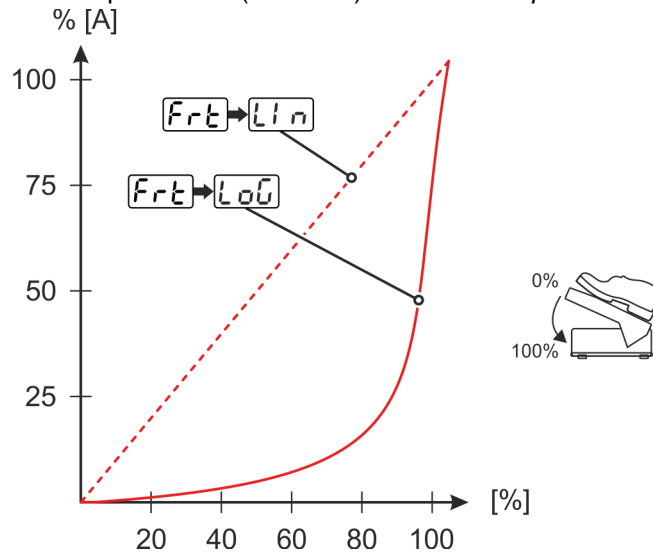

Figure 5-24

5.1.11 Expert menu (TIG)

The Expert menu has adjustable parameters stored that don't require regular setting. The number of parameters shown may be limited, e.g. if a function is deactivated.

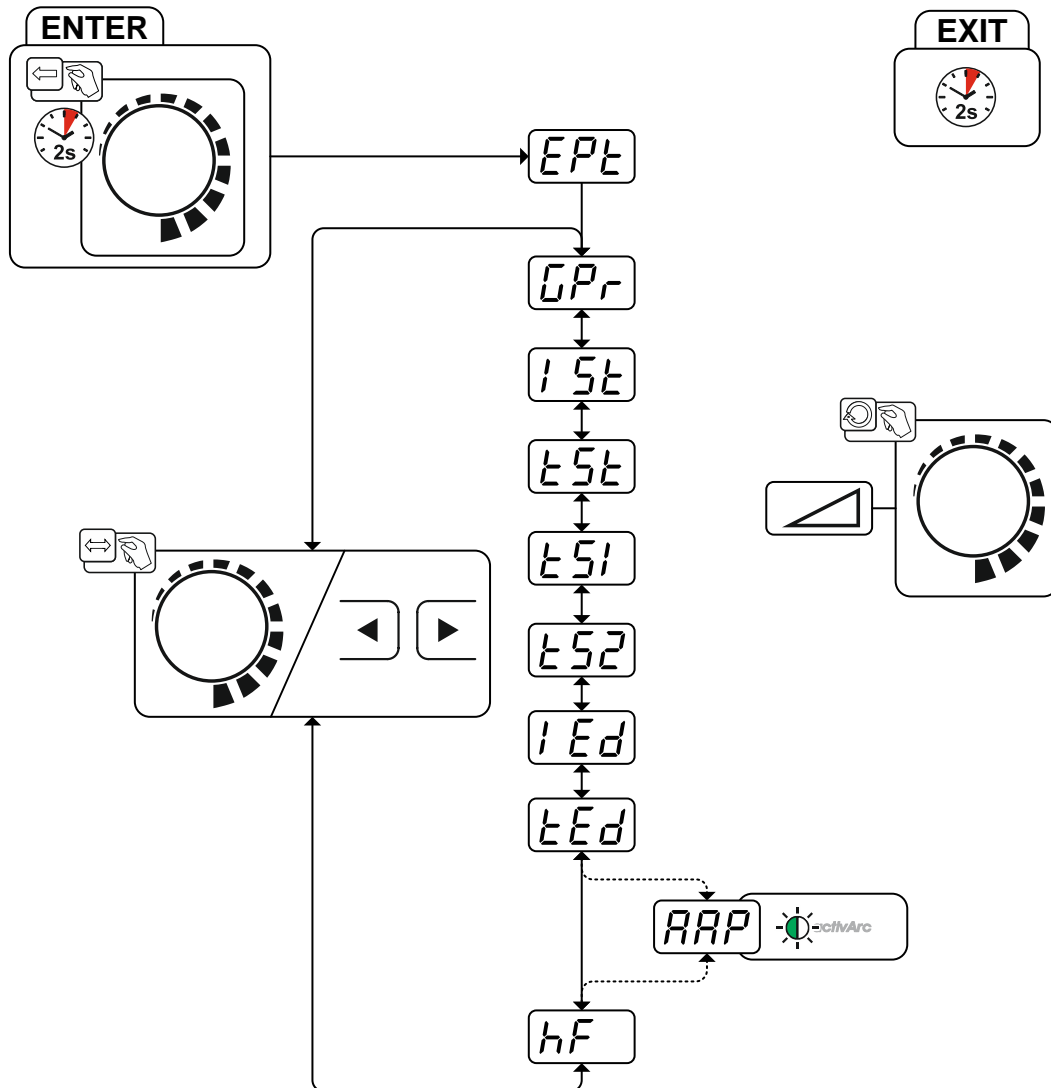

Figure 5-25

Display	Setting/selection
	Expert menu
	Gas pre-flow time
	Ignition current Setting range in percent: depending on main current Setting range, absolute: Imin to Imax.
	Slope time (main current to secondary current)
	Slope time (main current to secondary current)
	Slope time (main current to secondary current)
	End-crater current Setting range in percent: depending on main current Setting range, absolute: Imin to Imax.

Display	Setting/selection
	Slope time (main current to secondary current)
	activArc parameter Parameter also adjustable after TIG activArc welding is activated.
	Ignition type (TIG) <input type="checkbox"/> on -----HF start active (ex works) <input type="checkbox"/> off -----Lift arc ignition active

5.1.12 Aligning the cable resistance

To ensure optimum welding properties, the electric cable resistance should be aligned again whenever an accessory component such as the welding torch or the intermediate hose package (AW) has been changed. The resistance value of the cables can be set directly or can be aligned by the power source. In the delivery state the cable resistance is set to the optimum values. To optimise the welding properties for other cable lengths, an alignment process (voltage correction) is necessary.

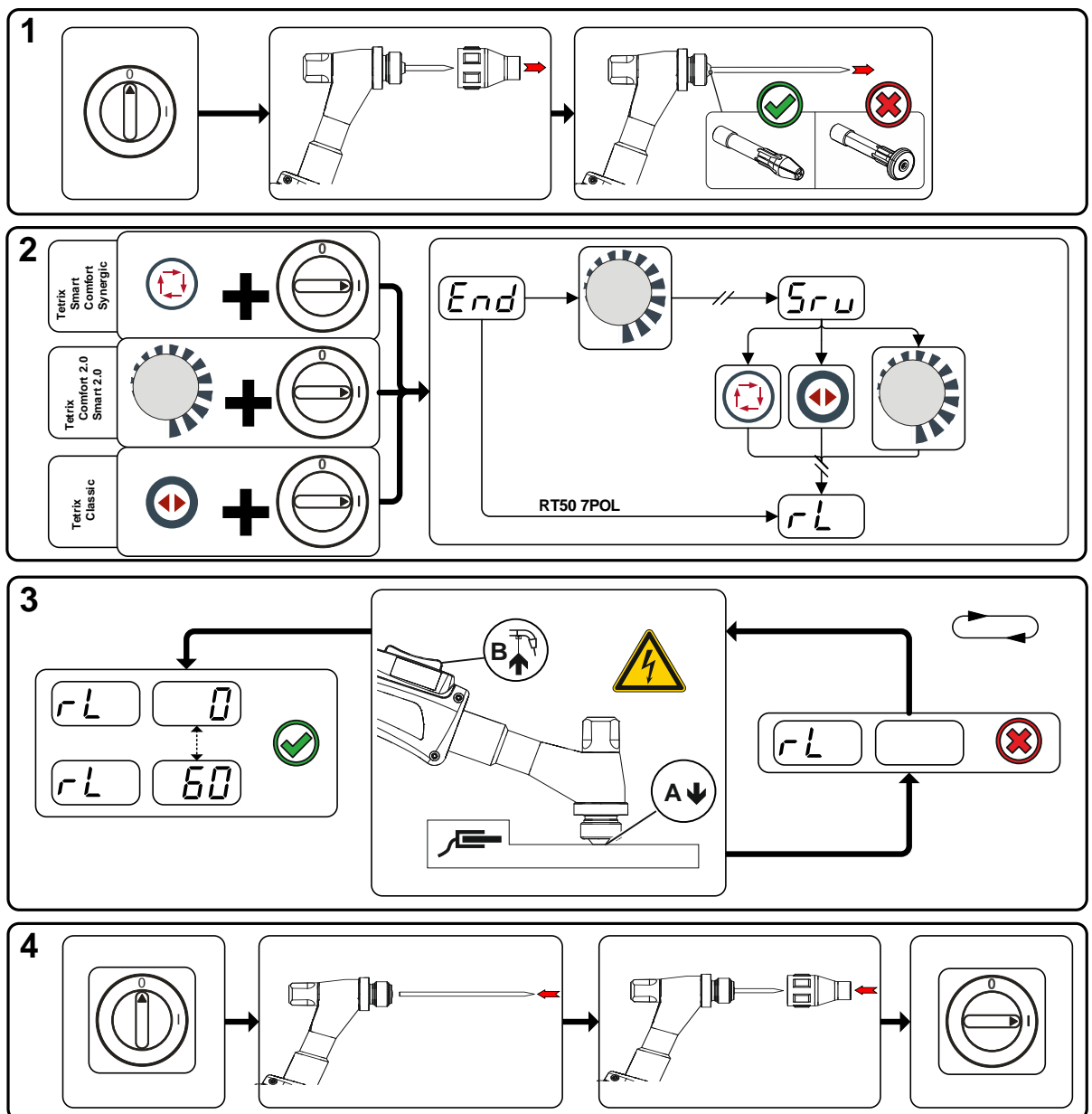





Figure 5-26

1 Preparation

- Switch off the welding machine.
- Unscrew the gas nozzle from the welding torch.
- Unfasten the tungsten electrode and extract.

2 Configuration

- Activate the  rotary knob while switching on the welding machine at the same time.
- Release rotary knob.
- You can now use the  rotary knob (rotate and press) to select the parameter  > see 5.6 chapter.

3 Alignment/measurement

- Applying slight pressure, press the welding torch with the collet against a clean, purged location on the workpiece and then press the torch trigger for approx. 2 seconds. A short-circuit current will flow briefly, which is used to determine and display the cable resistance. The value can be between 0 mΩ and 60 mΩ. The new value is immediately saved without requiring further confirmation. If no value is shown on the right-hand display, then measurement failed. The measurement must be repeated.

4 Restoring welding standby mode

- Switch off the welding machine.
- Lock the tungsten electrode in the collet again.
- Screw the gas nozzle onto the welding torch.
- Switch on the welding machine.

5.2 MMA welding

5.2.1 Welding task selection

It is only possible to change the basic parameters when no welding current is flowing and any possible access control is disabled > see 5.4 chapter.

The following welding task selection is an example of use. In general, the selection process always has the same sequence. Signal lights (LED) will show the selected combination.

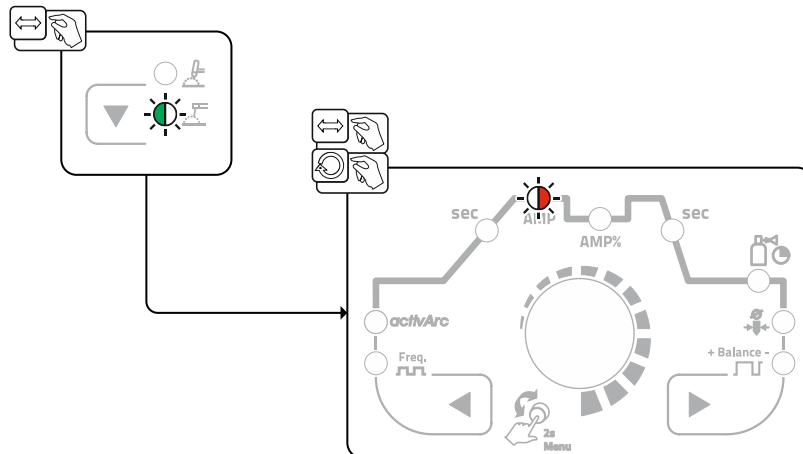

Figure 5-27

5.2.2 Hotstart

The function hot start ensures a secure igniting of the arc and a sufficient heating to the still cold parent metal at the beginning of the welding process. The ignition takes place here with increased current (hot start current) over a certain time (hot start time).

For parameter setting, > see 5.2.6 chapter.

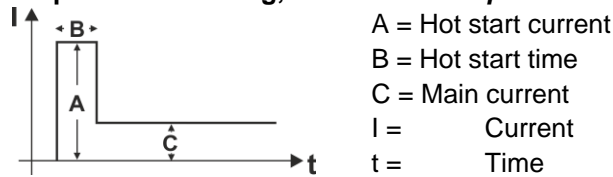

Figure 5-28

5.2.3 Arcforce

During the welding process, arcforce prevents the electrode sticking in the weld pool with increases in current. This makes it easier to weld large-drop melting electrode types at low current strengths with a short arc in particular.

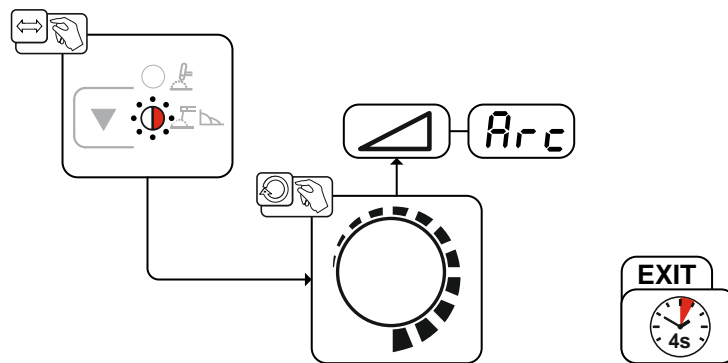
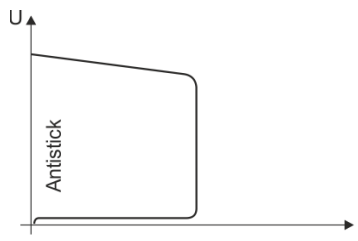

Figure 5-29

5.2.4 Antistick



The Antistick feature prevents the electrode from annealing.

Should the electrode stick despite the Arcforce feature, the machine automatically switches to the minimum current within approx. one second. This prevents the electrode from annealing. Check the welding current setting and correct for the welding task in hand.

Figure 5-30

5.2.5 Average value pulse welding

Average value pulse welding means that two currents are switched periodically, a current average value (AMP), a pulse current (I_{puls}), a balance (bRL) and a frequency (F_{rE}) having been defined first. The predefined ampere current average value is decisive, the pulse current (I_{puls}) is defined by the iPL parameter as a percentage of the current average value (AMP). The pulse pause current (IPP) requires no setting. This value is calculated by the machine control, so that the welding current average value (AMP) is maintained at all times.

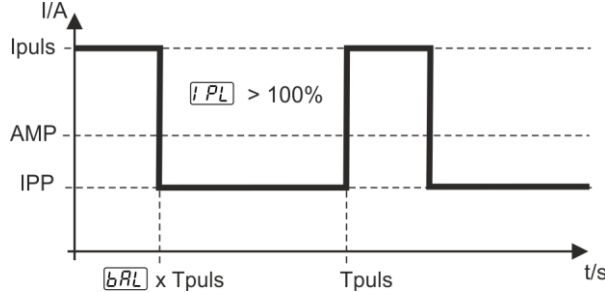

Figure 5-31

AMP = Main current; e.g. 100 A

I_{puls} = Pulse current = $iPL \times AMP$; e.g. 140% x 100 A = 140 A

IPP = Pulse pause current

T_{puls} = Duration of one pulse cycle = $1/F_{rE}$; e.g. 1/1 Hz = 1 s

bRL = Balance

Selection

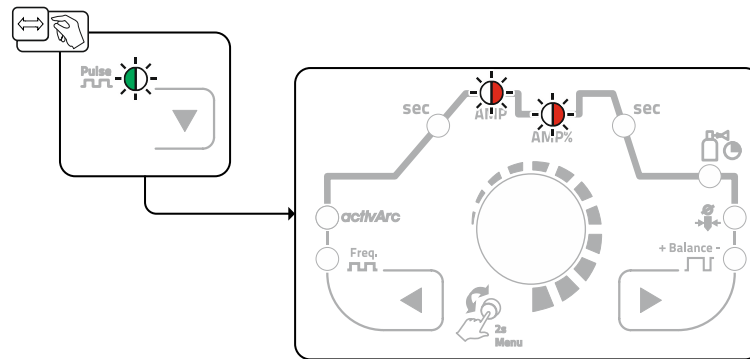

Figure 5-32

Pulse current

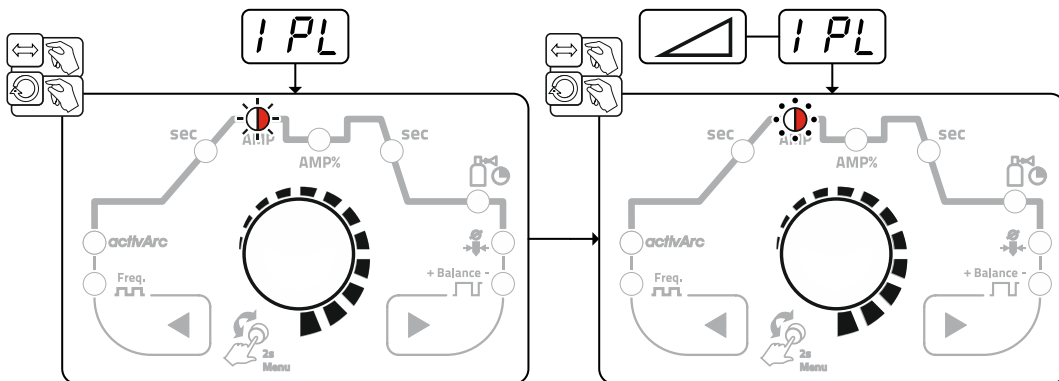

Figure 5-33

Pulse balance

Figure 5-34

Pulse frequency

Figure 5-35

5.2.6 Expert menu (MMA)

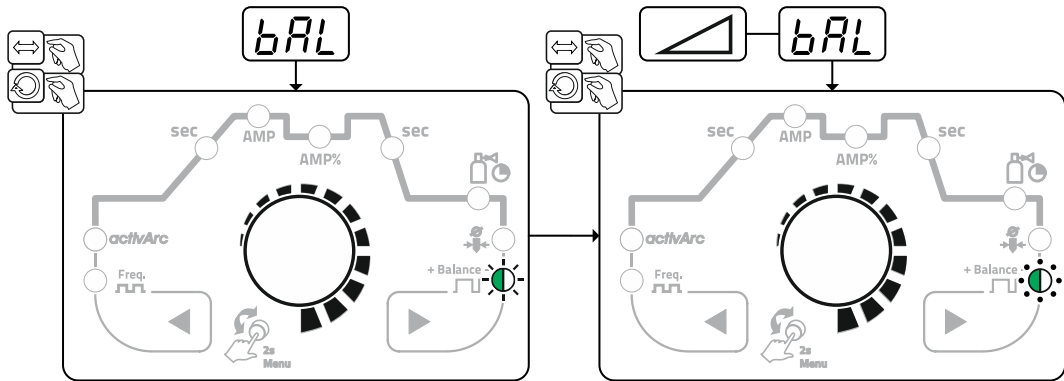
The Expert menu has adjustable parameters stored that don't require regular setting. The number of parameters shown may be limited, e.g. if a function is deactivated.

The setting ranges for the parameter values are summarised in the Parameter overview section > see 7.1 chapter.

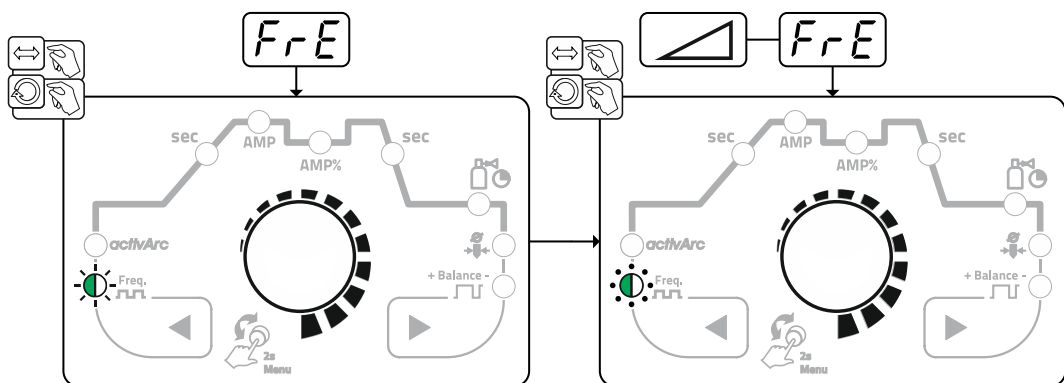
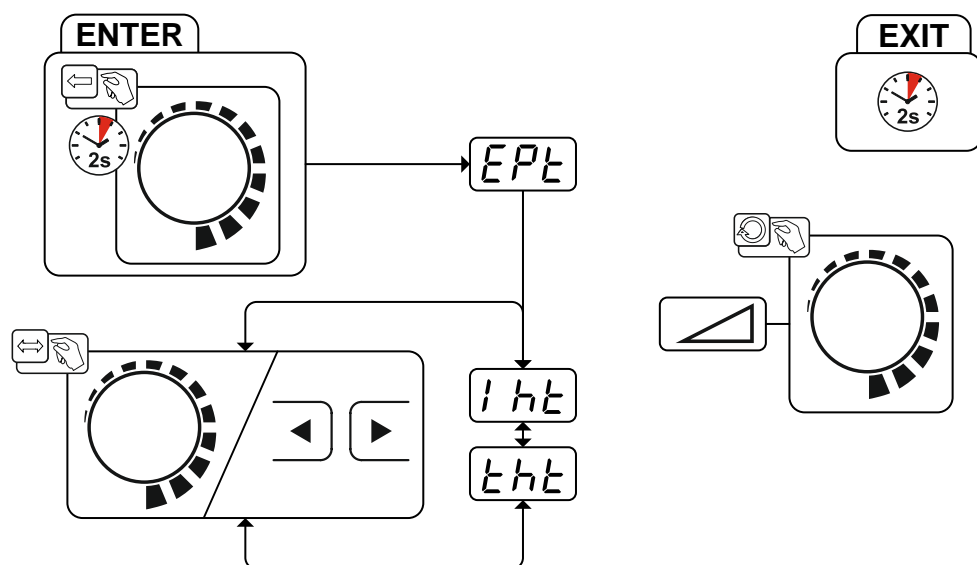
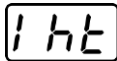
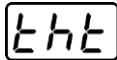

Figure 5-36

Display	Setting/selection
	Expert menu

Display	Setting/selection
	Hotstart current
	Hotstart time

5.3 Power-saving mode (Standby)

You can activate the power-saving mode by either pressing the push-button > see 4 chapter for a prolonged time or by setting a parameter in the machine configuration menu (time-controlled power-saving mode $\overline{5bA}$) > see 5.6 chapter.



When power-saving mode is activated, the machine displays show the horizontal digit in the centre of the display only.

Pressing any operating element (e.g. turning a rotary knob) deactivates power-saving mode and the machine is ready for welding again.

5.4 Access control

The machine control can be locked to secure it against unauthorised or unintentional adjustment. The access block has the following effect:

- The parameters and their settings in the machine configuration menu, Expert menu and operation sequence can only be viewed but not changed.
- Welding procedure and welding current polarity cannot be changed.

The parameters for setting the access block are configured in the machine configuration menu > see 5.6 chapter.

Enabling access block

- Assign the access code for the access block: Select parameter \overline{cod} and select a number code (0–999).
- Enable access block: Set parameter \overline{loc} to access block enabled \overline{on} .

The access block activation is indicated by the "Access block active" signal light > see 4 chapter.

Disabling access block

- Enter the access code for the access block: Select parameter \overline{cod} and enter the previously selected number code (0–999).
- Disable access block: Set parameter \overline{loc} to access block disabled \overline{off} . The only way to disable the access block is to enter the selected number code.

5.5 Voltage reducing device

Only machine variants with the (VRD/SVRD/AUS/RU) code are equipped with a voltage reduction device (VRD). The VRD is used for increased safety, especially in hazardous environments such as shipbuilding, pipe construction or mining.

A VRD is mandatory in some countries and required by many on-site safety instructions for power sources.

The VRD > see 4 chapter signal light is illuminated when the voltage reduction device is operating without fault and the output voltage is reduced to a value specified in the relevant standard (see technical data).

5.6 Machine configuration menu

Basic machine settings are defined in the machine configuration menu.

5.6.1 Selecting, changing and saving parameters

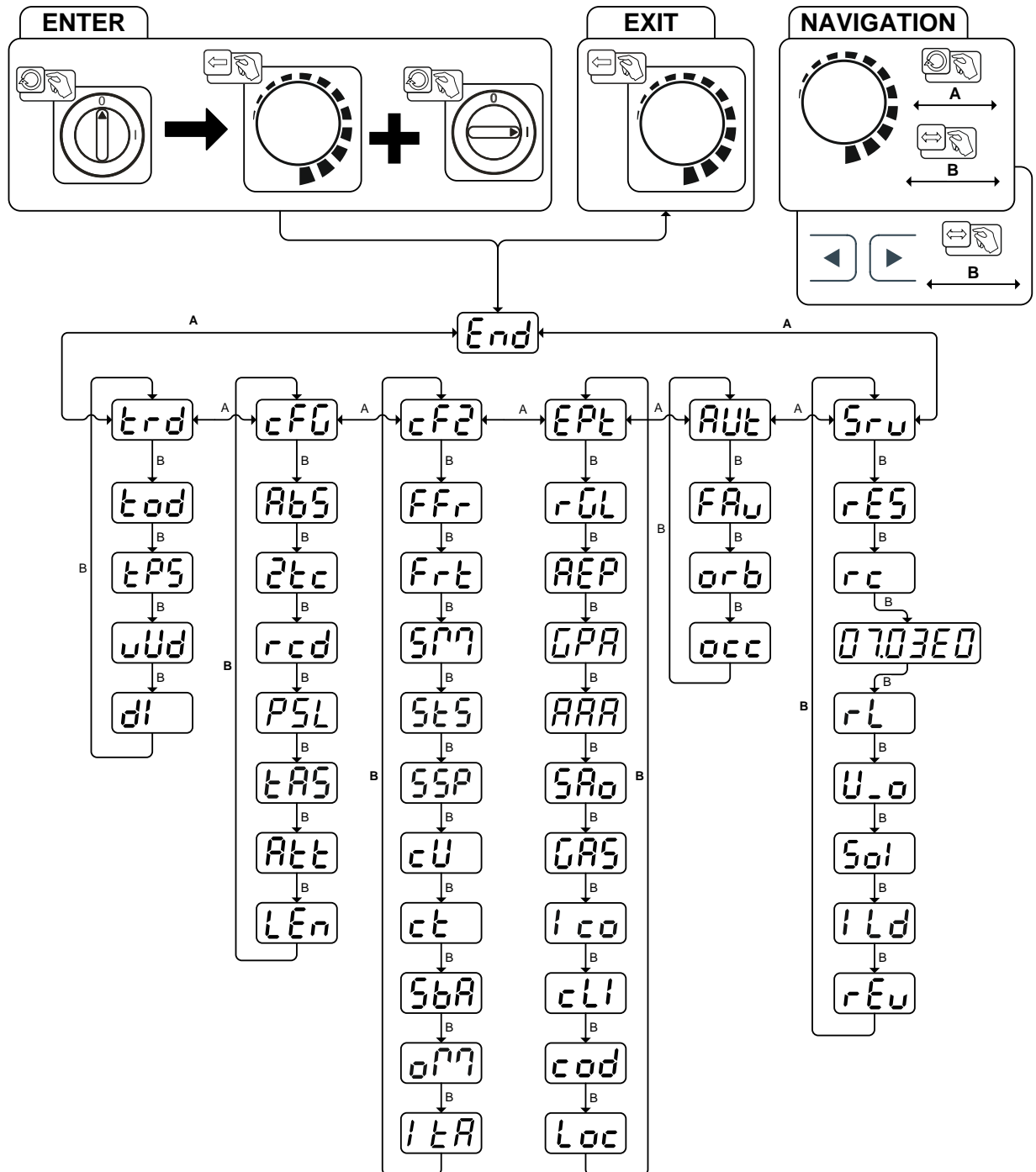
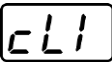

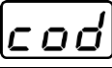
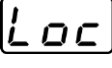



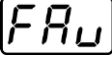

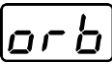

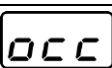

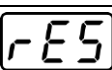



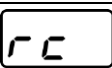



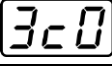

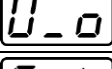
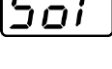

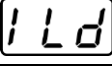
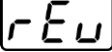

Figure 5-37

Display	Setting/selection
<code>End</code>	Exit the menu Exit
<code>trd</code>	Torch configuration menu Set welding torch functions
<code>tod</code>	Torch mode (ex works 1) > see 5.1.9.2 chapter

Display	Setting/selection
EP5	Alternative welding start – tapping start Available from torch mode 11 (welding stop by tapping remains active). <input type="checkbox"/> on ----- Function enabled (ex works) <input type="checkbox"/> off ----- Function disabled
uud	Up/down speed > see 5.1.9.3 chapter Increase value > rapid current change Decrease value > slow current change
dl	Current jump > see 5.1.9.4 chapter Current jump setting in ampere
cFG	Machine configuration Settings for machine functions and parameter display
Ab5	Absolute value setting (ignition, secondary, end and hot start current) > see 4.2.1 chapter <input type="checkbox"/> on ----- Welding current setting, absolute <input type="checkbox"/> off ----- Welding current setting, as a percentage of the main current (ex works)
2tc	Non-latched operation (version C) > see 5.1.5.6 chapter <input type="checkbox"/> on ----- Function enabled <input type="checkbox"/> off ----- Function disabled (ex works)
rcd	Welding current actual value display > see 4.2 chapter <input type="checkbox"/> on ----- Actual value display <input type="checkbox"/> off ----- Nominal value display
PSL	Pulsed TIG welding (thermic) in the upslope and downslope phases > see 5.1.6.1 chapter <input type="checkbox"/> on ----- Function enabled (ex works) <input type="checkbox"/> off ----- Function disabled
LR5	TIG antistick > see 5.1.8 chapter <input type="checkbox"/> on ----- function active (factory setting). <input type="checkbox"/> off ----- function inactive.
Alt	Show warnings > see 6.1 chapter <input type="checkbox"/> off ----- Function disabled (ex works) <input type="checkbox"/> on ----- Function enabled
LEn	Setting the system of units <input type="checkbox"/> mmm ----- Units of length in mm, m/min. (metric system) <input type="checkbox"/> inin ----- Unit of length in inches, ipm (imperial system)
cF2	Machine configuration (second part) Settings for machine functions and parameter display
FFr	RTF start ramp > see 5.1.10.1 chapter <input type="checkbox"/> on ----- Welding current rises to the specified main current level in a ramp function (ex works) <input type="checkbox"/> off ----- Welding current immediately jumps to the specified main current level
Frt	RTF response > see 5.1.10.2 chapter <input type="checkbox"/> Lin ----- Linear response <input type="checkbox"/> Log ----- Logarithmic responsive (ex works)
5m7	spotmatic operating mode > see 5.1.5.5 chapter Ignition by contact with the workpiece <input type="checkbox"/> on ----- Function enabled (ex works) <input type="checkbox"/> off ----- Function disabled
5t5	Spot time setting > see 5.1.5.5 chapter <input type="checkbox"/> on ----- Short spot time, setting range 5 ms to 999 ms, increments of 1 ms (ex works) <input type="checkbox"/> off ----- Long spot time, setting range 0.01 s to 20.0 s, increments of 10 ms (ex works)

Display	Setting/selection
55P	Process activation setting > see 5.1.5.5 chapter <input type="checkbox"/> on -----Separate process activation (ex works) <input type="checkbox"/> OFF-----Permanent process activation
CU	Torch cooling mode <input type="checkbox"/> AUT-----Automatic operation (ex works) <input type="checkbox"/> on -----Permanently enabled <input type="checkbox"/> OFF-----Permanently disabled
CT	Welding torch cooling, post-flow time Setting 1–60 min. (ex works 5 min.)
5bA	Time-based power-saving mode > see 5.3 chapter Time to activation of the power-saving mode in case of inactivity. Setting <input type="checkbox"/> OFF = disabled or numerical value 5-60 min..
077	Operating mode switching via interface for automated welding <input type="checkbox"/> 2E -----Non-latched <input type="checkbox"/> 2E5-----Special non-latched
1EA	Re-ignition after arc interruption > see 5.1.4.3 chapter <input type="checkbox"/> Job-----JOB-dependent time (ex works 5 s). <input type="checkbox"/> OFF-----Function disabled or numerical value 0.1–5.0 s.
EPT	Expert menu
rGL	AC average value controller ¹ <input type="checkbox"/> on -----Function enabled (ex works) <input type="checkbox"/> OFF-----Function disabled
REP	Reconditioning pulse (tungsten ball stability) ¹ Cleaning effect of the tungsten ball at the end of welding. <input type="checkbox"/> on -----Function enabled (ex works) <input type="checkbox"/> OFF-----Function disabled
GPA	Automatic gas post-flow function > see 5.1.1.1 chapter <input type="checkbox"/> on -----Function on <input type="checkbox"/> OFF-----Function off (factory setting)
AAA	activArc voltage measuring <input type="checkbox"/> on -----Function enabled (ex works) <input type="checkbox"/> OFF-----Function disabled
5A0	Error output to interface for automated welding, contact SYN_A <input type="checkbox"/> OFF-----AC synchronisation or hot wire (ex works) <input type="checkbox"/> F5n-----Error signal, negative logic <input type="checkbox"/> F5P-----Error signal, positive logic <input type="checkbox"/> AVC-----AVC (Arc voltage control) connection
GAS	Gas monitoring Depending on where the gas sensor is situated, the use of a pilot static tube and the welding process monitoring phase. <input type="checkbox"/> OFF-----Function disabled (ex works). <input type="checkbox"/> 1-----Monitoring during the welding process. Gas sensor between gas valve and welding torch (with pilot static tube). <input type="checkbox"/> 2-----Monitoring prior to the welding process. Gas sensor between gas valve and welding torch (without pilot static tube). <input type="checkbox"/> 3-----Permanent monitoring Gas sensor between gas cylinder and gas valve (with pilot static tube).
1CO	AC commutation optimisation > see 5.1.3.2 chapter ¹ <input type="checkbox"/> on -----Function enabled <input type="checkbox"/> OFF-----Function disabled (ex works)

Display	Setting/selection
	Minimum current limit (TIG) > see 5.1.2 chapter Depending on the set tungsten electrode diameter  ----- Function disabled  ----- Function enabled (ex works)
	Access control – access code Setting: 000 to 999 (000 ex works)
	Access control > see 5.4 chapter  ----- Function enabled  ----- Function disabled (ex works)
	Automation menu ³
	Fast take-over of control voltage (automation) ³  ----- Function enabled  ----- Function disabled (ex works)
	Orbital welding ³  ----- Function disabled (ex works)  ----- Function enabled
	Orbital welding ³ Correction value for orbital current
	Service menu Any changes to the service menu should be agreed with the authorised service personnel.
	Reset (to factory setting)  ----- Disabled (ex works)  ----- Reset the values in the machine configuration menu  ----- Complete reset of all values and settings Resetting is performed when exiting the menu (<i>End</i>).
	Automated/Manual (rC on/off) operating mode ³ Select machine/function control  -----with external control voltages/signals  -----with machine control
	Software version query (example) 07.=----- system bus ID
	03c0= --- version number System bus ID and version number are separated by a dot.
	Cable resistance alignment > see 5.1.12 chapter
	Only qualified service personnel may change the parameters!
	TIG HF start (soft/hard) switching  ----- soft ignition (factory setting).  ----- hard ignition.
	Ignition pulse limit Setting 0 ms–15 ms (increments of 1 ms)
	PCB state – qualified service personnel only!

¹ for AC welding machines only.

² not used

³ for components for automated welding (RC) only.

6 Rectifying faults

All products are subject to rigorous production checks and final checks. If, despite this, something fails to work at any time, please check the product using the following flowchart. If none of the fault rectification procedures described leads to the correct functioning of the product, please inform your authorised dealer.

6.1 Warnings

Depending on the display options of the machine display, a warning message is displayed as follows:

Display type - machine control	Display
Graphic display	
two 7-segment displays	
one 7-segment display	

The cause of the warning is indicated by a corresponding warning number (see table).

The display of possible warning numbers depends on the machine version (interfaces/functions).

- In case of multiple warnings, these are displayed in sequence.
- Document machine warning and inform service personnel, if required.



Warning code	Possible cause	Remedy
1	Machine excess temperature	Allow the machine to cool down
2	Half-wave failures	Check process parameters
3	Welding torch cooling warning	Check coolant level and refill if necessary
4	Gas warning	Check gas supply
5	See warning number 3	-
6	Welding consumable (wire electrode) fault	Check wire feeding (with machines with filler wire)
7	CAN bus failure	Inform service
16	Protective gas warning	Check gas supply
17	Plasma gas warning	Check gas supply
20	Coolant temperature warning	Check coolant level and refill if necessary
24	Coolant flow warning	Check coolant supply; check coolant level and, if necessary, fill up
28	Wire stock warning	Check wire feeding (with machines with filler wire)
32	Encoder malfunction, drive	Inform service
33	Drive is operating under overload conditions	Adjust mechanical load
34	JOB unknown	Select alternative JOB

The warnings can be reset by pressing a push-button (see table):

Machine control	Smart	Classic	Comfort	Smart 2 Comfort 2	Synergic
Push-button					

6.2 Error messages

Depending on the options of the machine display, a fault is shown as follows:

Display type - machine control	Display
Graphic display	
two 7-segment displays	
one 7-segment display	

The possible cause of the fault is signalled by a corresponding fault number (see table). In the case of an error, the power unit shuts down.

The display of possible error numbers depends on the machine version (interfaces/functions).

- If multiple errors occur, these are displayed in succession.
- Document machine errors and inform service staff as necessary.

Error	Possible cause	Remedy
3	Tacho error	Check wire guide / hose package.
	Wire feeder is not connected	Switch off cold wire mode in the machine configuration menu (off status). Connect the wire feeder.
4	Temperature error	Allow the machine to cool down.
	Error in the emergency stop circuit (interface for automated welding)	Check the external shutdown devices. Check the jumper JP 1 on PCB T320/1.
5	Overvoltage	Switch off the machine and check the mains voltage.
6	Undervoltage	
7	Coolant error (with connected cooling unit only).	Check coolant level and top up if necessary.
8	Gas error	Check the gas supply.
9	Secondary overvoltage	Switch the machine off and on. If the error persists, notify the service department.
10	PE error	
11	FastStop position	Slope "Acknowledge error" signal (0 to 1) using the robot interface (if present).
12	VRD error	Switch the machine off and on. If the error persists, notify the service department.
16	Pilot arc current	Check welding torch.
17	Filler wire error Excess current or deviation of the actual value from the wire target value.	Check the wire feed system (drives, hose packages, welding torches, process wire feed speed and robot travel speed) and correct if necessary.
18	Plasma gas error Target value specification deviates significantly from the actual value.	Check plasma gas supply (leak tightness, kinks, guide, connections, closure).
	Shielding gas error Target value specification deviates significantly from the actual value	
19	Shielding gas error Target value specification deviates significantly from the actual value	Check plasma gas supply (leak tightness, kinks, guide, connections, closure).
20	Coolant flow Coolant flow rate too low	Check cooling circuit (coolant level, leak tightness, kinks, guide, connections, closure).
22	Excess temperature in cooling circuit	Check cooling circuit (coolant level, temperature target value).
23	Excess temperature of the HF choke	Allow the machine to cool down. Adjust processing cycle times if necessary.
24	Pilot arc ignition error	Check the wear parts of the plasma torch.

Error	Possible cause	Remedy
32	Electronics error (I>0 error)	Switch the machine off and on. If the error persists, notify the service department.
33	Electronics error (Uact error)	
34	Electronics error (A/D channel error)	
35	Electronics error (slope error)	
36	Electronics error (S sign)	
37	Electronics error (temperature error)	Allow the machine to cool down.
38	---	Switch the machine off and on. If the error persists, notify the service department.
39	Electronics error (secondary overvoltage)	
40	Electronics error (I>0 error)	Inform service.
48	Ignition error	Check the welding process.
49	Arc interruption	Inform service.
51	Error in the emergency stop circuit (interface for automated welding)	Check the external shutdown devices. Check jumper JP 1 on PCB T320/1.
57	Auxiliary drive error, tacho error	Check the auxiliary drive (tacho – no signal, M3.51 defective > notify Service).
59	Incompatible component	Replace component.

6.3 Resetting welding parameters to the factory settings

All customised welding parameters that are stored will be replaced by the factory settings.

To reset the welding parameters or machine settings to the factory settings, select parameter **rES** in the service menu **Srv** > see 5.6 chapter.

6.4 Display machine control software version

The query of the software versions only serves to inform the authorised service staff. It is available in the machine configuration menu > see 5.6 chapter.

7 Appendix

7.1 Parameter overview – setting ranges

7.1.1 TIG welding

Name	Display			Setting range	
	Code	Standard	Unit	min.	max.
Main current AMP, depending on power source	[I]	-	A	-	-
Gas pre-flow time	[GPR]	0,5	s	0	20
Ignition current, percentage of AMP	[ISE]	20	%	1	200
Ignition current, absolute, depending on power source	[ISE]	-	A	-	-
Start time	[ESE]	0,01	s	0,01	20,0
Up-slope time	[EUP]	1,0	s	0,0	20,0
Pulse current	[IPL]	140	%	1	200
Pulse time ^[1]	[E I]	0,01	s	0,00	20,0
Slope time (time from main current AMP to secondary current AMP%)	[ESI]	0,00	s	0,00	20,0
Secondary current, percentage of AMP	[I 2]	50	%	1	200
Secondary current, absolute, depending on power source	[I 2]	-	A	-	-
Pulse pause time ^[1]	[E 2]	0,01	s	0,00	20,0
Slope time (time from main current AMP to secondary current AMP%)	[ES2]	0,00	s	0,00	20,0
Down-slope time	[Edn]	1,0	s	0,0	20,0
End current, percentage of AMP	[IEd]	20	%	1	200
End current, absolute, depending on power source	[IEd]	-	A	-	-
End current time	[EEd]	0,01	s	0,01	20,0
Gas post-flow time	[GPE]	8	s	0,0	40,0
Electrode diameter, metric	[ndR]	2,4	mm	1,0	4,0
Electrode diameter, imperial	[ndR]	92	mil	40	160
spotArc time	[E P]	2	s	0,01	20,0
spotmatic time ([SES] > [on])	[E P]	200	ms	5	999
spotmatic time ([SES] > [OFF])	[E P]	2	s	0,01	20,0
AC commutation optimisation ^{[1], [2], [3]}	[IC0]	250		5	375
AC balance (JOB 0) ^{[1], [2]}	[bRL]		%	-30	+30
AC balance (JOB 1-100) ^[2]	[bRL]	65	%	40	90
Current jump ^[3]	[dI]	1	A	1	20
Current jump ^[4]	[dI]	1	A	1	10
Re-igniting after arc interruption ^[3]	[IEA]	5	s	0,1	5
AC frequency ^[4]	[FRE]	-	Hz	50	200
AC frequency (JOB 0) ^{[1], [2], [3]}	[FRE]	-	Hz	30	300
AC frequency (JOB 1-100) ^{[1], [2]}	[FRE]	50	Hz	30	300
Pulse balance	[bRL]	50	%	1	99
Pulse frequency (mean value pulsing, DC voltage)	[FRE]	2,8	Hz	0,2	2000
Pulse frequency (mean value pulsing, DC voltage) ^[1]	[FRE]	2,8	Hz	0,2	5
Pulse frequency (metallurgical pulsing) ^[3]	[FRE]	50	Hz	50	15000
Pulse frequency (metallurgical pulsing) ^[4]	[FRE]	50	Hz	5	15000
activArc, depending on main current	[AAP]			0	100

Name	Display			Setting range	
	Code	Standard	Unit	min.	max.
Amplitude balance ^{[1], [2], [3]}	AbB			70	- 130
Dynamic power adjustment ^[4]	FUS	16	A	10	/ 16

- [1] Machines with control Comfort 2.0.
 [2] Machines for AC welding (AC).
 [3] Machine series Tetric 300.
 [4] Machine series Tetric 230.

7.1.2 MMA welding

Name	Display			Setting range	
	Code	Standard	Unit	min.	max.
Main current AMP, depending on power source	i	-	A	-	- -
Hot start current, percentage of AMP	i hE	120	%	1	- 200
Hot start current, percentage of AMP ^[1]	i hE	150	%	1	- 150
Hot start current, absolute, depending on power source	i hE	-	A	-	- -
Hot start time	t hE	0,5	s	0,0	- 10,0
Hot start time ^[1]	t hE	0,1	s	0,0	- 5,0
Arcforce ^[2]	ARc	0		-40	- 40
AC frequency ^{[2] [3]}	FrE	100	Hz	30	- 300
AC balance ^{[2] [3]}	bAL	60	%	40	- 90
Pulse current	i PL	142	-	1	- 200
Pulse frequency	FrE	1,2	Hz	0,2	- 50
Pulse frequency (DC)	FrE	1,2	Hz	0,2	- 500
Pulse frequency (AC) ^{[2] [3]}	FrE	1,2	Hz	0,2	- 5
Pulse balance	bAL	30	-	1	- 99
Dynamic power adjustment ^[1]	FUS	16	A	10	/ 16

- [1] Machine series Tetric 230.
 [2] Machine series Tetric 300.
 [3] Machines for AC welding (AC).

7.2 Searching for a dealer

Sales & service partners
www.ewm-group.com/en/specialist-dealers



"More than 400 EWM sales partners worldwide"