

Welding machine

**Phoenix 401 Progress puls LP MM FKW**  
**Phoenix 501 Progress puls LP MM FKW**

099-005504-EW501

20.11.2015

**Register now  
and benefit!**  
**Jetzt Registrieren  
und Profitieren!**

[www.ewm-group.com](http://www.ewm-group.com)



# General instructions

## CAUTION



### **Read the operating instructions!**

**The operating instructions provide an introduction to the safe use of the products.**

- Read the operating instructions for all system components!
- Observe accident prevention regulations!
- Observe all local regulations!
- Confirm with a signature where appropriate.



***In the event of queries on installation, commissioning, operation or special conditions at the installation site, or on usage, please contact your sales partner or our customer service department on +49 2680 181-0.***

***A list of authorised sales partners can be found at [www.ewm-group.com](http://www.ewm-group.com).***

Liability relating to the operation of this equipment is restricted solely to the function of the equipment. No other form of liability, regardless of type, shall be accepted. This exclusion of liability shall be deemed accepted by the user on commissioning the equipment.

The manufacturer is unable to monitor whether or not these instructions or the conditions and methods are observed during installation, operation, usage and maintenance of the equipment. An incorrectly performed installation can result in material damage and injure persons as a result. For this reason, we do not accept any responsibility or liability for losses, damages or costs arising from incorrect installation, improper operation or incorrect usage and maintenance or any actions connected to this in any way.

© EWM AG · Dr. Günter-Henle-Str. 8 · D-56271 Mündersbach, Germany

The copyright to this document remains the property of the manufacturer.

Reprinting, including extracts, only permitted with written approval.

The content of this document has been prepared and reviewed with all reasonable care. The information provided is subject to change, errors excepted.

# 1 Contents

<b>1</b>	<b>Contents</b>	<b>3</b>
<b>2</b>	<b>Safety instructions</b>	<b>7</b>
2.1	Notes on the use of these operating instructions	7
2.2	Explanation of icons	8
2.3	General	9
2.4	Transport and installation	13
2.4.1	Lifting by crane	14
2.4.2	Ambient conditions	15
2.4.2.1	In operation	15
2.4.2.2	Transport and storage	15
<b>3</b>	<b>Intended use</b>	<b>16</b>
3.1	Applications	16
3.1.1	MIG/MAG standard welding	16
3.1.1.1	forceArc	16
3.1.1.2	rootArc	16
3.1.2	MIG/MAG pulse welding	16
3.1.2.1	forceArc puls	16
3.1.2.2	rootArc puls	16
3.1.3	TIG (Liftarc) welding	16
3.1.4	MMA welding	16
3.1.4.1	Air arc gouging	16
3.2	Documents which also apply	17
3.2.1	Warranty	17
3.2.2	Declaration of Conformity	17
3.2.3	Welding in environments with increased electrical hazards	17
3.2.4	Service documents (spare parts and circuit diagrams)	17
3.2.5	Calibration/Validation	17
<b>4</b>	<b>Machine description – quick overview</b>	<b>18</b>
4.1	Front view	18
4.2	Rear view	20
4.3	Inside view	22
4.4	Machine control – Operating elements	24
<b>5</b>	<b>Design and function</b>	<b>26</b>
5.1	General	26
5.2	Installation	27
5.3	Machine cooling	27
5.4	Workpiece lead, general	27
5.5	Notes on the installation of welding current leads	28
5.6	Welding torch cooling system	30
5.6.1	List of coolants	30
5.6.2	Maximal hose package length	30
5.6.3	Adding coolant	31
5.7	Mains connection	32
5.7.1	Mains configuration	32
5.8	Shielding gas supply (shielding gas cylinder for welding machine)	33
5.8.1	Gas test	34
5.8.2	Rinse hose package function	34
5.8.2.1	Setting the shielding gas quantity	34
5.9	Welding data display	35
5.10	MIG/MAG welding	36
5.10.1	Welding torch and workpiece line connection	36
5.10.2	Wire feed	39
5.10.2.1	Open the protective flap of the wire feeder	39
5.10.2.2	Inserting the wire spool	39
5.10.2.3	Changing the wire feed rollers	40
5.10.2.4	Inching the wire electrode	42

5.10.2.5	Spool brake setting.....	44
5.10.3	Definition of MIG/MAG welding tasks .....	45
5.10.4	Welding task selection .....	45
5.10.4.1	Basic welding parameters .....	45
5.10.4.2	Operating mode.....	45
5.10.4.3	Choke effect / dynamics .....	46
5.10.5	MIG/MAG operating point .....	47
5.10.5.1	Selecting the display unit.....	47
5.10.5.2	Operating point setting using material thickness .....	47
5.10.5.3	Arc length correction setting.....	48
5.10.5.4	Accessory components for operating point setting .....	48
5.10.6	forceArc / forceArc puls .....	49
5.10.7	rootArc/rootArc puls .....	50
5.10.8	MIG/MAG functional sequences / operating modes.....	51
5.10.9	Explanation of signs and functions .....	51
5.10.10	MIG/MAG program sequence ("Program steps" mode) .....	57
5.10.10.1	Example, tack welding (non-latched) .....	58
5.10.10.2	Example, aluminium tack welding (non-latched special) .....	58
5.10.10.3	Example, aluminium welding (latched special) .....	58
5.10.11	Main program A mode .....	59
5.10.11.1	Selecting parameters (program A) .....	61
5.10.12	MIG/MAG automatic cut-out .....	61
5.10.13	Standard MIG/MAG torch .....	62
5.10.14	MIG/MAG special-torches.....	62
5.10.14.1	Program- and Up- / down operation.....	62
5.10.14.2	Switching between Push/Pull and intermediate drive .....	62
5.11	TIG welding .....	63
5.11.1	Welding torch and workpiece line connection .....	63
5.11.2	Welding task selection .....	64
5.11.2.1	Welding current setting.....	64
5.11.3	TIG arc ignition .....	64
5.11.3.1	Liftarc ignition .....	64
5.11.4	Function sequences/operating modes.....	65
5.11.4.1	Explanation of signs and functions.....	65
5.11.4.2	TIG automatic cut-out.....	68
5.12	MMA welding.....	69
5.12.1	Connecting the electrode holder and workpiece lead .....	69
5.12.2	Welding task selection .....	70
5.12.2.1	Welding current setting.....	70
5.12.2.2	Arcforce .....	70
5.12.2.3	Hotstart .....	70
5.12.2.4	Antistick .....	70
5.13	Remote control.....	71
5.14	Interfaces for automation .....	71
5.14.1	Automation interface.....	72
5.14.2	Remote control connection socket, 19-pole .....	73
5.14.3	RINT X12 robot interface .....	74
5.14.4	BUSINT X11 Industrial bus interface .....	74
5.15	PC Interfaces .....	74
5.16	Protecting welding parameters from unauthorised access .....	75
5.17	Special parameters (advanced settings).....	75
5.17.1	Selecting, changing and saving parameters.....	75
5.17.1.1	Reset to factory settings.....	78
5.17.1.2	Special parameters in detail .....	79
5.18	Machine configuration menu .....	88
5.18.1	Selecting, changing and saving parameters.....	88
5.18.2	Aligning the cable resistance .....	89
5.18.3	Power-saving mode (Standby) .....	90
<b>6</b>	<b>Maintenance, care and disposal .....</b>	<b>91</b>
6.1	General.....	91

6.2	Maintenance work, intervals .....	91
6.2.1	Daily maintenance tasks .....	91
6.2.1.1	Visual inspection .....	91
6.2.1.2	Functional test.....	91
6.2.2	Monthly maintenance tasks.....	92
6.2.2.1	Visual inspection .....	92
6.2.2.2	Functional test.....	92
6.2.3	Annual test (inspection and testing during operation) .....	92
6.3	Disposing of equipment .....	92
6.3.1	Manufacturer's declaration to the end user .....	92
6.4	Meeting the requirements of RoHS .....	92
<b>7</b>	<b>Rectifying faults .....</b>	<b>93</b>
7.1	Checklist for rectifying faults .....	93
7.2	Error messages.....	94
7.3	Resetting JOBs (welding tasks) to the factory settings .....	96
7.3.1	Resetting a single JOB .....	96
7.3.2	Resetting all JOBs .....	97
7.4	General operating problems .....	97
7.4.1	Interface for automated welding.....	97
7.5	Vent coolant circuit.....	98
<b>8</b>	<b>Technical data .....</b>	<b>99</b>
8.1	Phoenix 401 Progress FKW .....	99
8.2	Phoenix 501 Progress FKW .....	100
<b>9</b>	<b>Accessories .....</b>	<b>101</b>
9.1	General accessories .....	101
9.2	Remote control/connecting and extension cable .....	101
9.2.1	7-pole connection .....	101
9.2.2	19-pole connection .....	101
9.3	Options.....	102
9.4	Computer communication .....	102
<b>10</b>	<b>Replaceable parts .....</b>	<b>103</b>
10.1	Wire feed rollers.....	103
10.1.1	Wire feed rollers for steel wire .....	103
10.1.2	Wire feed rollers for aluminium wire .....	104
10.1.3	Wire feed rollers for cored wire .....	104
10.1.4	Wire guide .....	104
<b>11</b>	<b>Appendix A .....</b>	<b>105</b>
11.1	JOB-List .....	105
<b>12</b>	<b>Appendix B .....</b>	<b>106</b>
12.1	Overview of EWM branches .....	106



## 2 Safety instructions

### 2.1 Notes on the use of these operating instructions

#### DANGER

**Working or operating procedures which must be closely observed to prevent imminent serious and even fatal injuries.**

- Safety notes include the "DANGER" keyword in the heading with a general warning symbol.
- The hazard is also highlighted using a symbol on the edge of the page.

#### WARNING

**Working or operating procedures which must be closely observed to prevent serious and even fatal injuries.**

- Safety notes include the "WARNING" keyword in the heading with a general warning symbol.
- The hazard is also highlighted using a symbol in the page margin.

#### CAUTION

**Working or operating procedures which must be closely observed to prevent possible minor personal injury.**

- The safety information includes the "CAUTION" keyword in its heading with a general warning symbol.
- The risk is explained using a symbol on the edge of the page.

#### CAUTION

**Working and operating procedures which must be followed precisely to avoid damaging or destroying the product.**















- The safety information includes the "CAUTION" keyword in its heading without a general warning symbol.
- The hazard is explained using a symbol at the edge of the page.

#### **Special technical points which users must observe.**

Instructions and lists detailing step-by-step actions for given situations can be recognised via bullet points, e.g.:

- Insert the welding current lead socket into the relevant socket and lock.

## 2.2 Explanation of icons

Symbol	Description
	Special technical points which users must observe.
	Correct
	Wrong
	Press
	Do not press
	Press and keep pressed
	Turn
	Switch
	Switch off machine
	Switch on machine
<b>ENTER</b>	enter the menu
<b>NAVIGATION</b>	Navigating in the menu
<b>EXIT</b>	Exit the menu
4 s 	Time display (example: wait 4s/press)
	Interruption in the menu display (other setting options possible)
	Tool not required/do not use
	Tool required/use



## 2.3 General

### DANGER



#### **Electric shock!**

**Welding machines use high voltages which can result in potentially fatal electric shocks and burns on contact. Even low voltages can cause you to get a shock and lead to accidents.**

- Do not touch any live parts in or on the machine!
- Connection cables and leads must be free of faults!
- Switching off alone is not sufficient!
- Place welding torch and stick electrode holder on an insulated surface!
- The unit should only be opened by specialist staff after the mains plug has been unplugged!
- Only wear dry protective clothing!
- Wait for 4 minutes until the capacitors have discharged!



#### **Electromagnetic fields!**

**The power source may cause electrical or electromagnetic fields to be produced which could affect the correct functioning of electronic equipment such as IT or CNC devices, telecommunication lines, power cables, signal lines and pacemakers.**

- Observe the maintenance instructions - See 6 Maintenance, care and disposal chapter!
- Unwind welding leads completely!
- Shield devices or equipment sensitive to radiation accordingly!
- The correct functioning of pacemakers may be affected (obtain advice from a doctor if necessary).



#### **Do not carry out any unauthorised repairs or modifications!**

**To avoid injury and equipment damage, the unit must only be repaired or modified by specialist, skilled persons!**

**The warranty becomes null and void in the event of unauthorised interference.**

- Appoint only skilled persons for repair work (trained service personnel)!

### WARNING



#### **Risk of accidents due to non-compliance with the safety instructions!**

**Non-compliance with the safety instructions can be fatal!**

- Carefully read the safety instructions in this manual!
- Observe the accident prevention regulations and any regional regulations!
- Inform persons in the working area that they must comply with the regulations!



#### **Risk of injury due to radiation or heat!**

**Arc radiation results in injury to skin and eyes.**

**Contact with hot workpieces and sparks results in burns.**

- Use welding shield or welding helmet with the appropriate safety level (depending on the application)!
- Wear dry protective clothing (e.g. welding shield, gloves, etc.) according to the relevant regulations in the country in question!
- Protect persons not involved in the work against arc beams and the risk of glare using safety curtains!

## WARNING



### **Explosion risk!**

**Apparently harmless substances in closed containers may generate excessive pressure when heated.**

- Move containers with inflammable or explosive liquids away from the working area!
- Never heat explosive liquids, dusts or gases by welding or cutting!



### **Smoke and gases!**

**Smoke and gases can lead to breathing difficulties and poisoning. In addition, solvent vapour (chlorinated hydrocarbon) may be converted into poisonous phosgene due to the ultraviolet radiation of the arc!**

- Ensure that there is sufficient fresh air!
- Keep solvent vapour away from the arc beam field!
- Wear suitable breathing apparatus if appropriate!



### **Fire hazard!**

**Flames may arise as a result of the high temperatures, stray sparks, glowing-hot parts and hot slag produced during the welding process.**

**Stray welding currents can also result in flames forming!**

- Check for fire hazards in the working area!
- Do not carry any easily flammable objects such as matches or lighters.
- Keep appropriate fire extinguishing equipment to hand in the working area!
- Thoroughly remove any residue of flammable substances from the workpiece before starting welding.
- Only continue work on welded workpieces once they have cooled down.  
Do not allow to come into contact with flammable material!
- Connect welding leads correctly!



### **Danger when coupling multiple power sources!**

**Coupling multiple power sources in parallel or in series has to be carried out by qualified personnel and in accordance with the manufacturer's guidelines. Before bringing the power sources into service for arc welding operations, a test has to verify that they cannot exceed the maximum allowed open circuit voltage.**

- Connection of the machine may be carried out by qualified personnel only!
- When decommissioning individual power sources, all mains and welding current leads have to be safely disconnected from the welding system as a whole. (Danger due to inverse voltages!)
- Do not couple welding machines with pole reversing switch (PWS series) or machines for AC welding, as a minor error in operation can cause the welding voltages to be combined.

## CAUTION



### **Noise exposure!**

**Noise exceeding 70 dBA can cause permanent hearing damage!**

- Wear suitable ear protection!
- Persons located within the working area must wear suitable ear protection!

**CAUTION****Obligations of the operator!****The respective national directives and laws must be observed for operation of the machine!**

- National implementation of the framework directive (89/391/EEG), as well as the associated individual directives.
- In particular, directive (89/655/EEG), on the minimum regulations for safety and health protection when staff members use equipment during work.
- The regulations regarding work safety and accident prevention for the respective country.
- Setting up and operating the machine according to IEC 60974-9.
- Check at regular intervals that users are working in a safety-conscious way.
- Regular checks of the machine according to IEC 60974-4.

**Damage due to the use of non-genuine parts!****The manufacturer's warranty becomes void if non-genuine parts are used!**

- Only use system components and options (power sources, welding torches, electrode holders, remote controls, spare parts and replacement parts, etc.) from our range of products!
- Only insert and lock accessory components into the relevant connection socket when the machine is switched off.

**Damage to the machine due to stray welding currents!****Stray welding currents can destroy protective earth conductors, damage equipment and electronic devices and cause overheating of components leading to fire.**

- Make sure all welding leads are securely connected and check regularly.
- Always ensure a proper and secure electrical connection to the workpiece!
- Set up, attach or suspend all conductive power source components like casing, transport vehicle and crane frames so they are insulated!
- Do not place any other electronic devices such as drillers or angle grinders, etc., on the power source, transport vehicle or crane frames unless they are insulated!
- Always put welding torches and electrode holders on an insulated surface when they are not in use!

**Mains connection****Requirements for connection to the public mains network**

High-performance machines can influence the mains quality by taking current from the mains network. For some types of machines, connection restrictions or requirements relating to the maximum possible line impedance or the necessary minimum supply capacity at the interface with the public network (Point of Common Coupling, PCC) can therefore apply. In this respect, attention is also drawn to the machines' technical data. In this case, it is the responsibility of the operator, where necessary in consultation with the mains network operator, to ensure that the machine can be connected.

## CAUTION



### EMC Machine Classification

In accordance with IEC 60974-10, welding machines are grouped in two electromagnetic compatibility classes - See 8 Technical data chapter:

**Class A** machines are not intended for use in residential areas where the power supply comes from the low-voltage public mains network. When ensuring the electromagnetic compatibility of class A machines, difficulties can arise in these areas due to interference not only in the supply lines but also in the form of radiated interference.

**Class B** machines fulfil the EMC requirements in industrial as well as residential areas, including residential areas connected to the low-voltage public mains network.

### Setting up and operating

When operating arc welding systems, in some cases, electro-magnetic interference can occur although all of the welding machines comply with the emission limits specified in the standard. The user is responsible for any interference caused by welding.

In order to **evaluate** any possible problems with electromagnetic compatibility in the surrounding area, the user must consider the following: (see also EN 60974-10 Appendix A)

- Mains, control, signal and telecommunication lines
- Radios and televisions
- Computers and other control systems
- Safety equipment
- The health of neighbouring persons, especially if they have a pacemaker or wear a hearing aid
- Calibration and measuring equipment
- The immunity to interference of other equipment in the surrounding area
- The time of day at which the welding work must be carried out

### Recommendations for **reducing interference emission**

- Mains connection, e.g. additional mains filter or shielding with a metal tube
- Maintenance of the arc welding equipment
- Welding leads should be as short as possible and run closely together along the ground
- Potential equalization
- Earthing of the workpiece. In cases where it is not possible to earth the workpiece directly, it should be connected by means of suitable capacitors.
- Shielding from other equipment in the surrounding area or the entire welding system

## 2.4 Transport and installation

### WARNING



#### **Incorrect handling of shielding gas cylinders!**

**Incorrect handling of shielding gas cylinders can result in serious and even fatal injury.**

- Observe the instructions from the gas manufacturer and in any relevant regulations concerning the use of compressed air!
- Place shielding gas cylinders in the holders provided for them and secure with fixing devices.
- Avoid heating the shielding gas cylinder!

### CAUTION



#### **Risk of tipping!**

**There is a risk of the machine tipping over and injuring persons or being damaged itself during movement and set up. Tilt resistance is guaranteed up to an angle of 10° (according to EN 60974-A2).**

- Set up and transport the machine on level, solid ground!
- Secure add-on parts using suitable equipment!
- Replace damaged wheels and their fixing elements!
- Fix external wire feed units during transport (avoid uncontrolled rotation)!



#### **Damage due to supply lines not being disconnected!**

**During transport, supply lines which have not been disconnected (mains supply leads, control leads, etc.) may cause hazards such as connected equipment tipping over and injuring persons!**

- Disconnect supply lines!

### CAUTION



#### **Equipment damage when not operated in an upright position!**

**The units are designed for operation in an upright position!**

**Operation in non-permissible positions can cause equipment damage.**

- Only transport and operate in an upright position!

## 2.4.1 Lifting by crane

### WARNING



#### Risk of injury during lifting by crane!

**When lifting the machine by crane, persons may be severely injured by falling machines or mount-on components.**

- Simultaneous lifting of system components such as power source, wire feeder or cooling unit without suitable crane components is not allowed. Each system component has to be lifted separately!
- Remove any supply leads and accessories before lifting by crane (e.g. hose package, wire spool, shielding gas cylinder, toolbox, wire feeder, remote control, etc.!)!
- Properly close and lock all casing covers and protective caps before lifting by crane!
- Use the correct number of hoisting equipment of the right size in the correct position! Observe craning principle (see figure)!
- For machines with lifting eyes: always lift all lifting eyes simultaneously!
- When using retrofitted craning frames etc.: always use at least two lifting points positioned as far apart as possible – observe option description.
- Avoid any jerky movements!
- Ensure that the load is distributed evenly! • Use chain hoists and chain slings of the same length only!
- Stay outside the danger zone underneath the machine!
- Observe the regulations regarding occupational safety and accident prevention for the respective country.

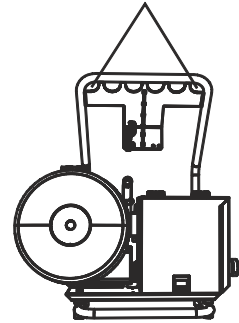
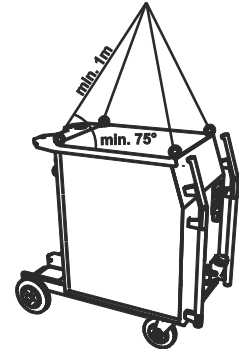

Craning principle



#### Risk of injury due to unsuitable lifting eye!

**In case of improper use of lifting eyes or the use of unsuitable lifting eyes, persons can be seriously damaged by falling equipment or add-on components!**

- The lifting eye must be completely screwed in!
- The lifting eye must be positioned flat onto and in full contact with the supporting surfaces!
- Check that the lifting eyes are securely fastened before use and check for any damage (corrosion, deformation)!
- Do not use or screw in damaged lifting eyes!
- Avoid lateral loading of the lifting eyes!

## 2.4.2 Ambient conditions

### CAUTION



#### Installation site!

**The machine must not be operated in the open air and must only be set up and operated on a suitable, stable and level base!**

- The operator must ensure that the ground is non-slip and level, and provide sufficient lighting for the place of work.
- Safe operation of the machine must be guaranteed at all times.

### CAUTION



#### Equipment damage due to dirt accumulation!

**Unusually high quantities of dust, acid, corrosive gases or substances may damage the equipment.**

- Avoid high volumes of smoke, vapour, oil vapour and grinding dust!
- Avoid ambient air containing salt (sea air)!



#### Non-permissible ambient conditions!

**Insufficient ventilation results in a reduction in performance and equipment damage.**

- Observe the ambient conditions!
- Keep the cooling air inlet and outlet clear!
- Observe the minimum distance of 0.5 m from obstacles!

### 2.4.2.1 In operation

**Temperature range of the ambient air:**

- -25 °C to +40 °C

**Relative air humidity:**

- Up to 50% at 40 °C
- Up to 90% at 20 °C

### 2.4.2.2 Transport and storage

**Storage in an enclosed space, temperature range of the ambient air:**

- -30 °C to +70 °C

**Relative air humidity**

- Up to 90% at 20 °C

## 3 Intended use

### **WARNING**



#### **Hazards due to improper usage!**

**Hazards may arise for persons, animals and material objects if the equipment is not used correctly. No liability is accepted for any damages arising from improper usage!**

- The equipment must only be used in line with proper usage and by trained or expert staff!
- Do not modify or convert the equipment improperly!

### 3.1 Applications

#### 3.1.1 MIG/MAG standard welding

Metal arc welding using a wire electrode, where the arc and the weld pool are shielded from the atmosphere with inert (MIG) or active (MAG) gasses or gas mixtures.

##### 3.1.1.1 forceArc

Low-heat, directionally stable and powerful high-performance arc with deep fusion penetration for the upper power range Unalloyed, low-alloy and high-alloy steels as well as high-tensile fine-grained steels.

##### 3.1.1.2 rootArc

Short arc with perfect weld modelling capabilities for effortless gap bridging, especially for positional welding

#### 3.1.2 MIG/MAG pulse welding

Welding process for optimum welding results when joining unalloyed, low-alloy and high-alloy steels and aluminium thanks to controlled droplet transfer and targeted, adapted heat input.

##### 3.1.2.1 forceArc puls

Effective extension of the forceArc arc. Secure sidewall fusion, easy to model and control by the user. Ideal for welding filler and final passes in all power ranges and positions.

##### 3.1.2.2 rootArc puls

The perfect enhancement for focused heat input for the higher performance range

#### 3.1.3 TIG (Liftarc) welding

TIG welding procedure with arc striking by contact with the workpiece and subsequent removal of the electrode.

#### 3.1.4 MMA welding

Manual arc welding or, for short, MMA welding. It is characterised by the fact that the arc burns between a melting electrode and the molten pool. There is no external protection; any protection against the atmosphere comes from the electrode.

##### 3.1.4.1 Air arc gouging

During gouging, an arc burns between a carbon electrode and the workpiece, heating the workpiece until it is molten. At the same time, the molten metal is blown out with compressed air. Special electrode holders with a compressed-air connection and carbon electrodes are required for gouging.



## 3.2 Documents which also apply

### 3.2.1 Warranty



For more information refer to the "Warranty registration" brochure supplied and our information regarding warranty, maintenance and testing at [www.ewm-group.com](http://www.ewm-group.com)!

### 3.2.2 Declaration of Conformity



The designated machine conforms to EC Directives and standards in terms of its design and construction:

- EC Low Voltage Directive (2006/95/EC),
- EC EMC Directive (2004/108/EC),

This declaration shall become null and void in the event of unauthorised modifications, improperly conducted repairs, non-observance of the deadlines for the repetition test and / or non-permitted conversion work not specifically authorised by the manufacturer.

The original copy of the declaration of conformity is enclosed with the unit.

### 3.2.3 Welding in environments with increased electrical hazards



In compliance with IEC / DIN EN 60974, VDE 0544 the machines can be used in environments with an increased electrical hazard.

### 3.2.4 Service documents (spare parts and circuit diagrams)



#### DANGER



**Do not carry out any unauthorised repairs or modifications!**

**To avoid injury and equipment damage, the unit must only be repaired or modified by specialist, skilled persons!**

**The warranty becomes null and void in the event of unauthorised interference.**

- Appoint only skilled persons for repair work (trained service personnel)!

Original copies of the circuit diagrams are enclosed with the unit.

Spare parts can be obtained from the relevant authorised dealer.

### 3.2.5 Calibration/Validation

We hereby confirm that this machine has been tested using calibrated measuring equipment, as stipulated in IEC/EN 60974, ISO/EN 17662, EN 50504, and complies with the admissible tolerances.

Recommended calibration interval: 12 months

## 4 Machine description – quick overview

### 4.1 Front view

**Coolant tank and quick connect coupling of coolant supply and return are only fitted in machines with water cooling.**

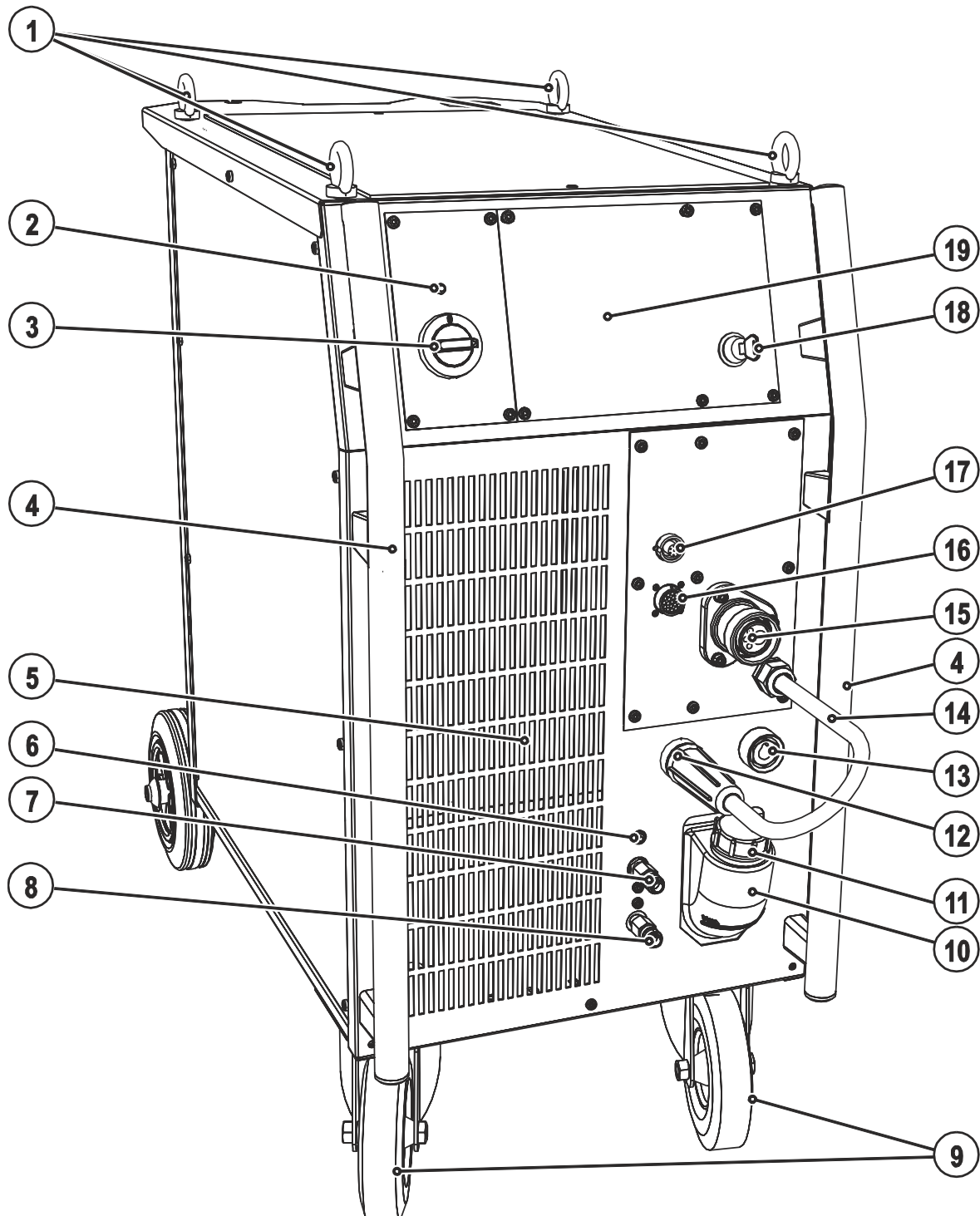

Figure 4-1

Item	Symbol	Description
1		Lifting lug
2		Ready for operation signal light Signal light on when the machine is switched on and ready for operation

Item	Symbol	Description
3		<b>Main switch, machine on/off</b>
4		<b>Carrying handle</b>
5		<b>Cooling air inlet</b>
6		<b>Automatic cut-out of coolant pump key button</b> press to reset a triggered fuse
7		<b>Quick connect coupling (red)</b> coolant return
8		<b>Quick connect coupling (blue)</b> coolant supply
9		<b>Wheels, guide castors</b>
10		<b>Coolant tank</b>
11		<b>Coolant tank cap</b>
12		<b>"-" welding current connection socket</b> <ul style="list-style-type: none"> <li>• MIG/MAG welding: Workpiece connection</li> <li>• MIG/MAG cored wire welding: Welding current to central connection/torch</li> <li>• TIG welding: Welding current connection for welding torch</li> <li>• MMA welding: Workpiece or electrode holder connection</li> </ul>
13		<b>Connection socket, "+" welding current</b> <ul style="list-style-type: none"> <li>• MIG/MAG welding: Welding current to central connection/torch</li> <li>• MIG/MAG cored wire welding: Workpiece connection</li> <li>• TIG welding: Workpiece connection</li> <li>• MMA welding: Workpiece or electrode holder connection</li> </ul>
14		<b>Welding current cable, polarity selection</b> Welding current to Euro torch connector/torch, for polarity selection <ul style="list-style-type: none"> <li>• MIG/MAG: Connection socket for "+" welding current</li> <li>• Self-shielding flux cored wire/TIG: Connection socket, "-" welding current</li> <li>• MMA: Park socket</li> </ul>
15		<b>Welding torch connection (Euro or Dinse torch connector)</b> Welding current, shielding gas and torch trigger integrated
16		<b>19-pole connection socket (analogue)</b> For connecting analogue accessory components (remote control, welding torch control lead, etc.)
17		<b>7-pole connection socket (digital)</b> For connecting digital accessory components (documentation interface, robot interface or remote control, etc.).
<b>▼ optional, factory-fitted ▼</b>		
18		<b>Key switch for protection against unauthorised use</b> Position "1" > changes possible, Position "0" > changes not possible.  - See 5.16 Protecting welding parameters from unauthorised access chapter
<b>▲ optional, factory-fitted ▲</b>		
19		<b>Machine control- See 4.4 Machine control – Operating elements chapter</b>

## 4.2 Rear view

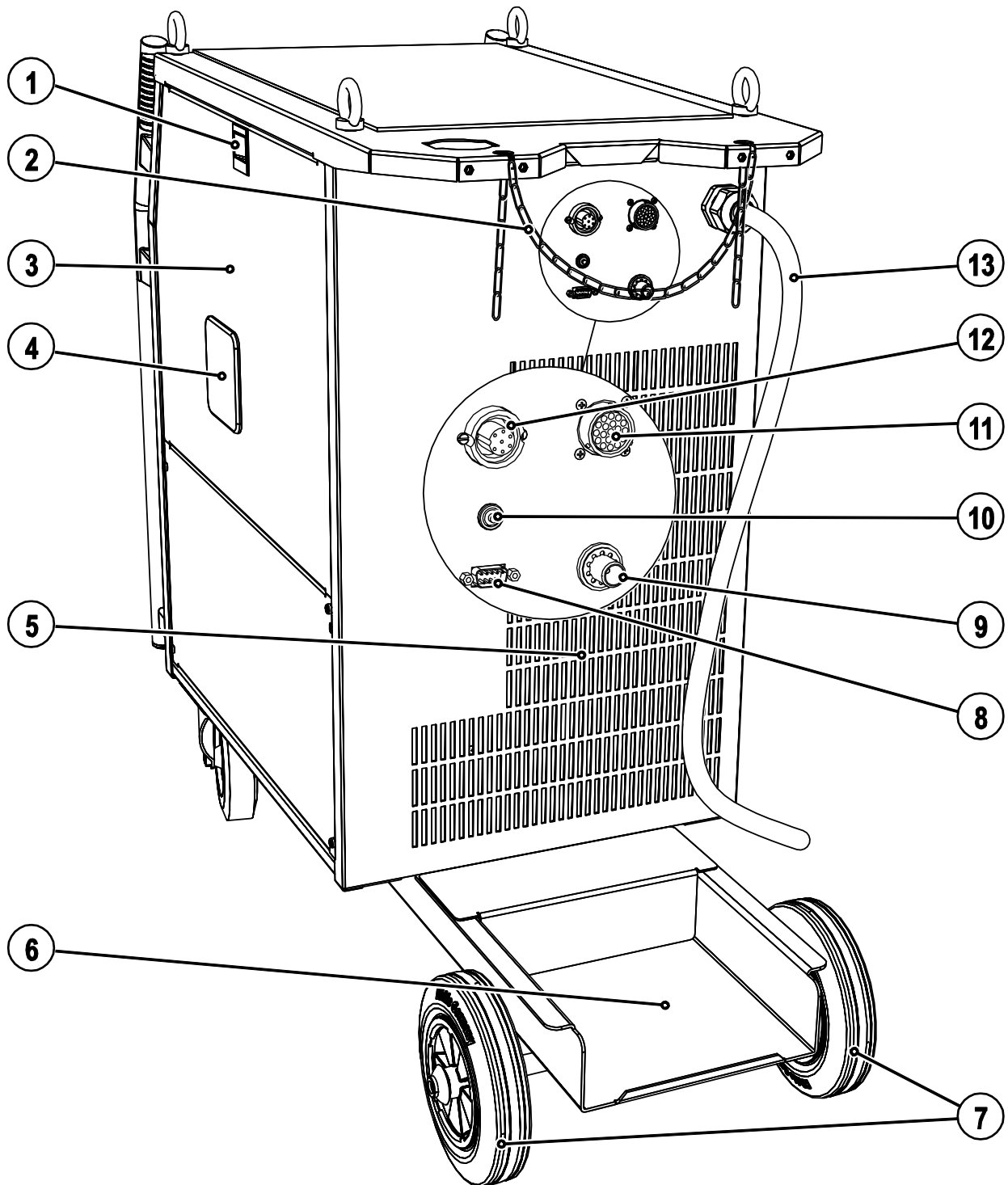







Figure 4-2

Item	Symbol	Description
1		<b>Slide latch, lock for the protective cap</b>
2		<b>Securing elements for shielding gas cylinder (strap/chain)</b>
3		<b>Protective cap</b> Cover for the wire feed mechanism and other operating elements. Depending on the machine series, additional stickers with information on the replacement parts and JOB lists will be located on the inside.
4		<b>Wire spool inspection window</b> Check wire supply
5		<b>Cooling air outlet</b>
6		<b>Bracket for shielding gas cylinder</b>
7		<b>Wheels, fixed castors</b>
8		<b>PC interface, serial (D-Sub connection socket, 9-pole)</b>
9		<b>Connecting nipple G<math>\frac{1}{4}</math>, shielding gas connection</b>
10		<b>Key button, automatic cutout</b> Wire feed motor supply voltage fuse press to reset a triggered fuse
<b>▼ Retrofitting option ▼</b>		
11		<b>19-pole mechanised welding interface (analogue)</b> - See 5.14.1 Automation interface chapter
<b>▲ Retrofitting option ▲</b>		
12		<b>7-pole connection socket (digital)</b> For connecting digital accessory components (documentation interface, robot interface or remote control, etc.).
13		<b>Mains connection cable</b> - See 5.7 Mains connection chapter

## 4.3 Inside view

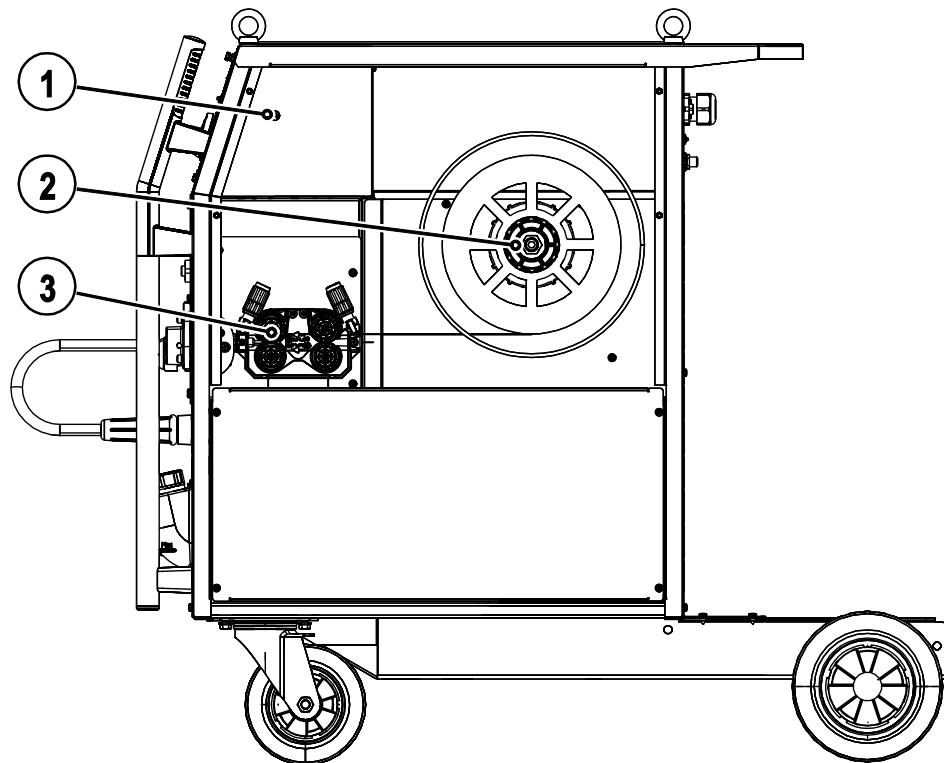



Figure 4-3

Item	Symbol	Description
1		<b>Welding torch function changeover switch</b> (special welding torch required) Changing over programs or JOBs Infinite adjustment of welding performance.
2		<b>Wire spool holder</b>
3		<b>Wire feed unit</b>

## 4.4 Machine control – Operating elements

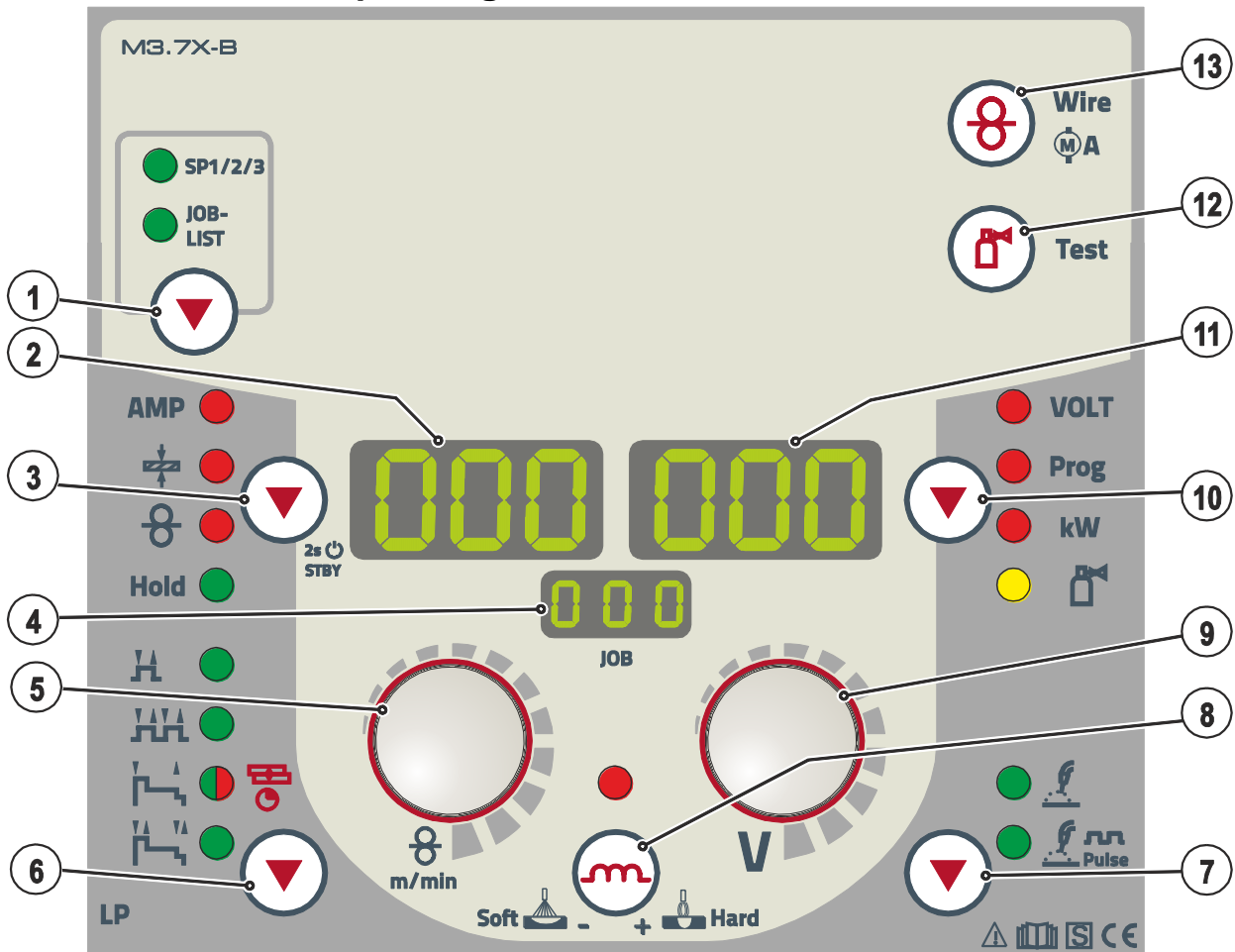

Figure 4-4

Item	Symbol	Description
1		<b>Push-button, welding task selection (JOB)</b> SP1/2/3 Special JOBS (Phoenix Expert only). Pressing the push-button longer: special JOB selection. Pressing the push-button briefly: switching between special JOBS. JOB-LIST Select the welding task using the welding task list (JOB-LIST) (not applicable for Phoenix Expert). The list can be found inside the protective cap of the wire feed mechanism and in the appendix to these operating instructions.
2		<b>Display, left</b> Welding current, material thickness, wire speed, hold values
3		<b>Push-button, parameter selection left/power-saving mode</b> AMP Welding current Material thickness Wire feed speed Hold After welding, the values used last are shown from the main program. The signal light is illuminated. STBY Press for 2 s to put machine into power-saving mode. To reactivate, activate one of the operating elements.
4		<b>Display, JOB</b> Shows the currently selected welding task (JOB number). Phoenix Expert machines will display the special JOB selected (SP1, 2 or 3), if applicable.



Item	Symbol	Description
5		<b>Rotary knob, welding parameter setting</b> <ul style="list-style-type: none"> <li>Setting the welding task (JOB). With machines of the Phoenix Expert series, welding tasks are selected at the power source control.</li> <li>Setting the welding power and other welding parameters.</li> </ul>
6		<b>Select operating mode button</b> <ul style="list-style-type: none"> <li>H Non-latched</li> <li>HH Latched</li> <li>T Signal light lights up in green: Special non-latched</li> <li>T with red circle Signal light lights up in red: MIG spot welding</li> <li>T with double underline Special latched</li> </ul>
7		<b>Welding type push-button</b> <ul style="list-style-type: none"> <li>Standard arc welding</li> <li>Pulse Pulsed arc welding</li> </ul>
8		<b>Push-button, throttling effect (arc dynamics)</b> <ul style="list-style-type: none"> <li>+ Hard Arc is harder and more narrow</li> <li>Soft - Arc is softer and wider</li> </ul>
9		<b>Arc length correction/selection of welding program, rotary dial</b> <ul style="list-style-type: none"> <li>Correction of the arc length from -9.9 V to +9.9 V.</li> <li>Selection of welding programs 0 to 15 (not possible if accessory components, such as program torches, are connected).</li> </ul>
10		<b>Button, Parameter selection (right)</b> <ul style="list-style-type: none"> <li>VOLT Welding voltage</li> <li>Prog Program number</li> <li>kW Welding performance display</li> <li>Gas flow quantity (optional)</li> </ul>
11		<b>Display, right</b> Welding voltage, program number, motor current (wire feed mechanism)
12		<b>Gas test / rinse button</b> <ul style="list-style-type: none"> <li>Gas test: For setting the shielding gas quantity</li> <li>Rinse: For rinsing longer hose packages</li> </ul> - See 5.8 Shielding gas supply (shielding gas cylinder for welding machine) chapter
13		<b>Push-button, wire inching/motor current (wire feed mechanism)</b> - See 5.10.2.4 Inching the wire electrode chapter

## 5 Design and function

### 5.1 General

#### WARNING



##### **Risk of injury from electric shock!**

**Contact with live parts, e.g. welding current sockets, is potentially fatal!**

- Follow safety instructions on the opening pages of the operating instructions.
- Commissioning may only be carried out by persons who have the relevant expertise of working with arc welding machines!
- Connection and welding leads (e.g. electrode holder, welding torch, workpiece lead, interfaces) may only be connected when the machine is switched off!

#### CAUTION



##### **Insulate the arc welder from welding voltage!**

**Not all active parts of the welding current circuit can be shielded from direct contact. To avoid any associated risks it is vital for the welder to adhere to the relevant safety regulations. Even low voltages can cause a shock and lead to accidents.**

- Wear dry and undamaged protective clothing (shoes with rubber soles/welder's gloves made from leather without any studs or braces)!
- Avoid direct contact with non-insulated connection sockets or connectors!
- Always place torches and electrode holders on an insulated surface!



##### **Risk of burns on the welding current connection!**

**If the welding current connections are not locked, connections and leads heat up and can cause burns, if touched!**

- Check the welding current connections every day and lock by turning in clockwise direction, if necessary.



##### **Risk of injury due to moving parts!**

**The wire feeders are equipped with moving parts, which can trap hands, hair, clothing or tools and thus injure persons!**

- Do not reach into rotating or moving parts or drive components!
- Keep casing covers or protective caps closed during operation!



##### **Risk of injury due to welding wire escaping in an unpredictable manner!**

**Welding wire can be conveyed at very high speeds and, if conveyed incorrectly, may escape in an uncontrolled manner and injure persons!**

- Before mains connection, set up the complete wire guide system from the wire spool to the welding torch!
- Remove the pressure rollers from the wire feeder if no welding torch is fitted!
- Check wire guide at regular intervals!
- Keep all casing covers or protective caps closed during operation!



##### **Risk from electrical current!**

**If welding is carried out alternately using different methods and if a welding torch and an electrode holder remain connected to the machine, the open-circuit/welding voltage is applied simultaneously on all cables.**

- The torch and the electrode holder should therefore always be placed on an insulated surface before starting work and during breaks.

**CAUTION****Damage due to incorrect connection!**

**Accessory components and the power source itself can be damaged by incorrect connection!**

- Only insert and lock accessory components into the relevant connection socket when the machine is switched off.
- Comprehensive descriptions can be found in the operating instructions for the relevant accessory components.
- Accessory components are detected automatically after the power source is switched on.

**Using protective dust caps!**

**Protective dust caps protect the connection sockets and therefore the machine against dirt and damage.**

- The protective dust cap must be fitted if there is no accessory component being operated on that connection.
- The cap must be replaced if faulty or if lost!

## 5.2 Installation

**CAUTION****Installation site!**

**The machine must not be operated in the open air and must only be set up and operated on a suitable, stable and level base!**

- The operator must ensure that the ground is non-slip and level, and provide sufficient lighting for the place of work.
- Safe operation of the machine must be guaranteed at all times.

## 5.3 Machine cooling

To obtain an optimal duty cycle from the power components, the following precautions should be observed:

- Ensure that the working area is adequately ventilated.
- Do not obstruct the air inlets and outlets of the machine.
- Do not allow metal parts, dust or other objects to get into the machine.

## 5.4 Workpiece lead, general

**CAUTION****Risk of burns due to incorrect connection of the workpiece lead!**

**Paint, rust and dirt on the connection restrict the power flow and may lead to stray welding currents.**

**Stray welding currents may cause fires and injuries!**

- Clean the connections!
- Fix the workpiece lead securely!
- Do not use structural parts of the workpiece as a return lead for the welding current!
- Take care to ensure faultless power connections!

## 5.5 Notes on the installation of welding current leads

- Incorrectly installed welding current leads can cause faults in the arc (flickering).**
- Lay the workpiece lead and hose package of power sources without HF igniter (MIG/MAG) for as long and as close as possible in parallel.**
- Lay the workpiece lead and hose package of power sources with HF igniter (TIG) for as long as possible in parallel with a distance of 20 cm to avoid HF sparkover.**
- Always keep a distance of at least 20 cm to leads of other power sources to avoid interferences**
- Always keep leads as short as possible! For optimum welding results max. 30 m (welding lead + intermediate hose package + torch lead).**

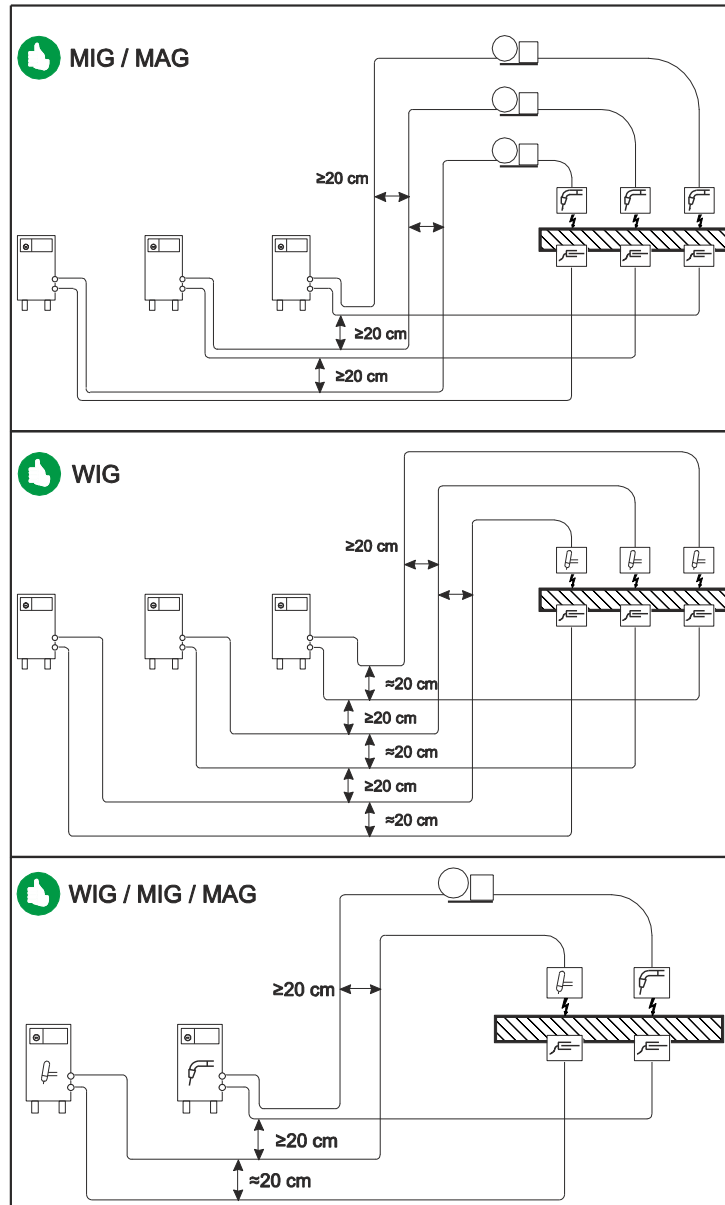

Figure 5-1

**Use an individual welding lead to the workpiece for each welding machine!**

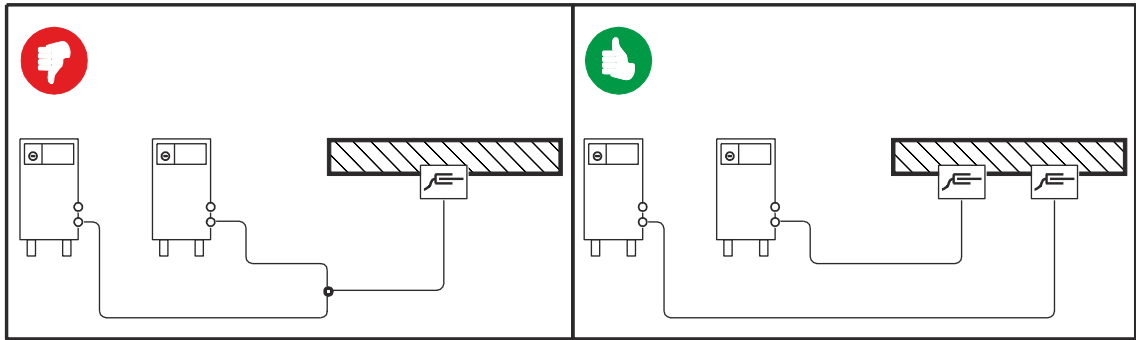

Figure 5-2

**Fully unroll welding current leads, torch hose packages and intermediate hose packages. Avoid loops!**

**Always keep leads as short as possible!**

**Lay any excess cable lengths in meanders.**

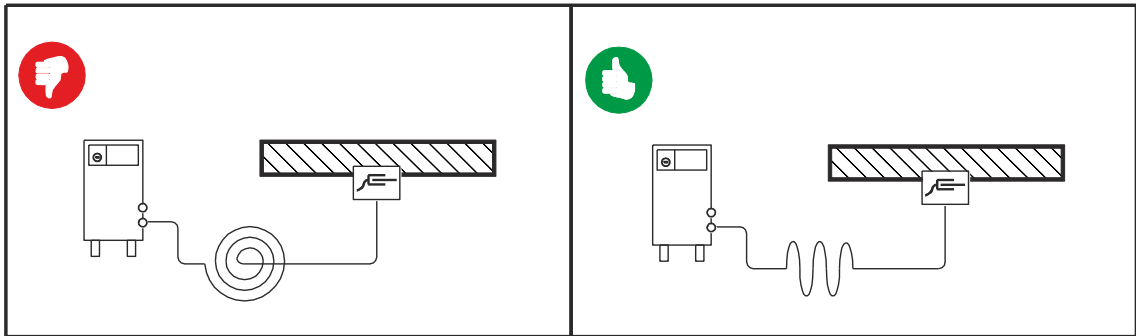

Figure 5-3

## 5.6 Welding torch cooling system

### CAUTION



#### Coolant mixtures!

Mixtures with other liquids or the use of unsuitable coolants result in material damage and renders the manufacturer's warranty void!

- Only use the coolant described in this manual (overview of coolants).
- Do not mix different coolants.
- When changing the coolant, the entire volume of liquid must be changed.



#### Insufficient frost protection in the welding torch coolant!

Depending on the ambient conditions, different liquids are used for cooling the welding torch - See 5.6.1 List of coolants chapter.

Coolants with frost protection (KF 37E or KF 23E) must be checked regularly to ensure that the frost protection is adequate to prevent damage to the machine or the accessory components.

- The coolant must be checked for adequate frost protection with the TYP 1 frost protection tester .
- Replace coolant as necessary if frost protection is inadequate!



*The disposal of coolant must be carried out according to official regulations and observing the relevant safety data sheets (German waste code number: 70104)!*

*Coolant must not be disposed of together with household waste.*

*Coolant must not be discharged into the sewerage system.*

*Recommended cleaning agent: water, if necessary with cleaning agent added.*

### 5.6.1 List of coolants

The following coolants may be used - See 9 Accessories chapter:

Coolant	Temperature range
KF 23E (Standard)	-10 °C to +40 °C
KF 37E	-20 °C to +10 °C

### 5.6.2 Maximal hose package length

	Pump 3.5 bar	Pump 4.5 bar
Machines with or without separate wire feeder	30 m	60 m
Compact machines with additional intermediate drive (example. miniDrive)	20 m	30 m
Machines with separate wire feeder and additional intermediate drive (example: miniDrive)	20 m	60 m

Data as a rule refer to the entire hose package length

including welding torch. The pump output is shown on the type plate (parameter: Pmax).

Pump 3.5 bar: Pmax = 0.35 MPa (3.5 bar)

Pump 4.5 bar: Pmax = 0.45 MPa (4.5 bar)

### 5.6.3 Adding coolant

The unit is supplied ex works with a minimum level of coolant.

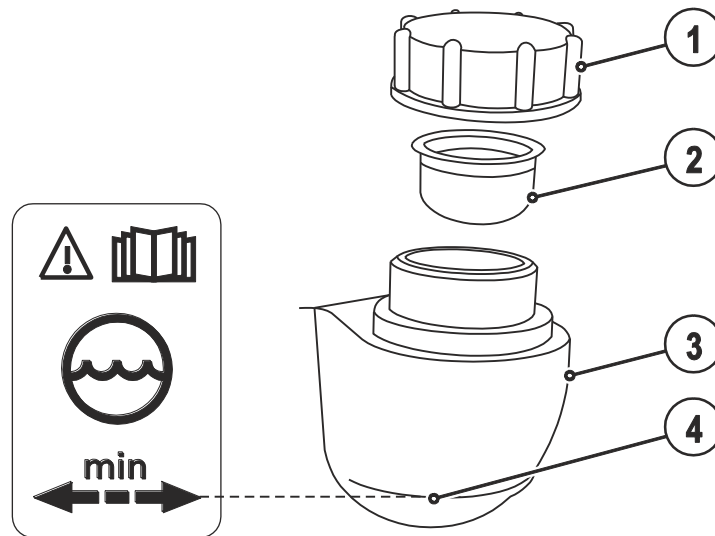



Figure 5-4

Item	Symbol	Description
1		Coolant tank cap
2		Coolant filter sieve
3		Coolant tank
4		"Min" mark Minimum coolant level

- Unscrew and remove the coolant tank sealing cover.
- Check filter sieve insert for dirt, clean if necessary and reinsert into position.
- Top up coolant to the filter sieve insert, close sealing cover again.

 **After the initial filling, wait for at least one minute when the machine is switched on so that the hose package is filled with coolant completely and without bubbles. With frequent changes of torch and during the initial filling process, the cooling unit tank should be topped up as necessary.**

 **The level of coolant must never fall below the "min" mark.**

 **If there is less coolant in the coolant tank than the minimum required you may need to vent the coolant circuit. In this case the welding machine will automatically shut down the coolant pump and signal an error, "- See 7 Rectifying faults chapter".**

## 5.7 Mains connection

### ⚠ DANGER



**Hazard caused by improper mains connection!**

**An improper mains connection can cause injuries or damage property!**

- Only use machine with a plug socket that has a correctly fitted protective conductor.
- If a mains plug must be fitted, this may only be carried out by an electrician in accordance with the relevant national provisions or regulations!
- Mains plug, socket and lead must be checked regularly by an electrician!
- When operating the generator always ensure it is earthed as stated in the operating instructions. The resulting network has to be suitable for operating devices according to protection class 1.

### 5.7.1 Mains configuration



*The machine may be connected to:*

- a three-phase system with four conductors and an earthed neutral conductor
- a three-phase system with three conductors of which any one can be earthed, e.g. the outer conductor

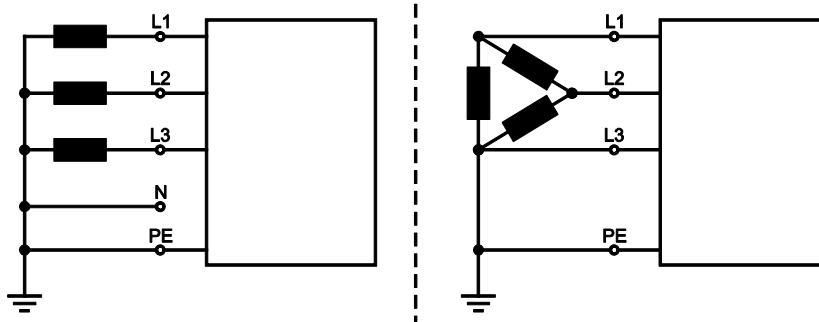

Figure 5-5

#### Legend

Item	Designation	Colour code
L1	Outer conductor 1	brown
L2	Outer conductor 2	black
L3	Outer conductor 3	grey
N	Neutral conductor	blue
PE	Protective conductor	green-yellow

### CAUTION



**Operating voltage - mains voltage!**

**The operating voltage shown on the rating plate must be consistent with the mains voltage, in order to avoid damage to the machine!**

- - See 8 Technical data chapter!

- Insert mains plug of the switched-off machine into the appropriate socket.



### 5.8 Shielding gas supply (shielding gas cylinder for welding machine)

**⚠ WARNING**

**Risk of injury due to improper handling of shielding gas cylinders! Improper handling and insufficient securing of shielding gas cylinders can cause serious injuries!**

- Secure shielding gas cylinders using the standard fastening elements on the unit (chain/belt)!
- The fastening elements must tightly enclose the shielding gas cylinder!
- Attach the fastening elements within the upper half of the shielding gas cylinder!
- Do not attach any element to the shielding gas cylinder valve!
- Observe the instructions from the gas manufacturer and any relevant regulations concerning the use of compressed air!
- Avoid heating the shielding gas cylinder!

**CAUTION**

**Faults in the shielding gas supply.**  
**An unhindered shielding gas supply from the shielding gas cylinder to the welding torch is a fundamental requirement for optimum welding results. In addition, a blocked shielding gas supply may result in the welding torch being destroyed.**

- Always re-fit the yellow protective cap when not using the shielding gas connection.
- All shielding gas connections must be gas tight.

**👉 Before connecting the pressure regulator to the gas cylinder, open the cylinder valve briefly to expel any dirt.**

- Place the shielding gas cylinder into the relevant cylinder bracket.
- Secure the shielding gas cylinder using a securing chain.

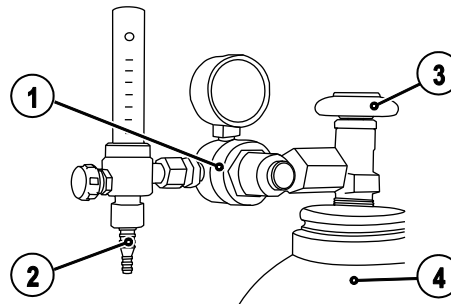



Figure 5-6

Item	Symbol	Description
1		Pressure regulator
2		Shielding gas cylinder
3		Output side of the pressure regulator
4		Cylinder valve



- Tighten the pressure regulator screw connection on the gas bottle valve to be gas-tight.
- Screw gas hose connection crown nut onto the output side of the pressure regulator.
- Fasten the gas hose to the shielding gas connecting nipple at the back of the machine using the crown nut.

## 5.8.1 Gas test

- Slowly open the gas cylinder valve.
- Open the pressure regulator.
- Switch on the power source at the main switch.
- Initiate gas test function on the machine control.
- Set the relevant gas quantity for the application on the pressure regulator.
- The gas test is triggered on the machine control by pressing the  button briefly.

Shielding gas flows for around 25 seconds or until the button is pressed again.

## 5.8.2 Rinse hose package function

Operating Element	Action	Result
	 5 s	Select rinse hose package. Shielding gas flows continuously until the Gas Test button is pressed again.

### 5.8.2.1 Setting the shielding gas quantity

Welding process	Recommended shielding gas quantity
MAG welding	Wire diameter x 11.5 = l/min
MIG brazing	Wire diameter x 11.5 = l/min
MIG welding (aluminium)	Wire diameter x 13.5 = l/min (100 % argon)
TIG	Gas nozzle diameter in mm corresponds to l/min gas throughput

#### Helium-rich gas mixtures require a higher gas volume!

The table below can be used to correct the gas volume calculated where necessary:

Shielding gas	Factor
75% Ar/25% He	1.14
50% Ar/50% He	1.35
25% Ar/75% He	1.75
100% He	3.16



#### **Incorrect shielding gas setting!**

- **If the shielding gas setting is too low or too high, this can introduce air to the weld pool and may cause pores to form.**
- **Adjust the shielding gas quantity to suit the welding task!**

## 5.9 Welding data display

To the left and right of the control displays are the "Parameter selection" buttons (◻). They are used to select welding parameters to be displayed.

Each press of the button advances the display to the next parameter (LEDs next to the button indicate the selection). After the last parameter is reached, the system starts again from the beginning.

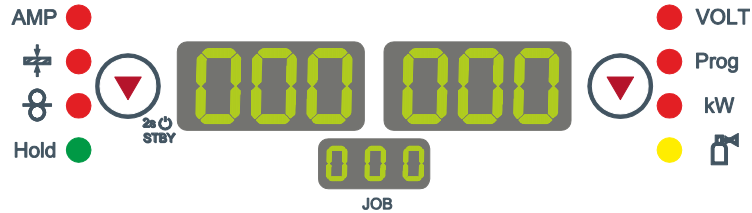

Figure 5-7

The display shows:

- Nominal values (before welding)
- Actual values (during welding)
- Hold values (after welding)

Parameter	Nominal values	Actual values	Hold values
Welding current	<input checked="" type="checkbox"/>	<input checked="" type="checkbox"/>	<input checked="" type="checkbox"/>
Material thickness	<input checked="" type="checkbox"/>	<input type="checkbox"/>	<input type="checkbox"/>
Wire feed speed	<input checked="" type="checkbox"/>	<input checked="" type="checkbox"/>	<input checked="" type="checkbox"/>
Welding voltage	<input checked="" type="checkbox"/>	<input checked="" type="checkbox"/>	<input checked="" type="checkbox"/>
Welding performance	<input type="checkbox"/>	<input checked="" type="checkbox"/>	<input checked="" type="checkbox"/>

When settings are changed (e.g. wire feed speed) the display immediately switches to nominal value setting.

## 5.10 MIG/MAG welding

### 5.10.1 Welding torch and workpiece line connection

#### CAUTION



**Equipment damage due to improperly connected coolant pipes!**

**If the coolant pipes are not properly connected or a gas-cooled welding torch is used, the coolant circuit is interrupted and equipment damage can occur.**

- Connect all coolant pipes correctly!
- Completely unroll the hose package and the torch hose package!
- Observe maximal hose package length - See 5.6 Welding torch cooling system chapter.
- When using a gas-cooled welding torch, use a hose bridge to establish the coolant circuit - See 9 Accessories chapter.



**On delivery, the Euro torch connector is fitted with a capillary tube for welding torches with a steel liner. Conversion is necessary if a welding torch with a liner is used!**

- **Operate welding torches with a liner > with a guide tube.**
- **Operate welding torches with a steel liner > with a capillary tube.**

**Depending on the wire electrode diameter or type, either a steel liner or liner with the correct inner diameter must be inserted in the torch!**

Recommendation:

- Use a steel liner when welding hard, unalloyed wire electrodes (steel).
- Use a chrome nickel liner when welding hard, high-alloy wire electrodes (CrNi).
- Use a liner to weld or braze soft wire electrodes, high-alloy wire electrodes or aluminium materials.

**Preparation for connecting welding torches with a liner:**

- Push forward the capillary tube on the wire feed side in the direction of the Euro torch connector and remove it there.
- Insert the liner guide tube from the Euro torch connector side.
- Carefully insert the welding torch connector with as yet too long a liner into the Euro torch connector and secure with a crown nut.
- Cut off the liner with a liner cutter just before the wire feed roller.
- Loosen the welding torch connector and remove.
- Carefully chamfer the cut off end of the liner with a liner sharpener and sharpen.

**Preparation for connecting welding torches with a spiral guide:**

- Check that the capillary tube is correctly positioned in relation to the central connector!

**Some wire electrodes (e.g. self-shielding cored wire) are welded using negative polarity. In this case, the welding current lead should be connected to the "-" welding current socket, and the workpiece lead should be connected to the "+" welding current socket. Observe the information from the electrode manufacturer!**

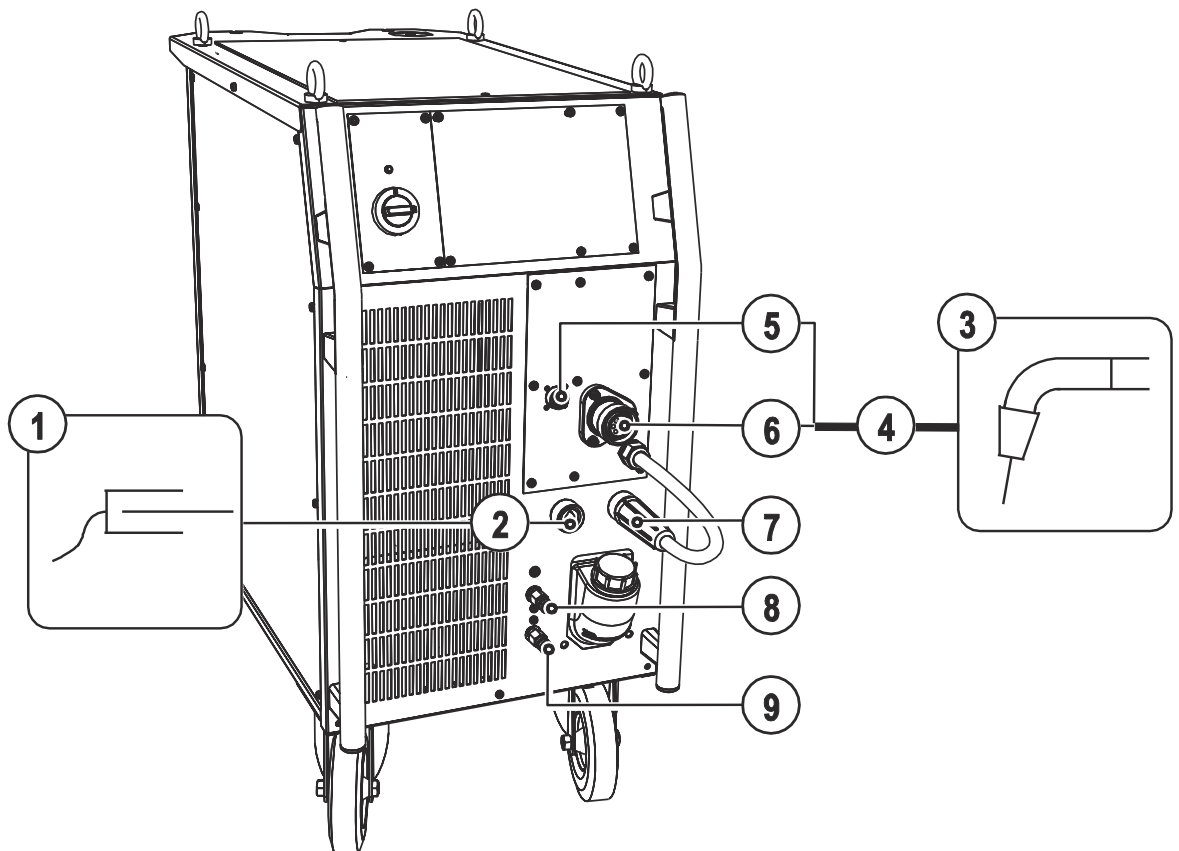

Figure 5-8

Item	Symbol	Description
1		<b>Workpiece</b>
2		<b>"-" welding current connection socket</b> • MIG/MAG welding: Workpiece connection
3		<b>Welding torch</b>
4		<b>Welding torch hose package</b>
5		<b>19-pole connection socket (analogue)</b> For connecting analogue accessory components (remote control, welding torch control lead, etc.)
6		<b>Welding torch connection (Euro or Dinse torch connector)</b> Welding current, shielding gas and torch trigger integrated
7		<b>Welding current cable, polarity selection</b> Welding current to central connection/torch. Permits polarity selection for MIG/MAG welding. • Standard applications > Connection for "+" welding current connection socket
8		<b>Quick connect coupling (red)</b> coolant return
9		<b>Quick connect coupling (blue)</b> coolant supply

- Insert the central plug for the welding torch into the central connector and screw together with crown nut.
- Insert the plug on the workpiece lead into the "-" welding current connection socket and lock.
- Welding current lead, insert polarity selection into the "+" welding current connection socket and lock.
- Insert the welding torch control cable into the 19-pole connection socket and lock (MIG/MAG torches with additional control cables only).

**Where applicable:**

- Lock connecting nipples of the cooling water tubes into the corresponding quick connect couplings:  
Return line red to quick connect coupling, red (coolant return) and  
supply line blue to quick connect coupling, blue (coolant supply).

## 5.10.2 Wire feed

### 5.10.2.1 Open the protective flap of the wire feeder

#### CAUTION



To perform the following steps, the protective flap of the wire feeder needs to be opened. Make sure to close the protective flap again before starting to work.

- Unlock and open protective flap.

### 5.10.2.2 Inserting the wire spool

#### CAUTION



**Risk of injury due to incorrectly secured wire spool.**

If the wire spool is not secured properly, it may come loose from the wire spool holder and fall to the ground, causing damage to the machine and injuries.

- Securely fasten the wire spool to the wire spool holder using the knurled nut.
- Before you start working, always check the wire spool is securely fastened.



**Standard D300 wire spool holder can be used. Adapters - See 9 Accessories chapter are required when using standardised basket coils (DIN 8559).**

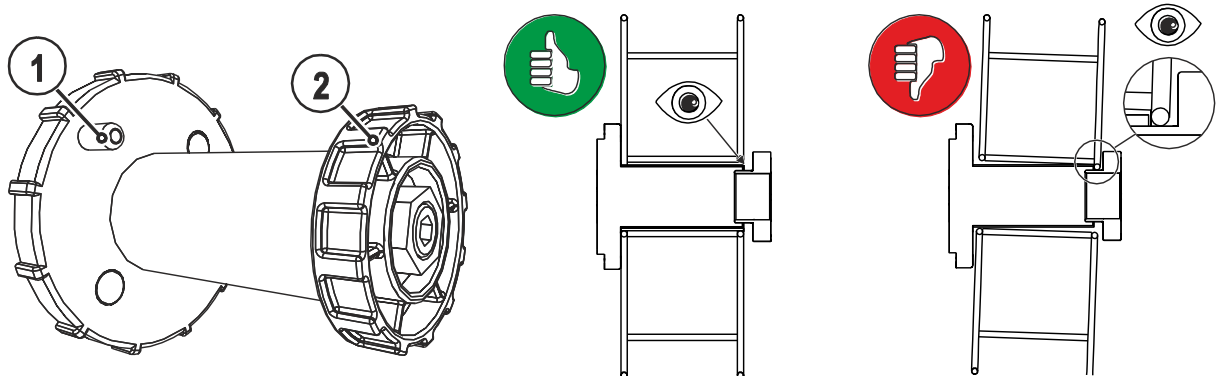

Figure 5-9

Item	Symbol	Description
1		<b>Carrier pin</b> For fixing the wire spool
2		<b>Knurled nut</b> For fixing the wire spool

- Loosen knurled nut from spool holder.
- Fix welding wire reel onto the spool holder so that the carrier pin locks into the spool bore.
- Fasten wire spool using knurled nut.

## 5.10.2.3 Changing the wire feed rollers

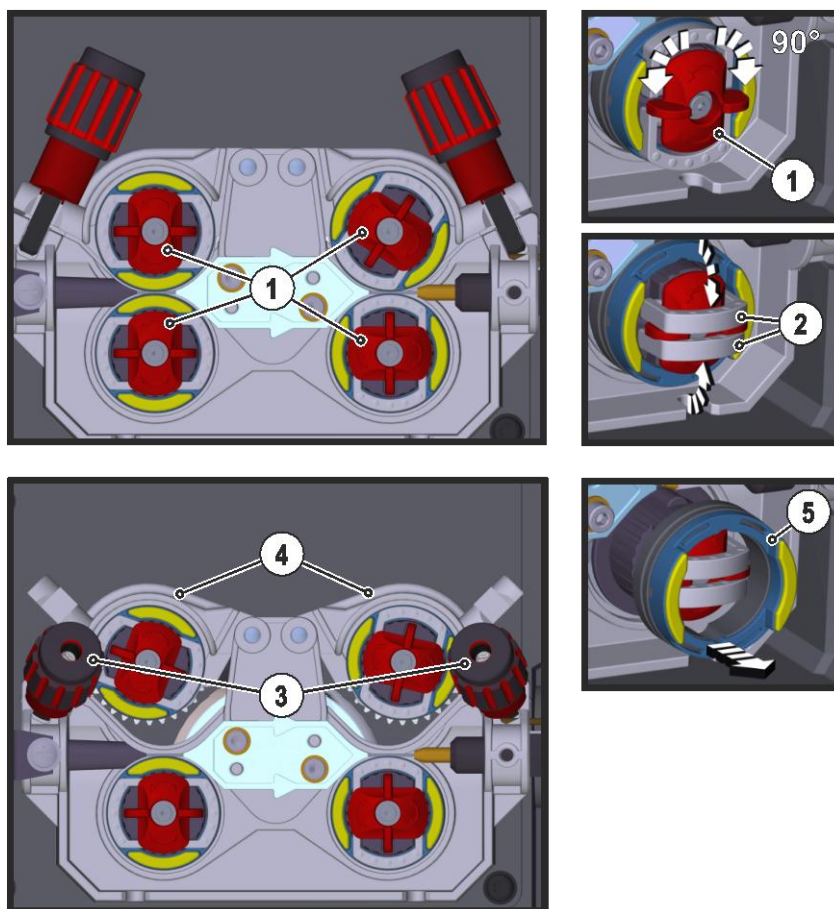

Figure 5-10

Item	Symbol	Description
1		<b>Tommy</b> The tommy is used to secure the closure brackets of the wire feed rollers.
2		<b>Closure bracket</b> The closure brackets are used to secure the wire feed rollers.
3		<b>Feed roll tensioner</b> Fixing the clamping unit and setting the pressure.
4		<b>Clamping unit</b>
5		<b>Wire feed roller</b> see the Wire feed roller overview table

- Rotate the tommy by 90° clockwise or anti-clockwise (tommy locks into place).
- Fold the closure brackets outwards by 90°.
- Unfasten pressure units and fold out (clamping units and pressure rollers will automatically flip upwards).
- Remove the wire feed rollers from the roller support.
- Select new wire feed rollers according to the Wire feed roller overview table and reassemble the wire feed mechanism in reverse order.





**Unsatisfactory welding results due to faulty wire feeding!**

The wire feed rollers must be suitable for the diameter of the wire and the material. The wire feed rollers are colour-coded to facilitate distinction (see the Wire feed roller overview table).

Wire feed roller overview table

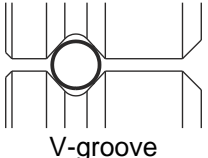
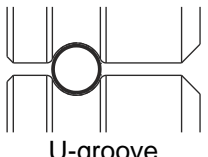
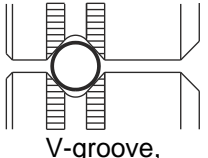
Material	Diameter		Colour code			Groove form
	Ø mm	Ø inch				
Steel Stainless steel steel Brazing	0.6	.023	monochrome	light pink	-	 V-groove
	0.8	.030		white		
	0.9/1.0	.035/.040		blue		
	1.2	.045		red		
	1.4	.052		green		
	1.6	.060		black		
	2.0	.080		grey		
	2.4	.095		brown		
	2.8	.110		Light green		
	3.2	.125		purple		
Aluminium	0.8	.030	bichrome	white	yellow	 U-groove
	0.9/1.0	.035/.040		blue		
	1.2	.045		red		
	1.6	.060		black		
	2.0	.080		grey		
	2.4	.095		brown		
	2.8	.110		Light green		
	3.2	.125		purple		
Flux cored wire	0.8	.030	bichrome	white	orange	 V-groove, knurled
	0.9	.035		blue		
	1.0	.040				
	1.2	.045		red		
	1.4	.052		green		
	1.6	.060		black		
	2.0	.080		grey		
	2.4	.095		brown		



- See 10 Replaceable parts chapter

## 5.10.2.4 Inching the wire electrode

### CAUTION



#### **Risk of injury due to moving parts!**

**The wire feeders are equipped with moving parts, which can trap hands, hair, clothing or tools and thus injure persons!**

- Do not reach into rotating or moving parts or drive components!
- Keep casing covers or protective caps closed during operation!



#### **Risk of injury due to welding wire escaping in an unpredictable manner!**

**Welding wire can be conveyed at very high speeds and, if conveyed incorrectly, may escape in an uncontrolled manner and injure persons!**

- Before mains connection, set up the complete wire guide system from the wire spool to the welding torch!
- Remove the pressure rollers from the wire feeder if no welding torch is fitted!
- Check wire guide at regular intervals!
- Keep all casing covers or protective caps closed during operation!



#### **Risk of injury due to welding wire escaping from the welding torch!**

**The welding wire can escape from the welding torch at high speed and cause bodily injury including injuries to the face and eyes!**

- Never direct the welding torch towards your own body or towards other persons!

### CAUTION



#### **Extensive wear due to incorrect contact pressure!**

**Incorrect contact pressure will cause extensive wear of the wire feed rollers!**

- With the adjusting nuts of the pressure units set the contact pressure so that the wire electrode is conveyed but will still slip through if the wire spool jams.
- Set the contact pressure of the front rollers (in wire feed direction) to a higher value!



***The inching speed is infinitely adjustable by simultaneously pressing the wire inching push-button and turning the wire speed rotary knob. The left display shows the wire feed speed selected, the right display shows the current motor current of the wire feed mechanism.***

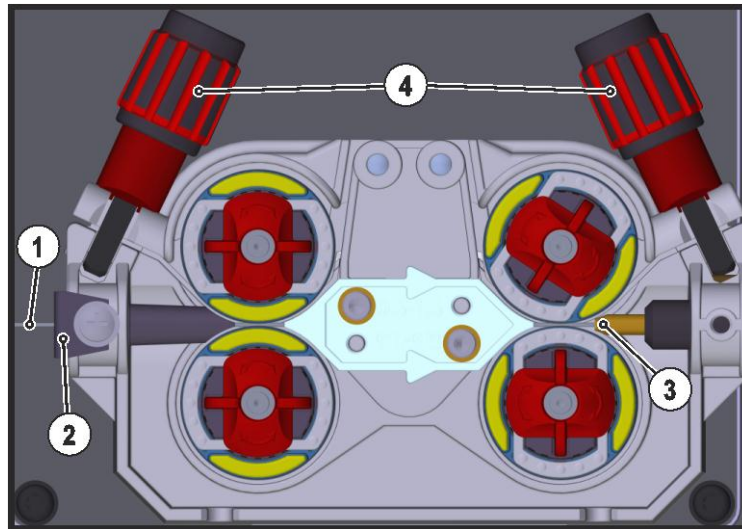

Figure 5-11

Item	Symbol	Description
1		Welding wire
2		Wire feed nipple
3		Guide tube
4		Adjusting nut

- Extend and lay out the torch hose package.
- Carefully unwind the welding wire from the wire spool and insert through the wire feed nipples up to the wire feed rollers.
- Press the inching push-button (the drive catches the welding wire and automatically guides it to the welding torch outlet).



**A prerequisite for the automatic inching process is the correct preparation of the wire guide, especially in the capillary and wire guide tube area .**

- The contact pressure has to be adjusted separately for each side (wire inlet/outlet) at the feed roll tensioner setting nuts depending on the welding consumable used. A table with the setting values can be found on a sticker near the wire drive.

### Version 1: left hand mounting

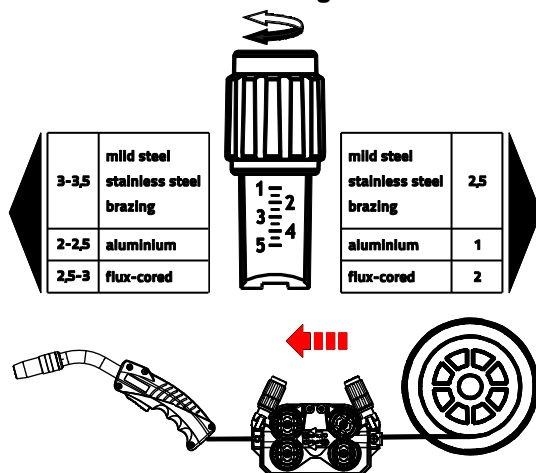

### Version 2: right hand mounting

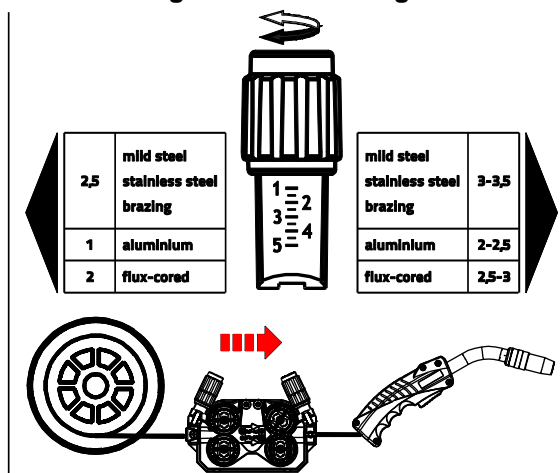

Figure 5-12

### Automatic inching stop

Touch the welding torch against the workpiece during inching. Inching of the welding wire will stop as soon it touches the workpiece.

## 5.10.2.5 Spool brake setting

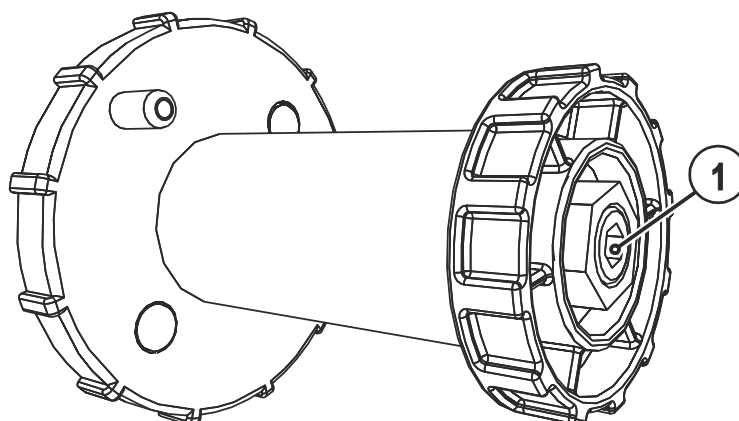

Figure 5-13

Item	Symbol	Description
1		<b>Allen screw</b> Securing the wire spool retainer and adjustment of the spool brake

- Tighten the Allen screw (8 mm) in the clockwise direction to increase the braking effect.



***Tighten the spool brake until the wire spool no longer turns when the wire feed motor stops but without it jamming during operation!***

### 5.10.3 Definition of MIG/MAG welding tasks

This machine series offers user-friendly operation and a multitude of features.

- Various welding tasks (JOBS) consisting of welding procedure, material type, wire diameter and shielding gas type have been predefined .
- The system calculates the required process parameters depending on the operating point specified (one-dial operation via wire feed speed rotary transducer).
- You can adjust additional parameters in the control configuration menu or using the PC300.NET welding parameter software, if required.

- See 11.1 JOB-List chapter

Phoenix Expert machine series:

The welding task is set at the power source control; refer to the relevant system documentation.

If required, the predefined special welding tasks SP1 = JOB 129 / SP2 = JOB130 / SP3 = JOB 131 only can be selected at the wire feeder control. The special JOBS are selected by pressing the welding task selection push-button for a longer period. The special JOBS are switched by pressing the push-button briefly.

### 5.10.4 Welding task selection

#### 5.10.4.1 Basic welding parameters

alpha Q, Phoenix Progress, Taurus Synergic S:

Operating element	Action	Result
	1 x	JOB list selection Select JOB (welding task) based on JOB list. The JOB-List sticker can be found on the inside of the protective cap of the wire feed mechanism.
		Set JOB number. Wait 3 s until the setting has been applied.

Phoenix Expert:

Operating element	Action	Result
	2 s	Special JOB selection (SP1/2/3)
	1 x	Set special JOB number. SP1 = JOB 129 / SP2 = JOB130 / SP3 = JOB 131 Press the button for a longer period to exit the special JOBS.

**You can only change the JOB number when no welding current is flowing.**

#### 5.10.4.2 Operating mode

Operating element	Action	Result	Display
	n x	<b>Select operating mode</b> The LED displays the selected operating mode. H Non-latched operation HH Latched operation H with green dot Green Special non-latched mode H with red dot Red Spot operating mode H with red dot and circle Special latched mode	No change

## 5.10.4.3 Choke effect / dynamics

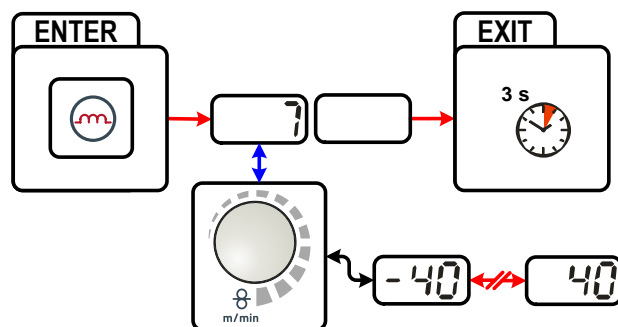

Figure 5-14

Display	Setting/selection
	<b>Dynamics setting</b> 40: Arc harder and narrower -40: Arc softer and wider

## 5.10.5 MIG/MAG operating point

The operating point (welding output) is specified using the principle of MIG/MAG one-dial operation, i.e. the user need only specify the operating point by setting the required wire speed, for example, and the digital system will calculate the optimum values for welding current and voltage (operating point).

The operating point setting can also be specified using the accessory components such as the remote control, welding torch, etc.

### 5.10.5.1 Selecting the display unit



Figure 5-15

The operating point (welding performance) can be displayed as the welding current, material thickness or wire speed.

Operating element	Action	Result
	n x	Switching the display between: <b>AMP</b> Welding current Material thickness Wire speed

#### Application example

Aluminium is to be welded.

- Material = AlMg,
- Gas = Ar 100%,
- Wire diameter = 1.2 mm

The correct wire speed is not known and is to be determined.

- Select the appropriate JOB (- See 11.1 JOB-List chapter)
- Switch to the material thickness display
- Set the material thickness as appropriate (e.g. 5 mm)
- Switch to the wire speed display

The resulting wire speed will be shown (e.g. 8.4 m/min).



### 5.10.5.2 Operating point setting using material thickness

Given below is a description of the setting work via the wire speed parameters as an example of operating point setting.

Operating element	Action	Result	Display
		Increase or reduce welding performance via the wire speed parameter. Display example: 10.5 m/min	

### 5.10.5.3 Arc length correction setting

The arc length can be corrected as follows.

Operating element	Action	Result	Display
		"Arc length correction" setting (Display example: -0.9V, setting range -9.9 V to +9.9 V)	

### 5.10.5.4 Accessory components for operating point setting

The operating point can also be set with various accessory components such as

- remote controls
- special torches
- PC software
- robot and industrial bus interfaces (optional interface for automated welding required – not possible for all machines in this series!)

For an overview of the accessory components See the operating instructions for the machine in question for a more detailed description of the individual machines and their functions.

- See 9 Accessories chapter



**5.10.6 forceArc / forceArc puls**

Heat-reduced, directionally stable and powerful arc with deep penetration for the upper power range.

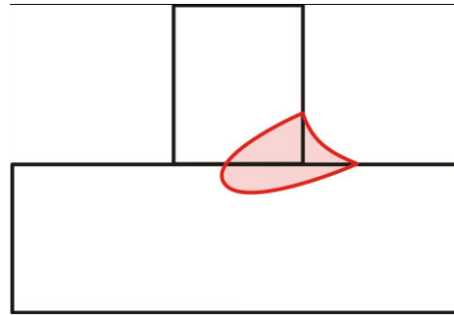

Figure 5-16

- Smaller included angle due to deep penetration and directionally stable arc
- Excellent root and sidewall fusion
- Secure welding also with very long stick-outs
- Reduced undercuts
- Un-, low- and high-alloyed steels as well as high-tensile fine-grained building steels
- Manual and automated applications

forceArc welding from:		Wire Ø (mm)							
		0.8		1		1.2		1.6	
Material	Gas	JOB	⊗	JOB	⊗	JOB	⊗	JOB	⊗
Steel	Ar 91–99%	190	17.0	254	12.0	255	9.5	256	7.0
	Ar 80–90%	189	17.0	179	12.0	180	9.5	181	6.0
CrNi	Ar 91–99%	-	-	251	12.0	252	12.0	253	6.0

You can make use of these properties after selecting the forceArc process- See 5.10.4 Welding task selection chapter.

**As with pulse arc welding, it is important to make sure of a good welding current connection.**

- Keep welding current cables as short as possible and ensure that cable cross-sections are adequate!
- Fully unroll welding current cables, torch hose packages and, if applicable, intermediate hose packages. Avoid loops!
- Use welding torches, preferably water-cooled, that are suitable for the higher power range.
- Use welding wire with adequate copper coating when welding steel. The wire spool should have layer spooling.

**Unstable arc!**

**Welding current cables that are not fully unrolled can cause faults in the arc (flickering).**

- **Fully unroll welding current cables, torch hose packages and, if applicable, intermediate hose packages. Avoid loops!**

## 5.10.7 rootArc/rootArc puls

Short arc with easy weld modelling capabilities for effortless gap bridging and positional welding.

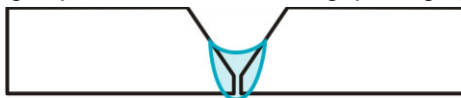

Figure 5-17

- Reduced spatter compared to standard short arc
- Good root formation and secure sidewall fusion
- Un-alloyed and low-alloy steels
- Manual and automated applications

rootArc welding up to:		Wire Ø (mm)											
		0.6		0.8		0.9		1		1.2		1.6	
Material	Gas	JOB	Ø	JOB	Ø	JOB	Ø	JOB	Ø	JOB	Ø	JOB	Ø
Steel	CO2	-	-	-	-	-	-	204	7.0	205	5.0	-	-
	Ar 80–90%	-	-	-	-	-	-	206	8.0	207	6.0	-	-



### Unstable arc!

*Welding current cables that are not fully unrolled can cause faults in the arc (flickering).*

- **Fully unroll welding current cables, torch hose packages and, if applicable, intermediate hose packages. Avoid loops!**

**5.10.8 MIG/MAG functional sequences / operating modes**
**5.10.9 Explanation of signs and functions**

Symbol	Meaning
	Press torch trigger
	Release torch trigger
	Tap torch trigger (press briefly and release)
	Shielding gas flowing
I	Welding output
	Wire electrode is being conveyed
	Wire creep
	Wire burn-back
	Gas pre-flows
	Gas post-flows
	Non-latched
	Special, non-latched
	Latched
	Special, latched
t	Time
<b>PSTART</b>	Ignition program
<b>PA</b>	Main program
<b>PB</b>	Reduced main program
<b>PEND</b>	End program
t2	Spot time

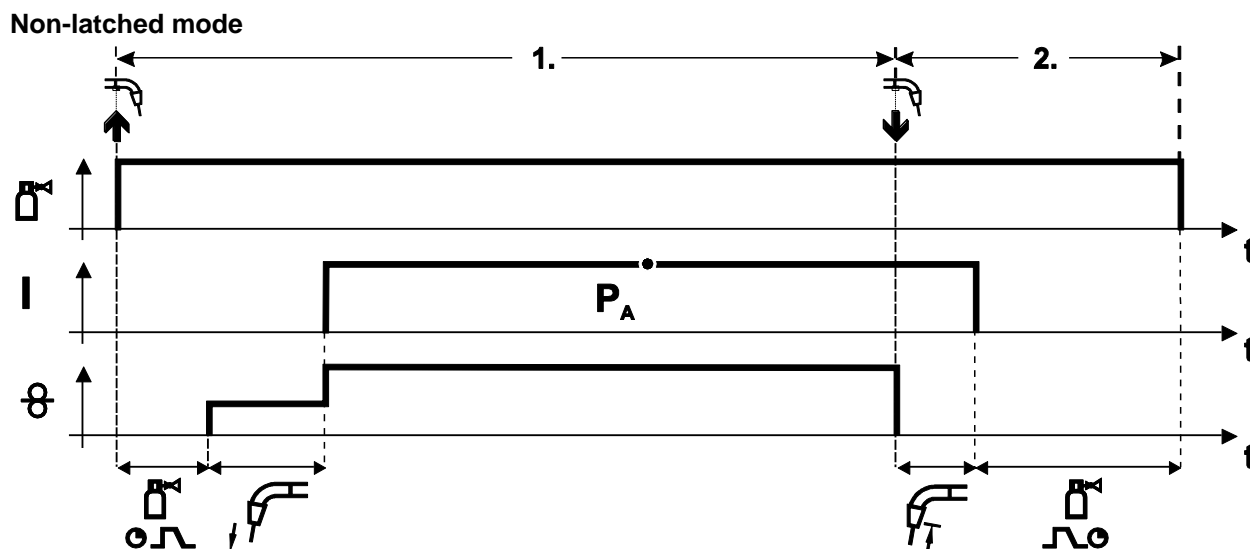

Figure 5-18

### Step 1

- Press and hold torch trigger.
- Shielding gas is expelled (gas pre-flows).
- Wire feed motor runs at “creep speed”.
- Arc ignites after the wire electrode makes contact with the workpiece; welding current flows.
- Change over to pre-selected wire speed.

### Step 2

- Release torch trigger.
- WF motor stops.
- Arc is extinguished after the preselected wire burn-back time expires.
- Gas post-flow time elapses.

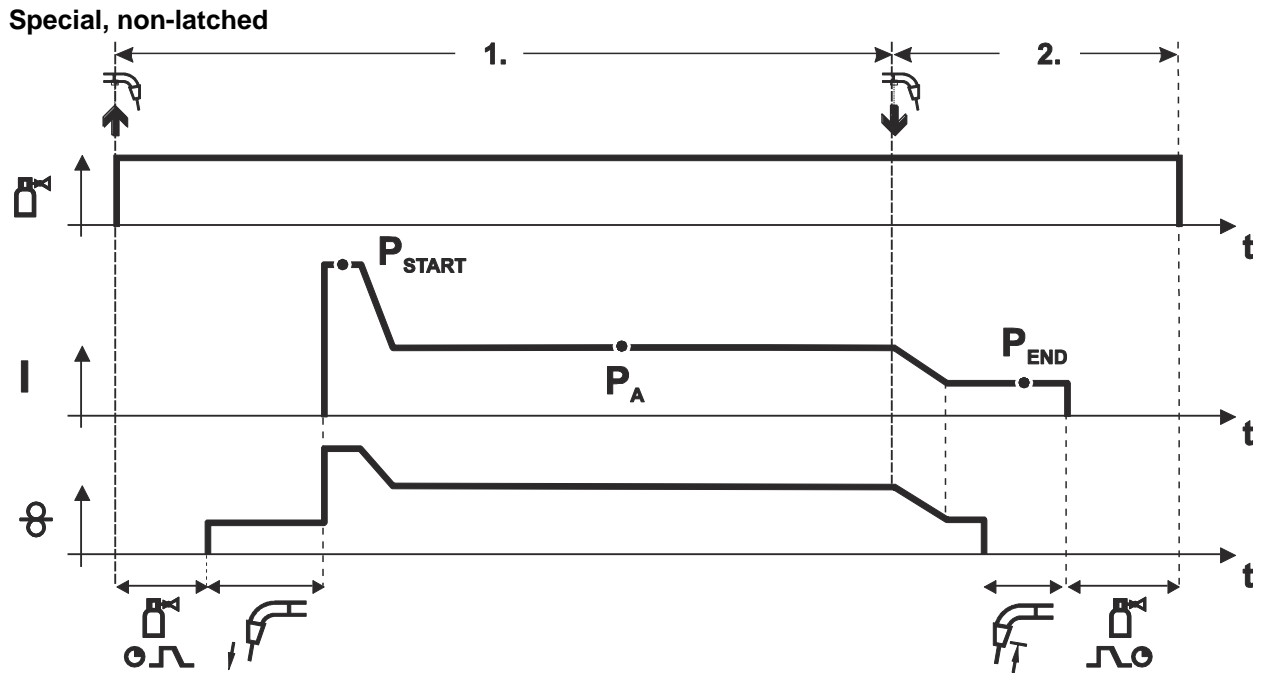

Figure 5-19

**Step 1**

- Press and hold torch trigger
- Shielding gas is expelled (gas pre-flows)
- Wire feed motor runs at “creep speed”.
- Arc ignites after the wire electrode makes contact with the workpiece, welding current is flowing (start program  $P_{START}$  for the time  $t_{start}$ )
- Slope to main program  $P_A$ .

**Step 2**

- Release torch trigger
- Slope to end program  $P_{END}$  for the time  $t_{end}$ .
- WF motor stops.
- Arc is extinguished after the preselected wire burn-back time expires.
- Gas post-flow time elapses.

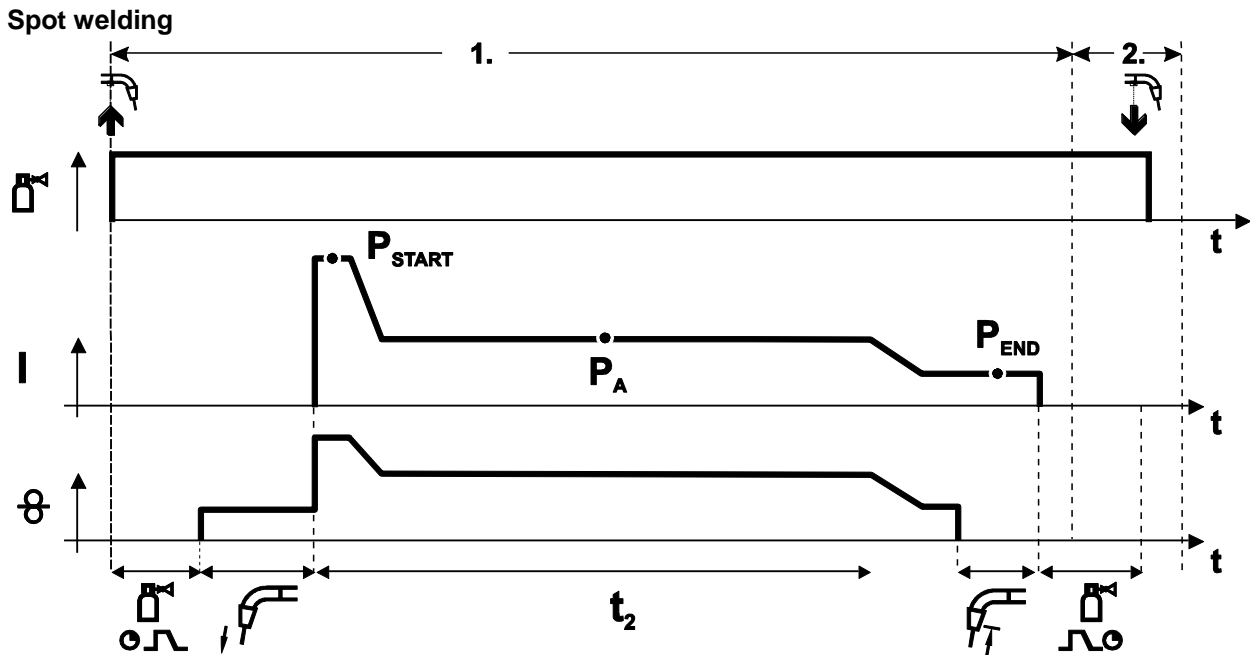

Figure 5-20

**The ignition time  $t_{start}$  must be added to the spot time  $t_2$ .**

### 1st cycle

- Press and hold torch trigger
- Shielding gas is expelled (gas pre-flows)
- Wire feed motor runs at "creep speed"
- Arc ignites after the wire electrode makes contact with the workpiece, welding current is flowing (start program  $P_{START}$ , spot time starts)
- Slope to main program  $P_A$
- After the set spot time elapses, slope goes to end program  $P_{END}$ .
- Wire feed motor stop welding.
- Arc is extinguished after the pre-selected wire burn-back time elapses
- Gas post-flow time elapses.

### 2nd cycle

- Release torch trigger

**Releasing the torch trigger (step 2) interrupts the welding process even if the spot time has not yet elapsed (slope to end program  $P_{END}$ ).**

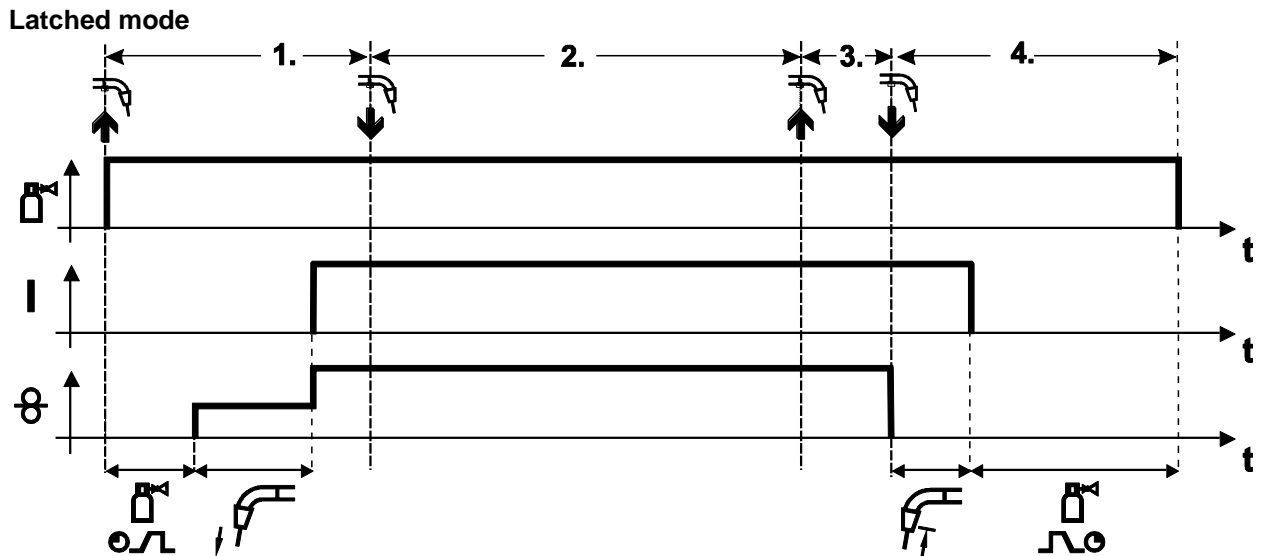

Figure 5-21

**Step 1**

- Press and hold torch trigger
- Shielding gas is expelled (gas pre-flows)
- Wire feed motor runs at "creep speed".
- Arc ignites after the wire electrode makes contact with the workpiece; welding current flows.
- Change over to pre-selected WF speed (main program P<sub>A</sub>).

**Step 2**

- Release torch trigger (no effect)

**Step 3**

- Press torch trigger (no effect)

**Step 4**

- Release torch trigger
- WF motor stops.
- Arc is extinguished after the preselected wire burn-back time expires.
- Gas post-flow time elapses.

## Latched special

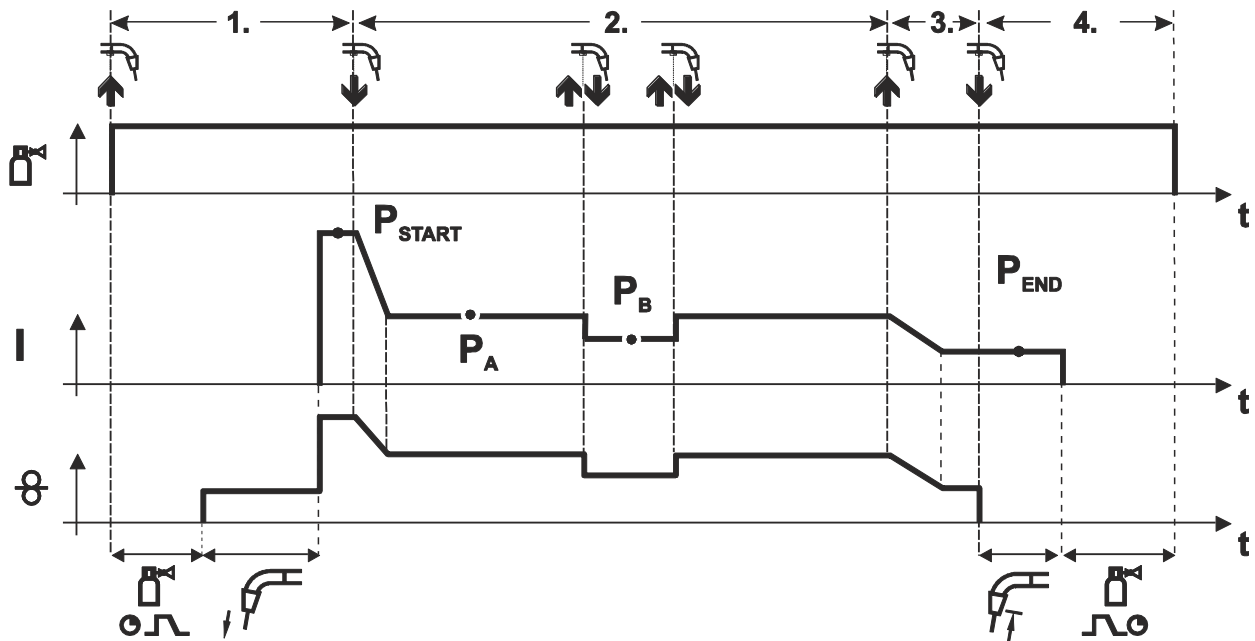

Figure 5-22

### Step 1

- Press and hold torch trigger
- Shielding gas is expelled (gas pre-flows)
- Wire feed motor runs at “creep speed”.
- Arc ignites after the wire electrode makes contact with the workpiece, welding current is flowing (start program  $P_{START}$ )

### Step 2

- Release torch trigger
- Slope to main program  $P_A$ .

The slope on main program  $P_A$  is given at the earliest after the set time  $t_{START}$  elapses and at the latest when the torch trigger is released.

Tapping<sup>1)</sup> can be used to change over to the reduced main program  $P_B$ .

Repeated tapping will switch back to the main program  $P_A$ .

### Step 3

- Press and hold torch trigger
- Slope to end program  $P_{END}$ .

### Step 4

- Release torch trigger
- WF motor stops.
- Arc is extinguished after the preselected wire burn-back time expires.
- Gas post-flow time elapses.



<sup>1)</sup> Prevent tapping (brief press and release within 0.3 seconds)

If the welding current is to be prevented from switching over to the reduced main program  $P_B$  by tapping, the parameter value for WF3 needs to be set to 100% ( $P_A = P_B$ ) in the program sequence.



### 5.10.10 MIG/MAG program sequence ("Program steps" mode)

Certain materials, such as aluminium, require special functions in order to be able to weld them safely and at high quality. The latched special operating mode is used here with the following programs:

- Start program  $P_{START}$  (reduction of cool points at the start of the seam)
- Main program  $P_A$  (continuous welding)
- Reduced main program  $P_B$  (targeted heat reduction)
- End program  $P_{END}$  (minimisation of end craters via targeted heat reduction)

The programs include the parameters wire speed (operating point), arc length correction, slope times, program duration, etc.

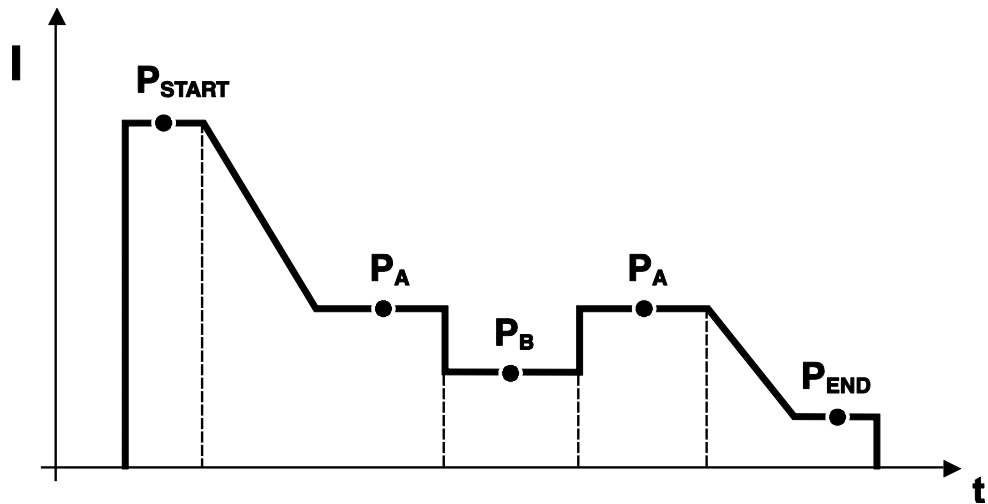

Figure 5-23



*This function can only be enabled with the PC300.NET software.  
(See operating instructions for the software)*

### 5.10.10.1 Example, tack welding (non-latched)

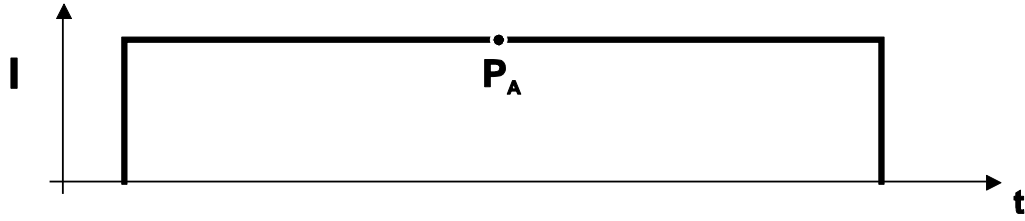

Figure 5-24

### 5.10.10.2 Example, aluminium tack welding (non-latched special)

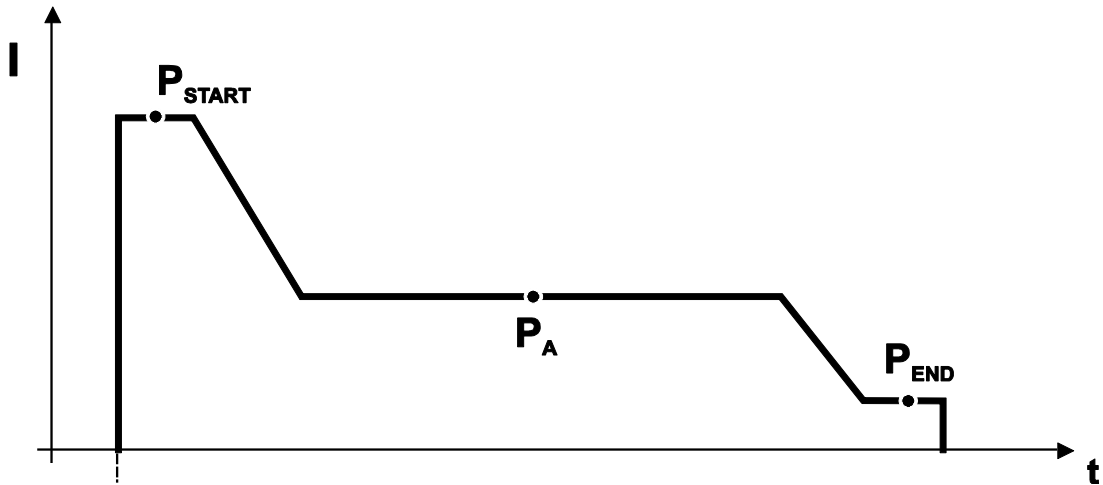

Figure 5-25

### 5.10.10.3 Example, aluminium welding (latched special)

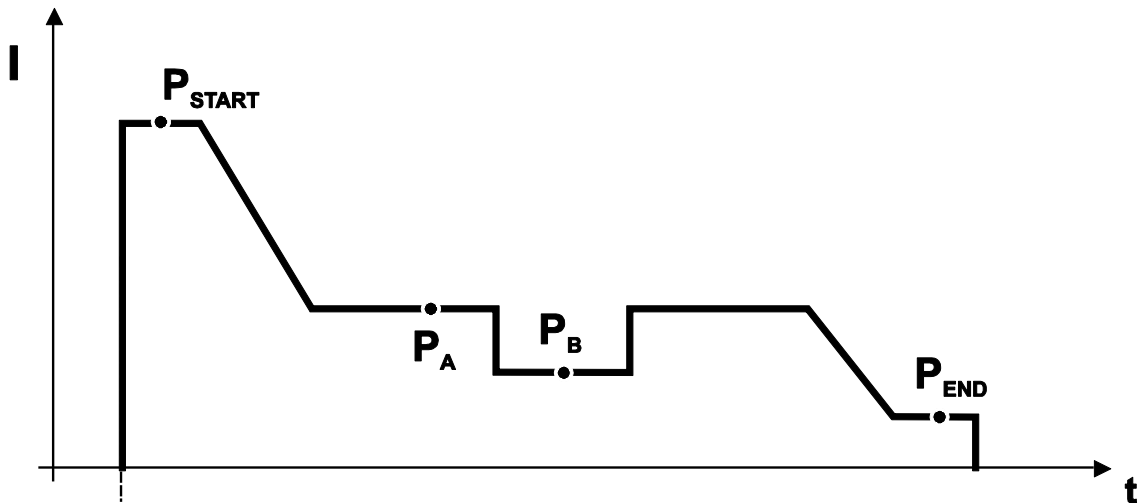

Figure 5-26

### 5.10.11 Main program A mode

Different welding tasks or positions on a workpiece demand various welding performances (operating points) or welding programs. The following parameters are stored in each of the up to 16 programs:

- Operating mode
- Welding type
- Wire feed speed (DV2)
- Voltage correction (U2)
- Dynamics (DYN2)

The user can change the main program welding parameters using the following components.

	Program switching	JOB switching	Program	Operating mode	Welding process	Wire speed	Voltage correction	Dynamics
<b>M3.7x</b> Wire feeder control	Yes	Yes	P0	Yes		Yes	Yes	
			P1...15			Yes		
<b>R20</b> Remote control	Yes	No	P0	No		Yes		No
			P1...9			Yes <sup>1)</sup>		
<b>R40</b> Remote control	Yes	No	P0	No	Yes	Yes		No
						No		
<b>R50</b> Remote control	Yes	No	P0	Yes		Yes		
			P1...15					
<b>PC 300.NET</b> Software	No	No	P0	Yes		No		
			P1...15					
<b>Up/Down</b> Welding torch	Yes	No	P0	No		Yes	No	
			P1...9			No		
<b>2 Up/Down</b> Welding torch	Yes	No	P0	No		Yes		No
			P1...15			No		
<b>PC 1</b> Welding torch	Yes	No	P0	No		Yes	No	
			P1...15			No		
<b>PC 2</b> Welding torch	Yes	Yes	P0	No		Yes		No
			P1...15			No		

1) in case of correction mode, refer to Special parameters "P7 – correction mode, limit value setting"

**Example 1: Welding workpieces with different sheet metal thicknesses (non-latched)**

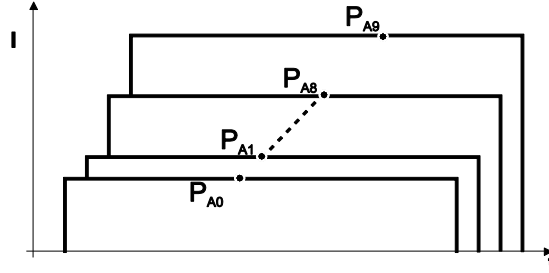

Figure 5-27

**Example 2: Welding different positions on a workpiece (latched)**

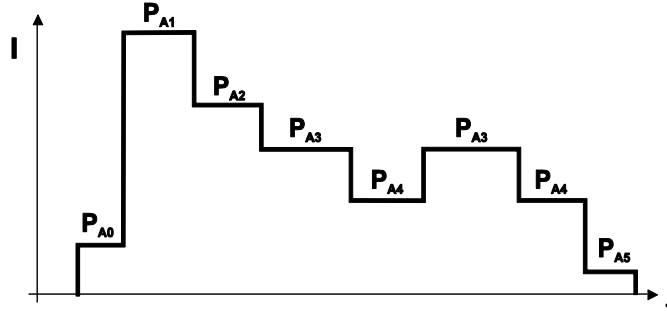

Figure 5-28

**Example 3: Aluminium welding of different sheet metal thicknesses (non-latched or latched special)**

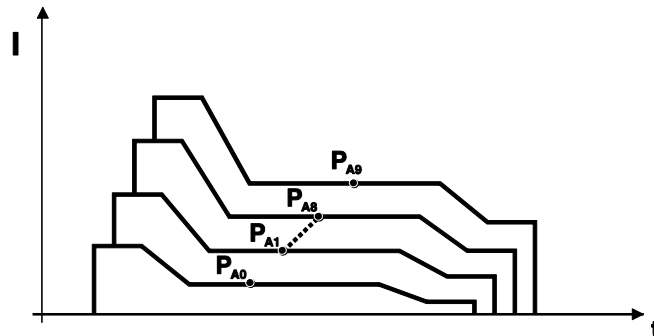

Figure 5-29



**Up to 16 programs ( $P_{A0}$  to  $P_{A15}$ ) can be defined.**  
**An operating point (wire speed, arc length correction, dynamics/choke effect) can be defined permanently in each program.**  
**Program P0 is an exception: the settings for operating points are made manually here.**  
**Changes to the welding parameters are saved immediately!**

**5.10.11.1 Selecting parameters (program A)**

**Changes to the welding parameters can only be made when the key switch is in position "1".**

Operating element	Action	Result	Display
	<b>n x</b>	Change welding data display over to program display. (LED <b>Prog</b> is on)	
		Select program number. Display example: Program "1".	
		Set wire speed. (Absolute value)	
		Set arc length correction. Display example: "-0.8 V" correction (Setting range: -9.9 V to +9.9 V)	
	<b>1 x</b>	Select "Dynamic" program sequence parameter.	
		Set dynamic. (Setting range 40 to -40) 40: Arc hard and narrow. -40: Arc soft and wide.	 

**5.10.12 MIG/MAG automatic cut-out**

**The welding machine ends the ignition process or the welding process with an**

- **ignition fault (no welding current flows within 5 s after the start signal)**
- **arc interruption (arc is interrupted for longer than 5 s)**

## 5.10.13 Standard MIG/MAG torch

The MIG welding torch trigger is essentially used to start and stop the welding process.

Operating elements	Functions
 Torch trigger	<ul style="list-style-type: none"> <li>Start/stop welding</li> </ul>

Other functions are also possible by tapping the torch trigger, depending on the machine type and control configuration- See 5.17 Special parameters (advanced settings) chapter:

- Change over between welding programs (P8).
- Program selection before starting welding (P17).
- Switching between wire feed units in dual operation mode (P10).

## 5.10.14 MIG/MAG special-torches

Function specifications and more indepth information can be found in the operating manual for the relevant welding torch!

### 5.10.14.1 Program- and Up- / down operation

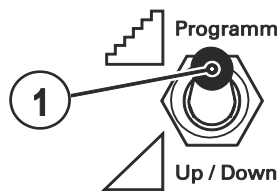



Figure 5-30

Item	Symbol	Description
1		<p><b>Welding torch function changeover switch</b> (special welding torch required)</p> <p>Changing over programs or JOBs</p> <p>Infinite adjustment of welding performance.</p>

### 5.10.14.2 Switching between Push/Pull and intermediate drive

 **DANGER**



**Do not carry out any unauthorised repairs or modifications!**  
**To avoid injury and equipment damage, the unit must only be repaired or modified by specialist, skilled persons!**  
**The warranty becomes null and void in the event of unauthorised interference.**

- Appoint only skilled persons for repair work (trained service personnel)!

**CAUTION**



**Test!**  
**Before re-commissioning, it is essential that an "inspection and test during operation" is carried out conforming to IEC / DIN EN 60974-4 "Arc welding devices - inspection and testing during operation"!**

- For detailed instructions, please see the standard operating instructions for the welding machine.

The plugs are located directly on the M3.7x printed circuit board.

Plug	Function
on X24	Operation with Push/Pull welding torch (factory setting)
on X23	Operation with intermediate drive

## 5.11 TIG welding

### 5.11.1 Welding torch and workpiece line connection

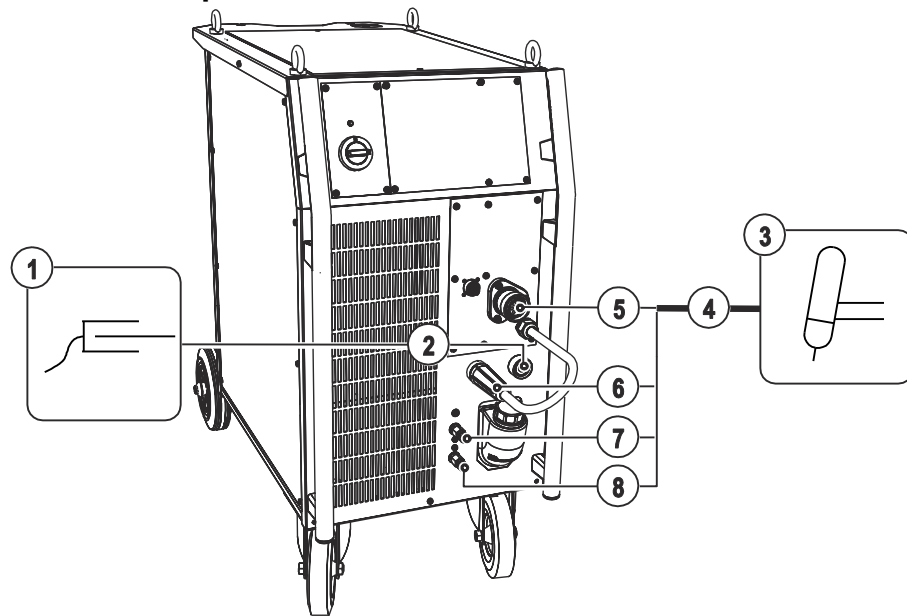

Figure 5-31

Item	Symbol	Description
1		<b>Workpiece</b>
2		<b>Connection socket, "+" welding current</b> • TIG welding: Workpiece connection
3		<b>Welding torch</b>
4		<b>Welding torch hose package</b>
5		<b>Welding torch connection (Euro or Dinse torch connector)</b> Welding current, shielding gas and torch trigger integrated
6		<b>Welding current cable, polarity selection</b> Welding current to the central connector/torch, enables polarity selection. • TIG: Connection socket for "-" welding current
7		<b>Quick connect coupling (red)</b> coolant return
8		<b>Quick connect coupling (blue)</b> coolant supply

- Insert the central plug for the welding torch into the central connector and screw together with crown nut.
- Insert the cable plug on the work piece lead into the "+" welding current connection socket and lock by turning to the right.
- Welding current lead, insert polarity selection into the "-" welding current connection socket and lock.

**Where applicable:**

- Lock connecting nipples of the cooling water tubes into the corresponding quick connect couplings:  
Return line red to quick connect coupling, red (coolant return) and supply line blue to quick connect coupling, blue (coolant supply).

## 5.11.2 Welding task selection

- Select JOB 127 (TIG welding task).

It is only possible to change the JOB number when no welding current is flowing.

Operating element	Action	Result	Display
	1 x	Select JOB number input	
		Set the JOB number The machine adopts the required setting after approx. 3 seconds	

### 5.11.2.1 Welding current setting

The welding current is normally set using the "Wire speed" rotary dial.

Operating element	Action	Result	Displays
		Welding current is set	Setpoint setting

## 5.11.3 TIG arc ignition

### 5.11.3.1 Liftarc ignition

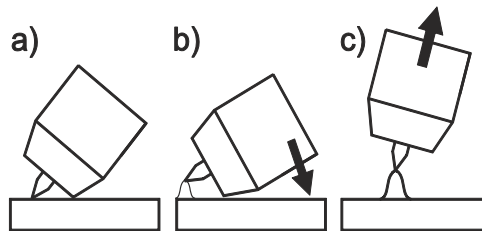

Figure 5-32

**The arc is ignited on contact with the workpiece:**











- Carefully place the torch gas nozzle and tungsten electrode tip onto the workpiece and press the torch trigger (liftarc current flowing, regardless of the main current set).
- Incline the torch over the torch gas nozzle to produce a gap of approx. 2-3 mm between the electrode tip and the workpiece. The arc ignites and the welding current is increased, depending on the operating mode set, to the ignition or main current set.
- Lift off the torch and swivel to the normal position.

**Ending the welding process: Release or press the torch trigger depending on the operating mode selected.**



## 5.11.4 Function sequences/operating modes

### 5.11.4.1 Explanation of signs and functions

Symbol	Meaning
	Press torch trigger
	Release torch trigger
	Tap torch trigger (press briefly and release)
	Shielding gas flowing
I	Welding output
	Gas pre-flows
	Gas post-flows
	Non-latched
	Special, non-latched
	Latched
	Special, latched
t	Time
P <sub>START</sub>	Ignition program
P <sub>A</sub>	Main program
P <sub>B</sub>	Reduced main program
P <sub>END</sub>	End program
tS1	Slope duration from P <sub>START</sub> to P <sub>A</sub>

## Non-latched mode

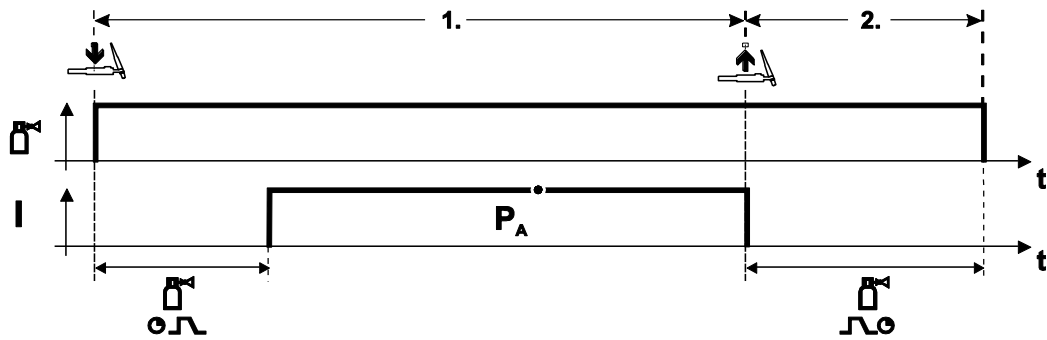

Figure 5-33

### Selection

- Select non-latched operating mode

#### Step 1

- Press and hold torch trigger.
- Shielding gas is expelled (gas pre-flows).

#### The arc is ignited using liftarc.

- Welding current flows with pre-selected setting.

#### Step 2

- Release torch trigger.
- Arc is extinguished.
- Gas post-flow time elapses.

## Special, non-latched

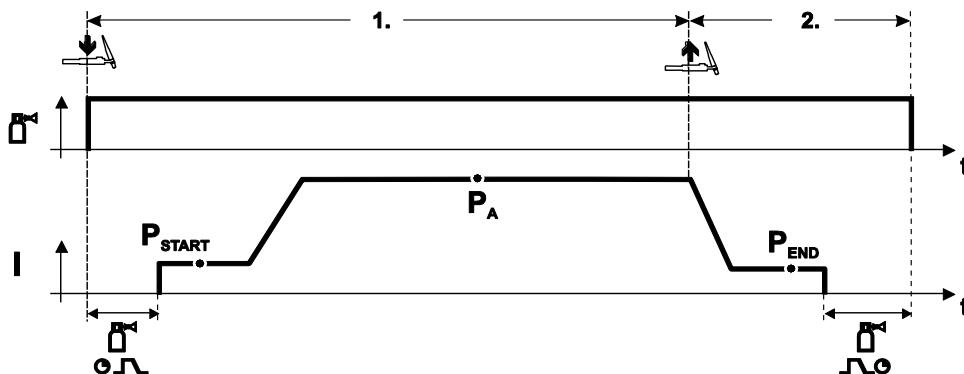

Figure 5-34

### Selection

- Select non-latched special mode

#### Step 1

- Press and hold torch trigger
- Shielding gas is expelled (gas pre-flows)

#### The arc is ignited using liftarc.

- Welding gas flows with pre-selected setting in start program " $P_{START}$ ".
- After the " $t_{start}$ " ignition current time elapses, the welding current rises with the set upslope time " $t_{S1}$ " to the main program " $P_A$ ".

#### Step 2

- Release torch trigger.
- The welding current reduces with the downslope time " $t_{Se}$ " to the end program " $P_{END}$ ".
- After the end current time " $end$ " elapses, the arc will extinguish.
- Gas post-flow time elapses.

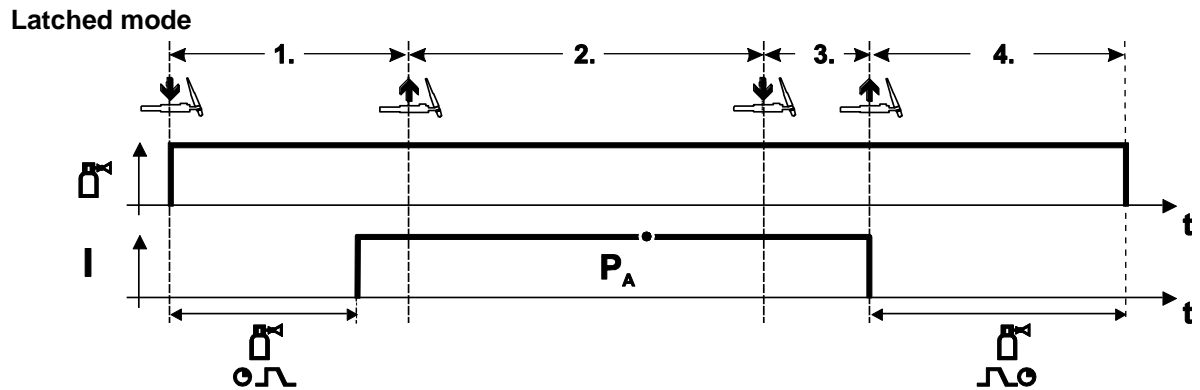

Figure 5-35

**Selection**

- Select latched operating mode 

**Step 1**

- Press and hold torch trigger
- Shielding gas is expelled (gas pre-flows)

**The arc is ignited using liftarc.**

- Welding current flows with pre-selected setting.

**Step 2**

- Release torch trigger (no effect)

**Step 3**

- Press torch trigger (no effect)

**Step 4**

- Release torch trigger
- Arc is extinguished.
- Gas post-flow time elapses.

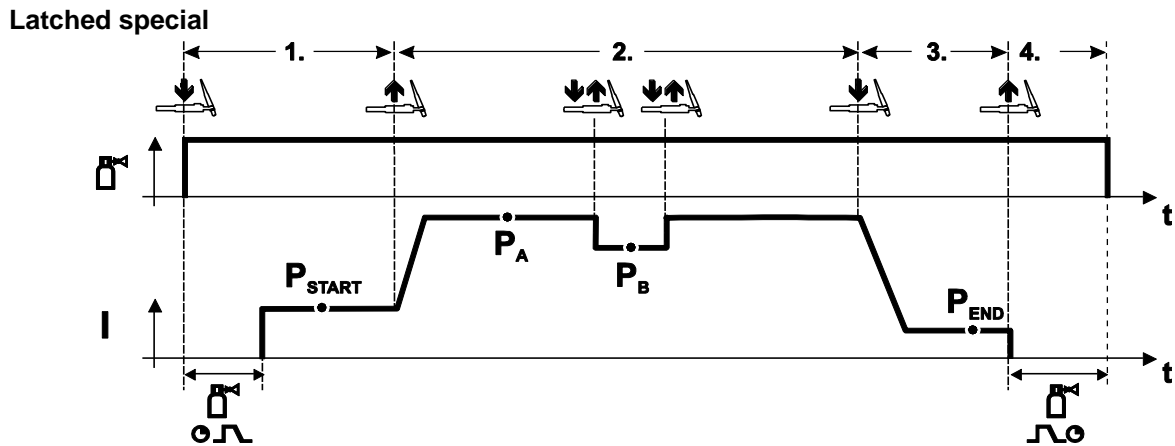

Figure 5-36

### Selection

- Select latched special mode

### Step 1

- Press and hold torch trigger.
- Shielding gas is expelled (gas pre-flows).

### The arc is ignited using liftarc.

- Welding gas flows at pre-selected setting in start program "P<sub>START</sub>".

### Step 2

- Release torch trigger.
- Slope on main program "P<sub>A</sub>".

The slope on main program P<sub>A</sub> is given at the earliest after the set time  $t_{START}$  elapses and at the latest when the torch trigger is released.

Tapping can be used to switch to the reduced main program "P<sub>B</sub>". Repeated tapping will switch back to the main program "P<sub>A</sub>".

### Step 3

- Press the torch trigger.
- Slope to end program "P<sub>END</sub>".

### Step 4

- Release torch trigger.
- Arc is extinguished.
- Gas post-flow time elapses.

### 5.11.4.2 TIG automatic cut-out



*The welding machine ends the ignition process or the welding process with an*

- **ignition fault (no welding current flows within 5 s after the start signal)**
- **arc interruption (arc is interrupted for longer than 5 s)**

## 5.12 MMA welding

### ⚠ CAUTION



**Risk of being crushed or burnt.**

**When replacing spent or new stick electrodes**

- Switch off machine at the main switch
- Wear appropriate safety gloves
- Use insulated tongs to remove spent stick electrodes or to move welded workpieces and
- Always put the electrode holder down on an insulated surface.

### 5.12.1 Connecting the electrode holder and workpiece lead

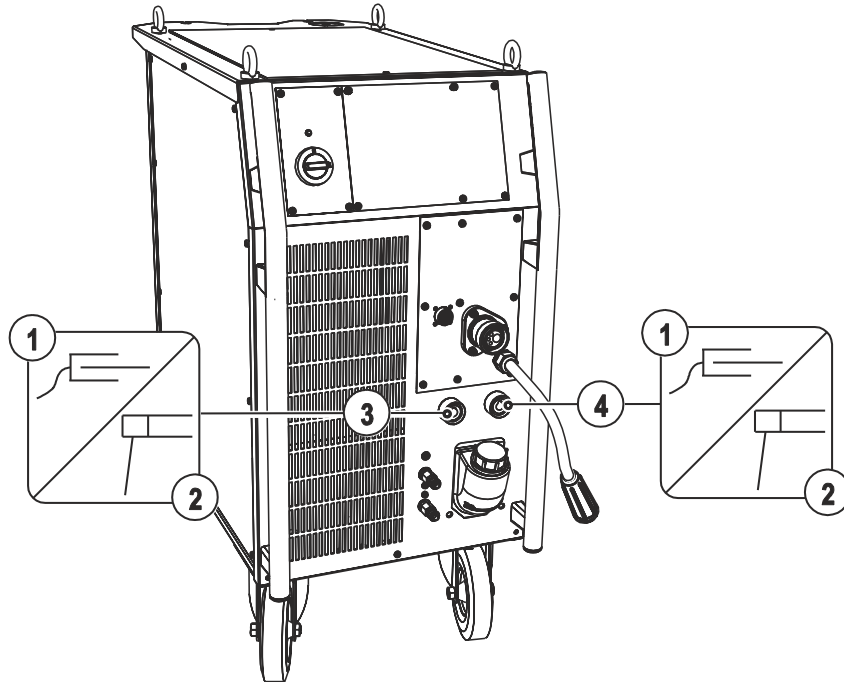

Figure 5-37

Item	Symbol	Description
1		Workpiece
2		Electrode holder
3		Connection socket, "-" welding current
4		Connection socket, "+" welding current

- Insert cable plug of the electrode holder into either the "+" or "-" welding current connection socket and lock by turning to the right.
- Insert cable plug of the workpiece lead into either the "+" or "-" welding current connection socket and lock by turning to the right.



**Polarity depends on the instructions from the electrode manufacturer given on the electrode packaging.**

## 5.12.2 Welding task selection

- Select JOB 128 (MMA welding task).

It is only possible to change the JOB number when no welding current is flowing.

Operating element	Action	Result	Display
  	1 x	Select JOB number input	
		Set the JOB number The machine adopts the required setting after approx. 3 seconds	

### 5.12.2.1 Welding current setting

The welding current is normally set using the "Wire speed" rotary dial.

Operating element	Action	Result	Displays
		Welding current is set	Setpoint setting

### 5.12.2.2 Arcforce

Operating element	Action	Result	Display
		Select arcforcing welding parameter LED for the button ● is on.	
		Arcforcing setting for electrode types: (Setting range -40 to 40) Negative values Rutile Values around zero Basic Positive values Cellulose	 

### 5.12.2.3 Hotstart

The hotstart device improves the ignition of the stick electrodes using an increased ignition current.

- a) = Hotstart time
- b) = Hotstart current
- I = Welding current
- t = Time

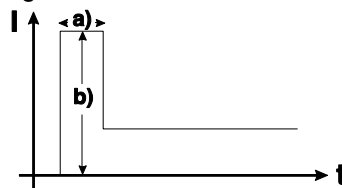
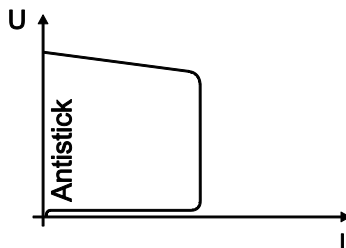

Figure 5-38

### 5.12.2.4 Antistick



**Anti-stick prevents the electrode from annealing.**

If the electrode sticks in spite of the Arcforce device, the machine automatically switches over to the minimum current within about 1 second to prevent the electrode from overheating. Check the welding current setting and correct according to the welding task!

Figure 5-39

## 5.13 Remote control

### CAUTION



**Damage due to the use of non-genuine parts!**

**The manufacturer's warranty becomes void if non-genuine parts are used!**

- Only use system components and options (power sources, welding torches, electrode holders, remote controls, spare parts and replacement parts, etc.) from our range of products!
- Only insert and lock accessory components into the relevant connection socket when the machine is switched off.



*The remote controls are operated via the 19-pole remote control connection socket (analogue) or the 7-pole remote control connection socket (digital), depending on the model.*



*Please note the relevant documentation of the accessory components.*

## 5.14 Interfaces for automation



### DANGER



**Do not carry out any unauthorised repairs or modifications!**

**To avoid injury and equipment damage, the unit must only be repaired or modified by specialist, skilled persons!**

**The warranty becomes null and void in the event of unauthorised interference.**

- Appoint only skilled persons for repair work (trained service personnel)!

### CAUTION



**Damage due to incorrect connection!**

**Accessory components and the power source itself can be damaged by incorrect connection!**

- Only insert and lock accessory components into the relevant connection socket when the machine is switched off.
- Comprehensive descriptions can be found in the operating instructions for the relevant accessory components.
- Accessory components are detected automatically after the power source is switched on.

## 5.14.1 Automation interface

**These accessory components can be retrofitted as an option - See 9 Accessories chapter.**

Pin	Input / output	Description	Diagram
<b>A</b>	Output	PE Connection for cable shielding	
<b>D</b>	Output (open collector)	IGRO Current flows signal I>0 (maximum load 20 mA / 15 V) 0 V = welding current flows	
<b>E + R</b>	Input	Not/Aus Emergency stop for higher level shut-down of the power source. To use this function, jumper 1 must be unplugged on PCB M320/1 in the welding machine. Contact open = welding current off	
<b>F</b>	Output	0 V Reference potential	
<b>G/P</b>	Output	I>0 Power relay contact, galvanically isolated (max. +/-15 V / 100 mA)	
<b>H</b>	Output	Uist Welding voltage, measured against pin F, 0-10 V (0 V = 0 V; 10 V = 100 V)	
<b>L</b>	Input	Str/Stp Start = 15 V / Stop = 0 V <sup>1)</sup>	
<b>M</b>	Output	+15 V Voltage supply (max. 75 mA)	
<b>N</b>	Output	-15 V Voltage supply (max. 25 mA)	
<b>S</b>	Output	0 V Reference potential	
<b>T</b>	Output	list Welding current, measured on pin F; 0-10 V (0 V = 0 A, 10 V = 1000 A)	

<sup>1)</sup> The operating mode is given by the wire feed unit (the start / stop function equates to pressing the torch trigger and is used in mechanised applications, for example).



## 5.14.2 Remote control connection socket, 19-pole

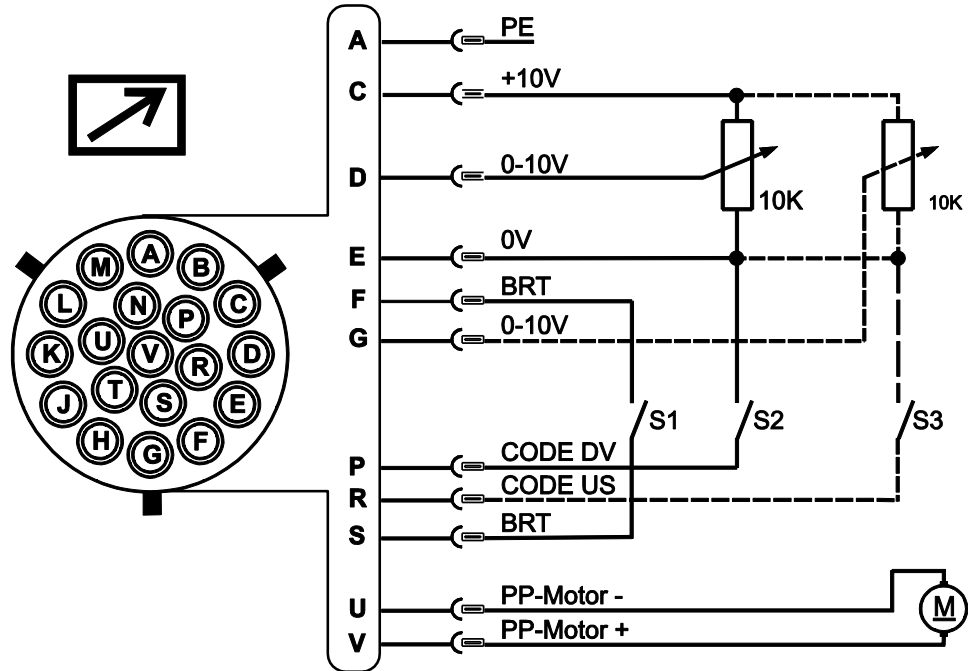

Figure 5-40

Pin	Signal form	Short description
A	Output	Connection for PE cable screen
C	Output	Reference voltage for potentiometer 10 V (max. 10 mA)
D	Input	Control voltage specification (0 V–10 V) – wire feed speed
E	Output	Reference potential (0 V)
F/S	Input	Welding power start/stop (S1)
G	Input	Control voltage specification (0 V–10 V) – arc length correction
P	Input	Activation of control voltage specification for wire feed speed (S2) For activation, put signal to reference potential 0 V (pin E)
R	Input	Activation of control voltage specification for arc length correction (S3) For activation, put signal to reference potential 0 V (pin E)
U/V	Output	Supply voltage push/pull welding torch

## 5.14.3 RINT X12 robot interface

The standard digital interface for mechanised applications  
(optional, retrofitting on the machine or external fitting by the customer)

### Functions and signals:

- Digital inputs: start/stop, operating modes, JOB and program selection, inching, gas test
- Analogue inputs: control voltages, e.g. for welding performance, welding current, etc.
- Relay outputs: process signal, ready for welding, system composite fault, etc.

## 5.14.4 BUSINT X11 Industrial bus interface

The solution for easy integration with automated production with e.g.

- Profinet/Profibus
- EnthernetIP/DeviceNet
- EtherCAT

etc.

## 5.15 PC Interfaces

### CAUTION



#### Damage due to the use of non-genuine parts!

**The manufacturer's warranty becomes void if non-genuine parts are used!**

- Only use system components and options (power sources, welding torches, electrode holders, remote controls, spare parts and replacement parts, etc.) from our range of products!
- Only insert and lock accessory components into the relevant connection socket when the machine is switched off.



#### Equipment damage or faults may occur if the PC is connected incorrectly!

**Not using the SECINT X10USB interface results in equipment damage or faults in signal transmission. The PC may be destroyed due to high frequency ignition pulses.**

- Interface SECINT X10USB must be connected between the PC and the welding machine!
- The connection must only be made using the cables supplied (do not use any additional extension cables)!



*Please note the relevant documentation of the accessory components.*

### PC 300 welding parameter software

Create all welding parameters quickly on the PC and easily transfer them to one or more welding machines (accessories: set consisting of software, interface, connection leads).

### Q-DOC 9000 welding data documentation software

(Accessories: set consisting of software, interface, connection leads)

The ideal tool for welding data documentation of, for example:  
welding voltage and current, wire speed and motor current.

### WELDAQS welding data monitoring and documentation system

Network-compatible welding data monitoring and documentation system for digital machines

## 5.16 Protecting welding parameters from unauthorised access

 **The key switch is only available for machines which are fitted with the "OW KL XX5" option ex works.**

To protect against unauthorised or unintentional adjustment of the welding parameters on the machine, the control input can be locked with the aid of a key switch.

In key switch position 1 all functions and parameters can be set without restriction.

In key switch position 0 the following functions and parameters cannot be changed:

- No adjustment of the operating point (welding performance) in programs 1–15.
- No change of welding or operating mode in programs 1–15.
- The welding parameters can be displayed but not changed in the control's function sequence.
- No welding task switching (JOB block operation P16 possible).
- No change of special parameters (except P10). Restart required.

## 5.17 Special parameters (advanced settings)

Special parameters (P1 to Pn) are applied for customer-specific configuration of machine functions. This allows the user maximum flexibility in optimising their requirements.

These settings are not configured directly on the machine control since a regular setting of the parameters is generally not required. The number of selectable special parameters can deviate between the machine controls used in the welding system (also see the relevant standard operating instructions).

If required, the special parameters can be reset to the factory settings- See 5.17.1.1 Reset to factory settings chapter.

### 5.17.1 Selecting, changing and saving parameters

 **ENTER (Enter the menu)**

- **Switch off machine at the main switch.**
- **Press and hold the "left parameter selection" button and switch the machine on again at the same time.**

**NAVIGATION (Navigate the menu)**

- **Select parameters by turning the "welding parameter setting" rotary dial.**
- **Set or change the parameters by turning the "arc length correction/select welding program" rotary dial.**

**EXIT (Exit the menu)**

- **Press the "right parameter selection" button (switch machine off and on again).**

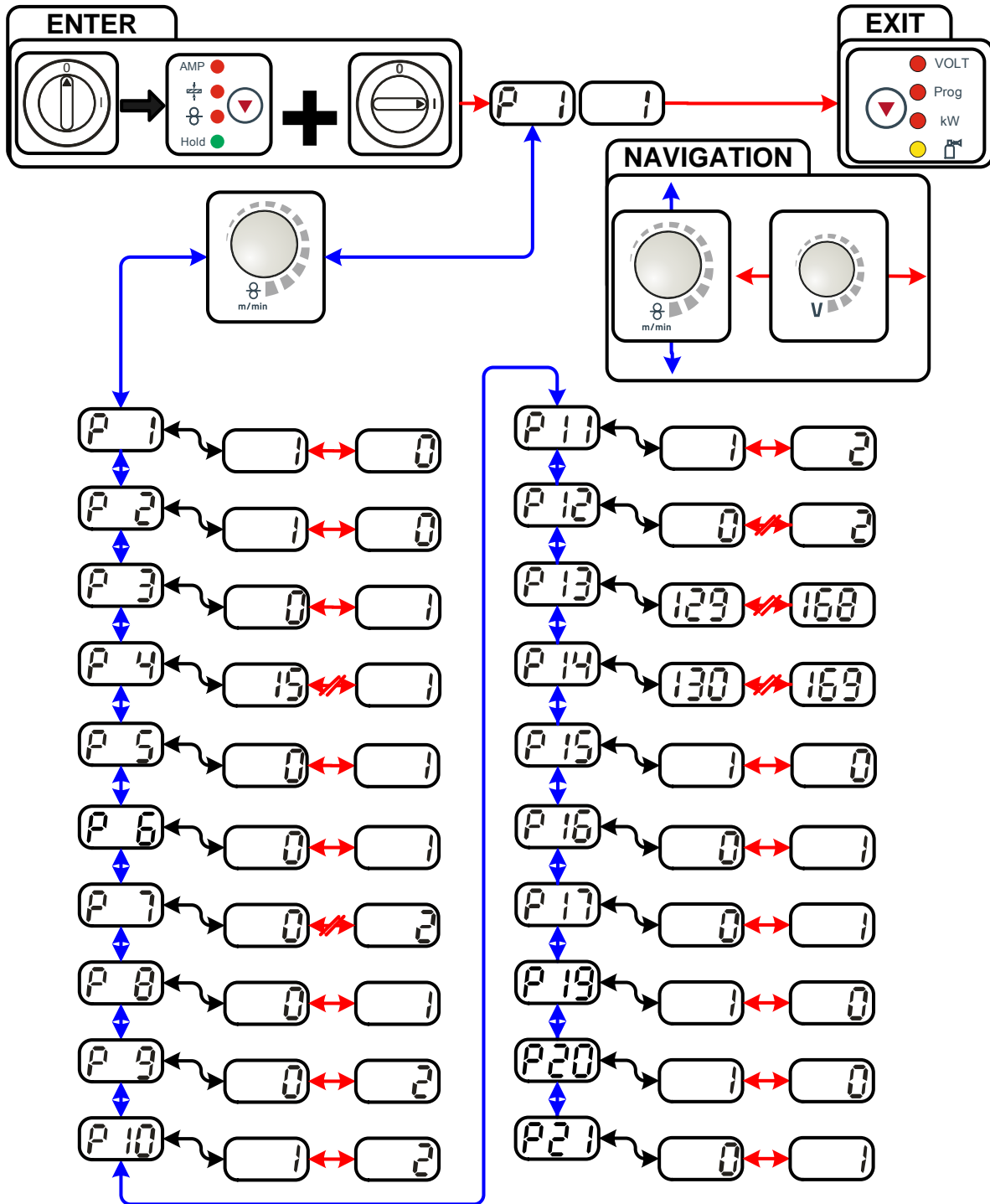

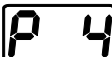





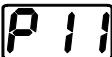
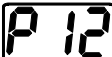

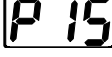
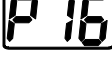
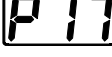

Figure 5-41

Display	Setting/selection
<b>P 1</b>	<b>Ramp time for wire inching</b> 0 = normal inching (10s ramp time) 1 = fast inching (3s ramp time) (Ex works)
<b>P 2</b>	<b>Block program "0"</b> 0 = P0 enabled (Ex works) 1 = P0 blocked

Display	Setting/selection
	<b>Display mode for Up/Down welding torch with one-digit 7-segment display (two keys)</b> 0 = normal display (ex works) program number/JOB or welding performance/welding voltage correction is shown 1 = alternating display display switches between program number and welding method
	<b>Program limitation</b> Programs 1 to max. 15 Ex works: 15
	<b>Special cycle in the special latched and non-latched operating modes</b> 0 = normal (previous) non-latched/latched (Ex works) 1 = WF3 cycle for non-latched/latched
	<b>Enable special jobs SP1 to SP3</b> 0 = no enabling (Ex works) 1 = enabling of Sp1-3
	<b>Correction operation, threshold value setting</b> 0 = correction operation switched off (Ex works) 1 = correction operation on "Main program (PA)" flashing
	<b>Program changeover with standard torch</b> 0 = no program changeover (Ex works) 1 = special latched 2 = specific latched special (n cycle active)
	<b>Lat. and sp. lat. tapping start</b> 0 = no latched tapping start (Ex works) 1 = latched tapping start possible
	<b>One or two-wire feed operation</b> 0 = single operation (Ex works) 1 = dual operation, this unit is the "master" 2 = dual operation, this unit is the "slave"
	<b>Special latched tapping time</b> 0 = tapping function switched off 1 = 300ms (Ex works) 2 = 600ms
	<b>JOB list changeover</b> 0 = task-oriented JOB list 1 = actual JOB list (Ex works) 2 = actual JOB list, JOB changeover activated via accessories
	<b>Lower limit remote JOB changeover</b> Lowest JOB that can be selected using PowerControl 2 torches. Lower limit: 129 (Ex works)
	<b>Upper limit remote JOB changeover</b> JOB range of the POWERCONTROL2 torch Upper limit: 169 (Ex works)
	<b>HOLD function</b> 0 = HOLD values are not displayed 1 = HOLD values are displayed (Ex works)
	<b>Block JOB mode</b> 0 = Block JOB mode not enabled (Ex works) 1 = Block JOB mode enabled
	<b>Program selection with standard torch trigger</b> 0 = no program selection (Ex works) 1 = program selection possible

Display	Setting/selection
	<b>Mean value display for superPuls</b> 0 = Function switched off. 1 = Function switched on (ex factory).
	<b>Predefined pulse arc welding process in the PA program</b> 0 = Predefined pulse arc welding process in the PA program is disabled. 1 = If the superPuls and welding process switching functions are available and activated, the pulse arc welding process is always executed in the main program PA (ex factory).
	<b>Predefined absolute value for relative programs</b> Start program (P <sub>START</sub> ), down-slope program (P <sub>B</sub> ) and end program (P <sub>END</sub> ) can be set relative to the main program (P <sub>A</sub> ) or in an absolute manner, as desired. 0 = Relative parameter setting (ex factory) 1 = Absolute parameter setting

### 5.17.1.1 Reset to factory settings



**All special parameters saved by the user will be overwritten by the factory settings!**

Operating element	Action	Result
		Switch off welding machine
		Keep the button pressed
		Switch on welding machine
		Release the button, wait about 3 seconds
		Switch off welding machine and restart in order to put the changes into effect

**5.17.1.2 Special parameters in detail****Ramp time for wire inching (P1)**

The wire inching starts with a speed 1.0 m/min for 2 secs. It is subsequently increased to a ramp function to 6.0 m/min. The ramp time can be set between two ranges.

During wire inching, the speed can be changed by means of the welding parameter setting rotary dial. Changing the speed has no effect on the ramp time.

**Program "0", releasing the program block (P2)**

The program P0 (manual setting) is blocked. Only operation with P1-P15 is possible, irrespective of the key switch position.

**Display mode for Up/Down welding torch with one-digit 7-segment display (P3)****Normal display:**

- Program operation: Program number
- Up/down operation: Up/down setting

**Alternating display:**

- Program operation: Change program number and welding process (pulse/non-pulse)
- Up/down operation: Change up/down setting and up/down symbol

**Program limit (P4)**

Program selection can be limited with the special parameter P4.

- The setting is adopted for all JOBs.
- Program selection depends on the position of the "welding torch function" changeover switch (see "Machine description"). Programs can only be switched when the changeover switch is in the "program" position.
- Programs can be switched by means of a connected remote control or special welding torch.
- If a special welding torch or a remote control is not connected, it is only possible to switch programs by means of the "arc length correction/select welding program" rotary dial (see "Machine description").

**Special cycle in the operating modes special latched and non-latched (P5)**

With the special sequence activated, the start of the welding process changes as follows:

**Sequence for special non-latched mode/special latched mode:**

- Start program "P<sub>START</sub>"
- Main program "P<sub>A</sub>"

**Sequence for special non-latched mode/special latched mode with custom sequence activated:**

- Start program "P<sub>START</sub>"
- Reduced main program "P<sub>B</sub>"
- Main program "P<sub>A</sub>"

**Enabling special JOBs SP1 to SP3 (P6)*****For machine version Phoenix Expert only.***

Phoenix Expert machine series:

The welding task is set at the power source control; refer to the relevant system documentation.

If required, the predefined special welding tasks SP1 = JOB 129 / SP2 = JOB130 / SP3 = JOB 131 only can be selected at the wire feeder control. The special JOBs are selected by pressing the welding task selection push-button for a longer period. The special JOBs are switched by pressing the push-button briefly.

The JOB changeover is blocked if the key switch is in the "0" position.

This block can be cancelled for the special JOBs (SP1 - SP3).

## Correction operation, threshold value setting (P7)

The correction operation is switched on and off for all JOBS and their programs at the same time. A correction operation is specified for wire speed (DV) and welding voltage correction (U<sub>korr</sub>) for each JOB. The correction value is saved separately for each program. The correction range can be maximum 30% of the wire speed and +/-9.9 V welding voltage.

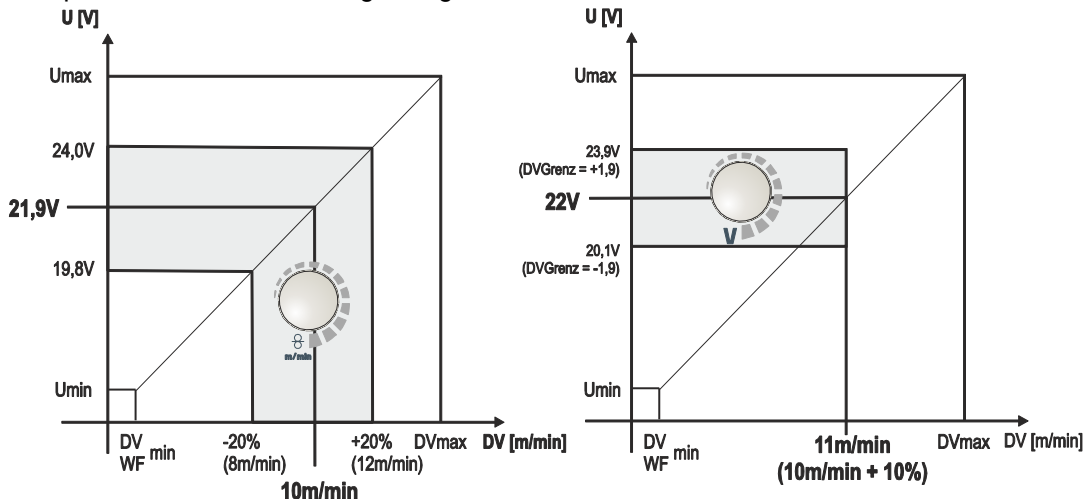

Figure 5-42

### Example for the operating point in correction mode:

The wire speed in one program (1 to 15) is set on 10.0 m/min.

This corresponds to a welding voltage (U) of 21,9 V. When the key switch is set to "0" position, welding in this program can only be carried out with these values.

To allow the welder also to perform wire and voltage correction in program mode, the correction mode must be switched on and limit values for wire and voltage must be specified.

Setting of the correction limit value = WFLimit = 20% / Ulimit = 1.9 V

Now the wire speed can be corrected by 20% (8.0 up to 12.0 m/min) and the welding voltage by +/-1.9 V (3.8 V).

In the example the wire speed is set on 11.0 m/min. This corresponds to a welding voltage of 22 V

Now the welding voltage can be corrected by further 1.9 V (20.1 V and 23.9 V).

**The values for voltage and wire-speed correction will be reset if the key switch is moved to the "1" setting.**

### Setting the correction range:

- Switch on the "Correction operation" special parameter (P7=1) and save the setting.
  - See 5.17.1 Selecting, changing and saving parameters chapter
- Key switch to position "1".
- Set correction range according to the following table:



Operating element	Action	Result	Display (examples)	
			Left	Right
		Press button until "PROG" LED comes on. Left: Wire feed speed Right: Program number		
		Press button and hold down for approx. 4 s Left: Current limit value of the wire feed speed correction Right: Current limit value of the voltage correction		
		Set limit value for the wire feed speed correction		
		Set limit value for voltage correction		
After approx. 5 s without further user intervention, the set values are adopted and the display switches back to the program display,				

- Key switch back to position "0"!

## Switching programs with the standard torch trigger (P8)

### Special latched (latched absolute program sequence)

- Cycle 1: absolute program 1 is run
- Cycle 2: absolute program 2 is run after completion of "tstart".
- Cycle 3: absolute program 3 is run until the "t3" time has elapsed. The program then switches automatically to absolute program 4.

Accessory components such as remote controls or special torches may not be connected!  
Program switching at the wire feed unit control is disabled.

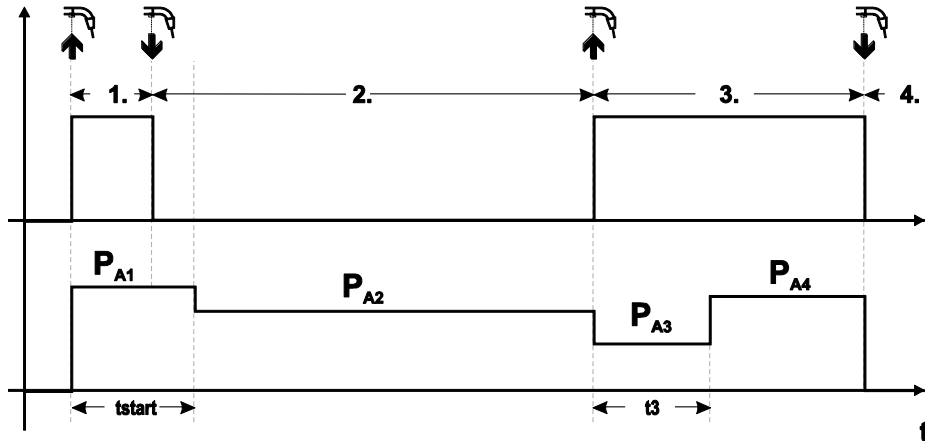

Figure 5-43

### Specific latched special (n cycle)

In the n cycle program sequence, the unit starts in the 1st cycle with start program  $P_{start}$  from  $P_1$ . In the second cycle, the machine switches to absolute program 2, once the start time "tstart" has elapsed. Tapping switches to other programs ( $P_{A1}$  to max.  $P_{A9}$ ).

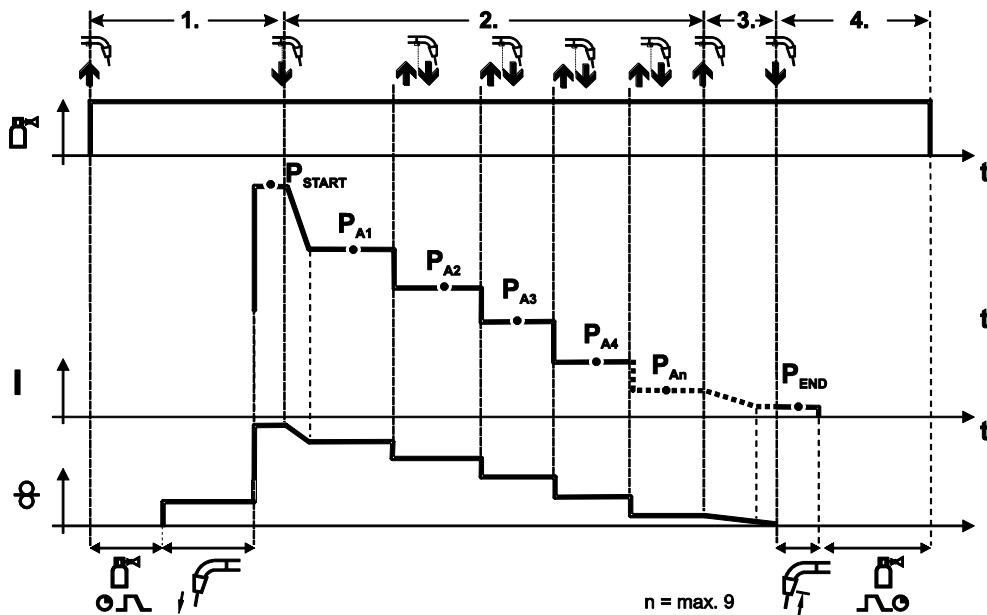

Figure 5-44

The number of programs ( $P_{AN}$ ) corresponds to the cycle number specified under N cycle.

#### 1st cycle

- Press and hold torch trigger.
- Shielding gas is expelled (gas pre-flows).
- Wire feed motor runs at "creep speed".
- Arc ignites after the wire electrode makes contact with the workpiece, welding current is flowing (start program  $P_{START}$  from  $P_{A1}$ )

#### 2nd cycle

- Release torch trigger.
- Slope to main program  $P_{A1}$ .

The slope to main program  $P_{A1}$  is given at the earliest after the set time  $t_{START}$  elapses and at the latest when the torch trigger is released. Tapping (pressing briefly and releasing within 0.3 sec) can switch to other programs. Programs  $P_{A1}$  to  $P_{A9}$  are possible.

#### 3rd cycle

- Press and hold torch trigger.
- Slope to end program  $P_{END}$  from  $P_{AN}$ . The program can be stopped at any time by pressing the torch trigger longer than 0.3 sec.  $P_{END}$  from  $P_{AN}$  is then executed.

#### 4th cycle

- Release torch trigger.
- WF motor stops.
- Arc is extinguished after the pre-selected wire burn-back time elapses.
- Gas post-flow time elapses.

#### Latched/special-latched tap start (P9)

In latched – tap start – operating mode it is possible to switch straight to the second step by tapping the torch trigger; it is not necessary for current to be flowing.

The welding can be halted by pressing the torch trigger for a second time.

#### "Single or dual operation" (P10) setting



***If the system is fitted with two wire feeds, no further accessory components may be operated on the 7-pole connection socket (digital)!***

***This relates to digital remote controls, robot interfaces, documentation interfaces, welding torches with digital control lead connection, etc.***

#### No second wire feed may be connected in single operation (P10 = 0)!

- Remove connections to the second wire feed

**In dual operation (P10 = 1 or 2), both wire feed units must be connected and configured differently on the controls for this operating mode!**

- Configure one wire feed unit as the master (P10 = 1)
- Configure the other wire feed unit as a slave (P10 = 2)

**Wire feed units with key switches (optional, - See 5.16 Protecting welding parameters from unauthorised access chapter) must be configured as masters (P10 = 1).**

**The wire feed configured as the master is active after the welding machine is switched on. There are no other functional differences between the wire feeds.**

## Latched special tapping time setting (P11)

The tapping time for changing over between the main program and reduced main program can be set in three levels.

0 = no tapping

1 = 320ms (factory setting)

2 = 640ms

## JOB list switching (P12)

Value	Designation	Explanation
0	Task-oriented JOB list	The JOB numbers are sorted by welding wires and shielding gases. JOB numbers may be skipped during selection where relevant.
1	Actual JOB list	JOB numbers correspond to the actual memory cells. Each JOB can be selected; no memory cells are skipped during selection.
2	Actual JOB list, JOB changeover active	As for the actual JOB list. JOB changeover is also possible with accessory components, such as the PowerControl 2 torch.

## Creating user-defined JOB lists

**A consecutive memory range where accessories such as the POWERCONTROL 2 torch can be used to switch between JOBS will be created.**

- Set special parameter P12 to "2".
- Set "Program or Up/Down function" changeover switch to "Up/Down" position.
- Select an existing JOB which is closest to the required result.
- Copy JOB to one or more target JOB numbers.

If any JOB parameters need to be changed, select the target JOBS in sequence and change the parameters individually.

- Set special parameter P13 to the lower limit and
- Set special parameter P14 to the upper limit of the target JOBS.
- Set "Program or Up/Down function" changeover switch to "Program" position.

JOBS can be changed over in the specified range using the accessory component.

## Copying JOBS, "Copy to" function

The possible target range is between 129 - 169.

- First configure special parameter P12 to P12 = 2 or P12 = 1!

Operating element	Action	Result	Display
	1 x	Select JOB list	
		Select the source JOB	
-	-	Wait for around 3 seconds until the JOB has been transferred	
	1 x	Keep button pressed for around 5s	
		Setting to copy function ("Copy to")	
		Select JOB number of the target JOB	
	1 x	Save The JOB is copied to the new position	

By repeating the last two steps, the same source JOB can be copied to multiple target JOBS.

If the control does not register any user activity for longer than 5 seconds, the parameter display is shown once more and the copy process is complete.

### Lower and upper limits of the remote JOB changeover process (P13, P14)

The highest and lowest JOB numbers which can be selected using accessory components, such as the PowerControl 2 torch.

Avoids an accidental changeover into undesirable or undefined JOBS.

### Hold function (P15)

#### Hold function active (P15 = 1)

- Mean values for the last main program parameters used for welding are displayed.

#### Hold function not active (P15 = 0)

- Setpoint values for the main program parameters are displayed.

## Block JOB mode (P16)

The following accessory components support block JOB mode:

- Up/Down welding torch with one-digit 7-segment display (two keys)

Program 0 is always active in JOB 0 and program 1 in all other JOBS

In this operating mode, a total of 27 JOBS (welding tasks) divided into three blocks can be called up using accessory components.

The following settings must be made in order to be able to use block JOB mode:

- Switch the "Program or Up/Down function" changeover switch to "Program"
- Set the JOB list to actual JOB list (special parameter P12 = "1")
- Enable block JOB mode (special parameter P16 = "1")
- Change to block JOB mode by selecting one of the special JOBS 129, 130 or 131.

**Simultaneous operation with interfaces such as RINT X12, BUSINT X11, DVINT X11 or digital accessory components such as is the R40 remote control is not possible!**

**Allocation of JOB numbers to the display on the accessory components**

JOB no.	Display/selection on the accessory component									
	0	1	2	3	4	5	6	7	8	9
Special JOB 1	129	141	142	143	144	145	146	147	148	149
Special JOB 2	130	151	152	153	154	155	156	157	158	159
Special JOB 3	131	161	162	163	164	165	166	167	168	169

### JOB 0:

This JOB allows you to set the welding parameters manually.

Selection of JOB 0 can be prevented via the key switch or with the "block program 0" parameter (P2).

Key switch position 0, or special parameter P2 = 0: JOB 0 is blocked.

Key switch position 1, or special parameter P2 = 1: JOB 0 can be selected.

### JOBS 1-9:

Nine JOBS can be called up in each special JOB (see table).

Nominal values for wire speed, arc correction, dynamics etc must be defined in advance in these JOBS. This can be done easily with the PC300.NET software.

If the software is not available, user-defined JOB lists can be created in the special JOB areas with the "Copy to" function. (See explanations about this in the "Switching JOB lists (P12)" chapter)

## Selecting programs with the standard torch trigger (P17)

Allows you to select a program or switch a program before starting welding.

You switch to the next program by tapping the torch trigger. Once the last enabled program is reached, you start again at the beginning.

- Program 0 is the first enabled program, provided that it is not blocked. (see also special parameter P2).
- The last enabled program is P15.
  - If the programs are not limited by special parameter P4 (see special parameter P4).
  - Or if the programs are limited for the selected JOB by the n cycle setting (see parameter P8).
- Welding starts when the torch trigger is held for longer than 0.64 s.

You can select programs with the standard torch trigger in all operating modes (non-latched, special non-latched, latched and special latched).

**Mean value display for superPuls (P19)****Function active (P19 = 1)**

- For superPuls, the performance **mean value** from program A ( $P_A$ ) and program B ( $P_B$ ) is shown on the display (ex factory).

**Function inactive (P19 = 0)**

- Only the performance of program A is displayed for superPuls.



***If the function is enabled and only "000" is shown on the machine display, this is a rare case of an incompatible system set-up. Solution: Disable special parameter P19.***

**Predefined execution of the pulsed arc welding process in the PA program (P20)**

***For machine versions with pulsed arc welding procedures only.***

**Function active (P20 = 1)**

- If the superPuls and welding process switching functions are available and activated, the pulse arc welding process is always executed in the main program PA (ex factory).

**Function inactive (P20 = 0)**

- Predefined execution of the pulse arc welding process in the PA program is disabled.

**Predefined absolute value for relative programs (P21)**

Start program ( $P_{START}$ ), down-slope program ( $P_B$ ) and end program ( $P_{END}$ ) can be set relative to the main program ( $P_A$ ) or in an absolute manner, as desired.

**Function active (P21 = 1)**

- Absolute parameter setting

**Function inactive (P21 = 0)**

- Relative parameter setting (ex factory)

## 5.18 Machine configuration menu

### 5.18.1 Selecting, changing and saving parameters

**ENTER (Enter the menu)**

- Switch off the machine at the main switch.
- Press and hold the "welding parameters" or "choke effect" (drive 4X LP) push-button and switch the machine on again at the same time.

**NAVIGATION (Navigate the menu)**

- Select parameters by turning the "welding parameter setting" rotary knob.
- Set or change parameters by turning the "arc length correction/select welding program" rotary knob.

**EXIT (Exit the menu)**

- Press the "parameter selection right" push-button (switch machine off and on again).

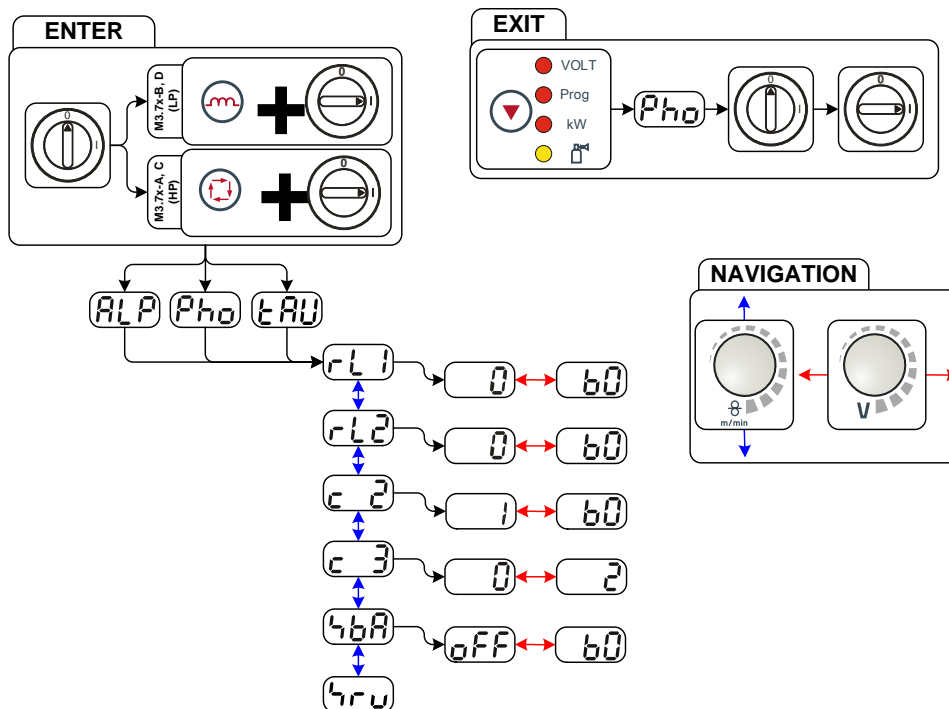

Figure 5-45

Display	Setting/selection
	<b>Lead resistance 1</b> Lead resistance for the first welding circuit 0 mΩ–60 mΩ (8 mΩ ex works).
	<b>Lead resistance 2</b> Lead resistance for the second welding circuit 0 mΩ–60 mΩ (8 mΩ ex works).
	<b>Only qualified service personnel may change the parameters!</b>
	<b>Only qualified service personnel may change the parameters!</b>
	<b>Time-based power-saving mode</b> <ul style="list-style-type: none"> <li>• 5 min.–60 min. = Time to activation of power-saving mode in case of inactivity.</li> <li>• off = inactivated</li> </ul>
	<b>Service menu</b> Modifications to the service menu may only be carried out by authorised maintenance staff!



### 5.18.2 Aligning the cable resistance

The resistance value of cables can either be set directly or it can be aligned using the power source. The factory setting of the power sources is 8 mΩ. This value corresponds to a 5 m earth cable, a 1.5 m intermediate hose package and a 3 m water-cooled welding torch. With other hose package lengths, it is necessary to carry out a +/- voltage correction to optimise welding properties. The voltage correction value can be set close to zero by means of realigning the cable resistance. It is recommended to align the electric cable resistance after replacing accessories such as torches or intermediate hose packages.

In case a second wire feeder is used the (rL2) parameter has to be aligned. For all other configurations it is sufficient to align the (rL1) parameter.

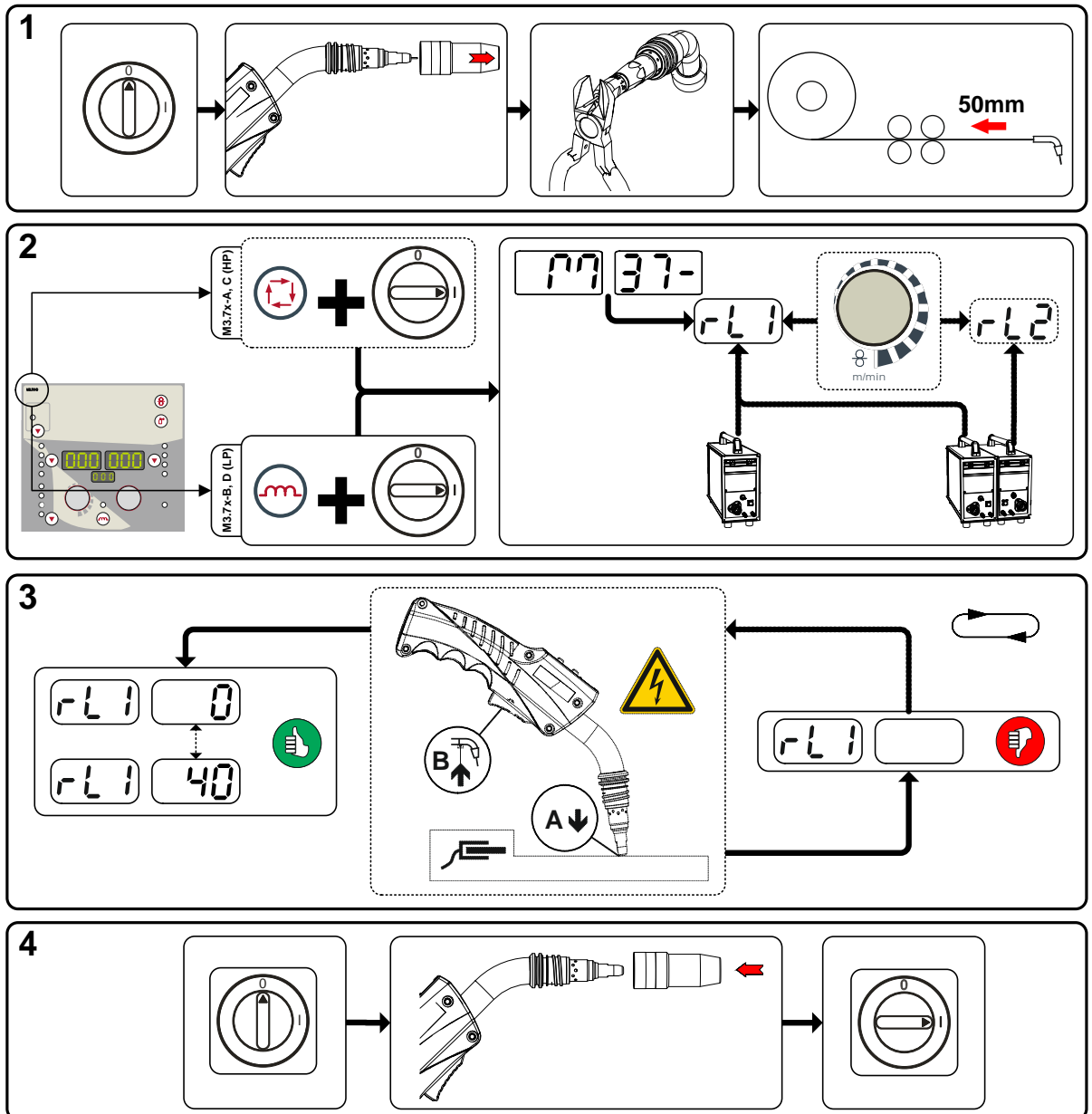

Figure 5-46

## 1 Preparation

- Switch off the welding machine.
- Unscrew the gas nozzle from the welding torch.
- Trim the welding wire, so that it is flush with the contact tip.
- Retract the welding wire a little (approx. 50 mm) on the wire feeder. There should now be no more welding wire in the contact tip.

## 2 Configuration

- Press the "welding parameter or choke effect" push-button while simultaneously switching on the welding machine. Release push-button.
  - "Welding parameter" push-button on the M3.7x-A and M3.7x-C control.
  - "Choke effect" push-button on the M3.7x-B and M3.7x-D control.
- The required parameter can now be selected using the 'Welding parameter setting' rotary knob. Parameter rL1 must be aligned for all machine combinations. In case of welding systems with a second power circuit – if two wire feeders are to be operated from a single power source, for example – a second alignment with parameter rL2 must be performed.

## 3 Alignment/measurement

- Applying slight pressure, put the welding torch in place with the contact tip on a clean, purged location on the workpiece and then press the torch trigger for approx. 2 seconds. A short-circuit current will flow briefly, which is used to determine and display the cable resistance. The value can be between 0 mΩ and 40 mΩ. The new value is immediately saved without requiring further confirmation. If no value is shown on the right-hand display, then measurement failed. The measurement must be repeated.

## 4 Restoring welding standby mode

- Switch off the welding machine.
- Screw the gas nozzle onto the welding torch.
- Switch on the welding machine
- Insert the welding wire.

### 5.18.3 Power-saving mode (Standby)

You can activate the power-saving mode by either pressing the push-button for a prolonged time or by setting a parameter in the machine configuration menu (time-controlled power-saving mode).

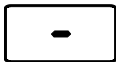

When power-saving mode is activated, the machine displays show the horizontal digit in the centre of the display only.

Pressing any operating element (e.g. tapping the torch trigger) deactivates power-saving mode and the machine is ready for welding again.

- See 4.4 Machine control – Operating elements chapter
- See 5.18 Machine configuration menu chapter

## 6 Maintenance, care and disposal



### DANGER



#### Improper maintenance and testing

The equipment may only be cleaned, repaired or tested by specialist, skilled persons! A skilled person is one who, due to training, knowledge and experience, is able to recognise the dangers that can occur during testing of this equipment as well as possible subsequent damage and who is able to implement the required safety procedures.

- Complete all tests given in the chapter below!
- Only put the equipment back into operation following a successful test.



#### Risk of injury from electric shock!

**Cleaning machines that are not disconnected from the mains can lead to serious injuries!**

- Disconnect the machine completely from the mains.
- Remove the mains plug!
- Wait for 4 minutes until the capacitors have discharged!

Repair and maintenance work may only be performed by qualified authorised personnel; otherwise the right to claim under warranty is void. In all service matters, always consult the dealer who supplied the machine. Return deliveries of defective equipment subject to warranty may only be made through your dealer. When replacing parts, use only original spare parts. When ordering spare parts, please quote the machine type, serial number and item number of the machine, as well as the type designation and item number of the spare part.

### 6.1 General

When used in the specified environmental conditions and under normal operating conditions, this machine is largely maintenance-free and requires a minimum of care.

There are some points, which should be observed, to guarantee fault-free operation of your welding machine. Among these are regular cleaning and checking as described below, depending on the pollution level of the environment and the length of time the unit is in use.

### 6.2 Maintenance work, intervals

#### 6.2.1 Daily maintenance tasks

- Check that all connections and wearing parts are hand-tight and tighten if necessary.
- Check that all screw and plug connections and replaceable parts are secured correctly, tighten if necessary.
- Remove any spatter.
- Clean the wire feed rollers on a regular basis (depending on the degree of soiling).

##### 6.2.1.1 Visual inspection

- Check hose package and power connections for exterior damage and replace or have repaired by specialist staff as necessary!
- Mains supply lead and its strain relief
- Gas tubes and their switching equipment (solenoid valve)
- Other, general condition

##### 6.2.1.2 Functional test

- Check correct mounting of the wire spool.
- Welding current cables (check that they are fitted correctly and secured)
- Gas cylinder securing elements
- Operating, message, safety and adjustment devices (Functional test)

## 6.2.2 Monthly maintenance tasks

### 6.2.2.1 Visual inspection

- Casing damage (front, rear and side walls)
- Wheels and their securing elements
- Transport elements (strap, lifting lugs, handle)
- Check coolant tubes and their connections for impurities

### 6.2.2.2 Functional test

- Selector switches, command devices, emergency stop devices, voltage reducing devices, message and control lamps
- Check that the wire guide elements (inlet nipple, wire guide tube) are fitted securely.

## 6.2.3 Annual test (inspection and testing during operation)

 **The welding machine may only be tested by competent, capable persons!** A capable person is one who, because of his training, knowledge and experience, is able to recognise the dangers that can occur while testing welding power sources as well as possible subsequent damage and who is able to implement the required safety procedures.

 **For more information refer to the "Warranty registration" brochure supplied and our information regarding warranty, maintenance and testing at [www.ewm-group.com](http://www.ewm-group.com)!**

A periodic test according to IEC 60974-4 "Periodic inspection and test" has to be carried out. In addition to the regulations on testing given here, the relevant local laws and regulations must also be observed.

## 6.3 Disposing of equipment

 **Proper disposal!**  
**The machine contains valuable raw materials, which should be recycled, and electronic components, which must be disposed of.**



- **Do not dispose of in household waste!**
- **Observe the local regulations regarding disposal!**

### 6.3.1 Manufacturer's declaration to the end user

- According to European provisions (guideline 2002/96/EG of the European Parliament and the Council of January, 27th 2003), used electric and electronic equipment may no longer be placed in unsorted municipal waste. It must be collected separately. The symbol depicting a waste container on wheels indicates that the equipment must be collected separately.  
This machine is to be placed for disposal or recycling in the waste separation systems provided for this purpose.
- According to German law (law governing the distribution, taking back and environmentally correct disposal of electric and electronic equipment (ElektroG) from 16.03.2005), used machines are to be placed in a collection system separate from unsorted municipal waste. The public waste management utilities (communities) have created collection points at which used equipment from private households can be disposed of free of charge.
- Information about giving back used equipment or about collections can be obtained from the respective municipal administration office.
- EWM participates in an approved waste disposal and recycling system and is registered in the Used Electrical Equipment Register (EAR) under number WEEE DE 57686922.
- In addition to this, returns are also possible throughout Europe via EWM sales partners.

## 6.4 Meeting the requirements of RoHS

We, EWM AG Mündersbach, hereby confirm that all products supplied by us which are affected by the RoHS Directive, meet the requirements of the RoHS (Directive 2011/65/EU).

## 7 Rectifying faults

All products are subject to rigorous production checks and final checks. If, despite this, something fails to work at any time, please check the product using the following flowchart. If none of the fault rectification procedures described leads to the correct functioning of the product, please inform your authorised dealer.

### 7.1 Checklist for rectifying faults



**The correct machine equipment for the material and process gas in use is a fundamental requirement for perfect operation!**

Legend	Symbol	Description
	↘	Fault/Cause
	✘	Remedy

#### Coolant error/no coolant flowing

- ↘ Insufficient coolant flow
  - ✘ Check coolant level and refill if necessary
- ↘ Air in the coolant circuit
  - ✘ Vent coolant circuit - See 7.5 Vent coolant circuit chapter

#### Wire feed problems

- ↘ Contact tip blocked
  - ✘ Clean, spray with anti-spatter spray and replace if necessary
- ↘ Setting the spool brake - See 5.10.2.5 Spool brake setting chapter
  - ✘ Check settings and correct if necessary
- ↘ Setting pressure units - See 5.10.2.4 Inching the wire electrode chapter
  - ✘ Check settings and correct if necessary
- ↘ Worn wire rolls
  - ✘ Check and replace if necessary
- ↘ Wire feed motor without supply voltage (automatic cutout triggered by overloading)
  - ✘ Reset triggered fuse (rear of the power source) by pressing the key button
- ↘ Kinked hose packages
  - ✘ Extend and lay out the torch hose package
- ↘ Wire guide core or spiral is dirty or worn
  - ✘ Clean core or spiral; replace kinked or worn cores

#### Functional errors

- ↘ Machine control without displaying the signal lights after switching on
  - ✘ Phase failure > check mains connection (fuses)
- ↘ No welding performance
  - ✘ Phase failure > check mains connection (fuses)
- ↘ Various parameters cannot be set
  - ✘ Entry level is blocked, disable access lock - See 5.16 Protecting welding parameters from unauthorised access chapter
- ↘ Connection problems
  - ✘ Make control lead connections and check that they are fitted correctly.
- ↘ Loose welding current connections
  - ✘ Tighten power connections on the torch and/or on the workpiece
  - ✘ Tighten contact tip correctly

## 7.2 Error messages

 **A welding machine error is indicated by an error code being displayed (see table) on the display on the machine control.**

**In the event of a machine error, the power unit is shut down.**

 **The display of possible error numbers depends on the machine version (interfaces/functions).**

- Document machine errors and inform service staff as necessary.
- If multiple errors occur, these are displayed in succession.



Error	Category			Possible cause	Remedy
	a)	b)	c)		
Error 1 (Ov.Vol)	-	-	x	Mains overvoltage	Check the mains voltages and compare with the connection voltages of the welding machine
Error 2 (Un.Vol)	-	-	x	Mains undervoltage	
Error 3 (Temp)	x	-	-	Welding machine excess temperature	Allow the machine to cool down (mains switch to "1")
Error 4 (Water)	x	x	-	Low coolant level	Top off the coolant Leak in the coolant circuit > rectify the leak and top off the coolant Coolant pump is not working > check excess current trigger on air cooling unit
Error 5 (Wi.Spe)	x	-	-	Wire feeder/speedometer error	Check the wire feeder speedometer is not issuing a signal, M3.51 defective > inform Service
Error 6 (gas)	x	-	-	Shielding gas error	Check shielding gas supply (for machines with shielding gas monitoring)
Error 7 (Se.Vol)	-	-	x	Secondary excess voltage	Inverter error > inform Service
Error 8 (no PE)	-	-	x	Earth fault between welding wire and earth line	Separate the connection between the welding wire and casing or an earthed object
Error 9 (fast stop)	x	-	-	Fast cut-out triggered by BUSINT X11 or RINT X12	Rectify error on robot
Error 10 (no arc)	-	x	-	Arc break triggered by BUSINT X11 or RINT X12	Check wire feeding
Error 11 (no ign)	-	x	-	Ignition fault after 5 s triggered by BUSINT X11 or RINT X12	Check wire feeding
Error 14 (no DV)	-	x	-	Wire feeder not detected. Control cable not connected.	Check cable connection
				Incorrect ID numbers assigned during operation with multiple wire feeders.	Check assignment of ID numbers
Error 15 (DV2?)	-	x	-	Wire feeder 2 not detected. Control cable not connected.	Check cable connection
Error 16 (VRD)	-	-	x	VRD (open circuit voltage reduction error)	Inform Service
Error 18 (Wf.Sl.)	x	-	-	Auxiliary drive/speedometer error	Check auxiliary drive tachogenerator not issuing signals. M3.51 defective > inform Service
Error 17 (WF. Ov.)	-	x	x	Wire feed mechanism overcurrent detection	Check the wire feeding

Error	Category			Possible cause	Remedy
	a)	b)	c)		
Error 18 (WF. Sl.)	-	x	x	No speedometer signal from second wire feeder (slave drive)	Check the connection and particularly the speedometer of the second wire feeder (slave drive).
Error 56 (no Pha)	-	-	x	Mains phase failure	Check mains voltages

### Legend for categories (error reset)

a) The error message will disappear once the error has been rectified.

b) The error message can be reset by pressing a key button:

Welding machine control	Key button
RC1 / RC2	
Expert	
CarExpert / Progress (M3.11)	
alpha Q / Concept / Basic / Basic S / Synergic / Synergic S / Progress (M3.71) / Picomig 305	not possible

c) The error message can only be reset by switching the machine off and on again.

The shielding gas error (Err 6) can be reset by pressing the "Welding parameters" key button.

## 7.3 Resetting JOBS (welding tasks) to the factory settings

All customised welding parameters that are stored will be replaced by the factory settings.

### 7.3.1 Resetting a single JOB

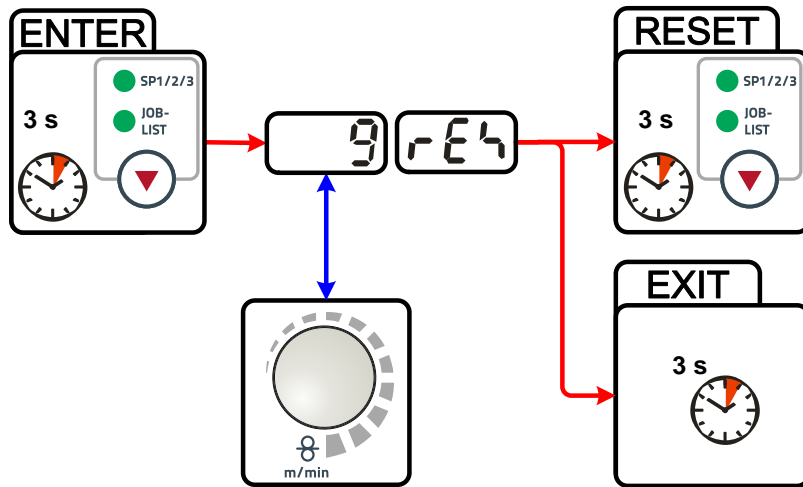

Figure 7-1

Display	Setting/selection
	<b>RESET to factory settings</b> The RESET will be done after pressing the button. The menu will be ended when no changes are done after 3 sec.
	<b>JOB-number (example)</b> The shown JOB will be set to ex works.



## 7.3.2 Resetting all JOBs

**JOBs 1–128 and 170–256 will be reset.**  
**Custom JOBs 129–169 are maintained.**

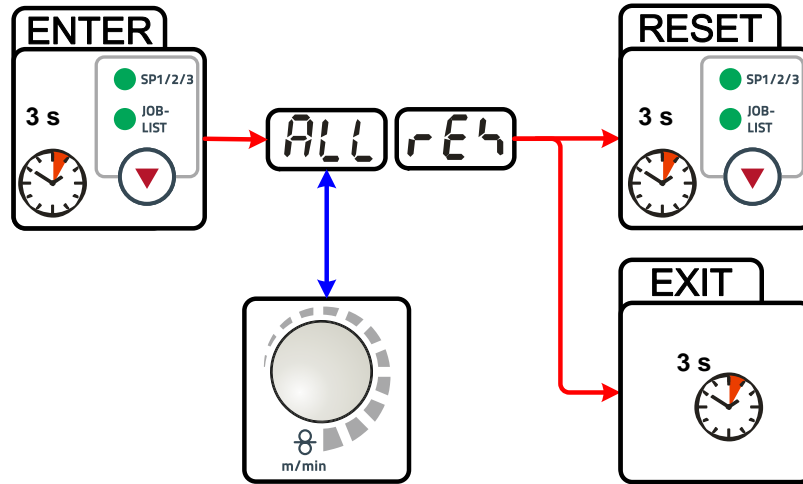

Figure 7-2

Display	Setting/selection
	<b>RESET to factory settings</b> The RESET will be done after pressing the button. The menu will be ended when no changes are done after 3 sec.

## 7.4 General operating problems

### 7.4.1 Interface for automated welding

#### **WARNING**



**No function of the external interrupt equipment (emergency stop switch)!**  
 If the emergency stop circuit has been set up using an external interrupt equipment connected to the interface for automated welding, the machine must be configured for this setup. If this is not observed, the power source will ignore the external interrupt equipment and will not shut down!

- Remove jumper 1 on the T320/1, M320/1 or M321 PCB!

### 7.5 Vent coolant circuit

- Coolant tank and quick connect coupling of coolant supply and return are only fitted in machines with water cooling.**
- To vent the cooling system always use the blue coolant connection, which is located as deep as possible inside the system (close to the coolant tank)!**

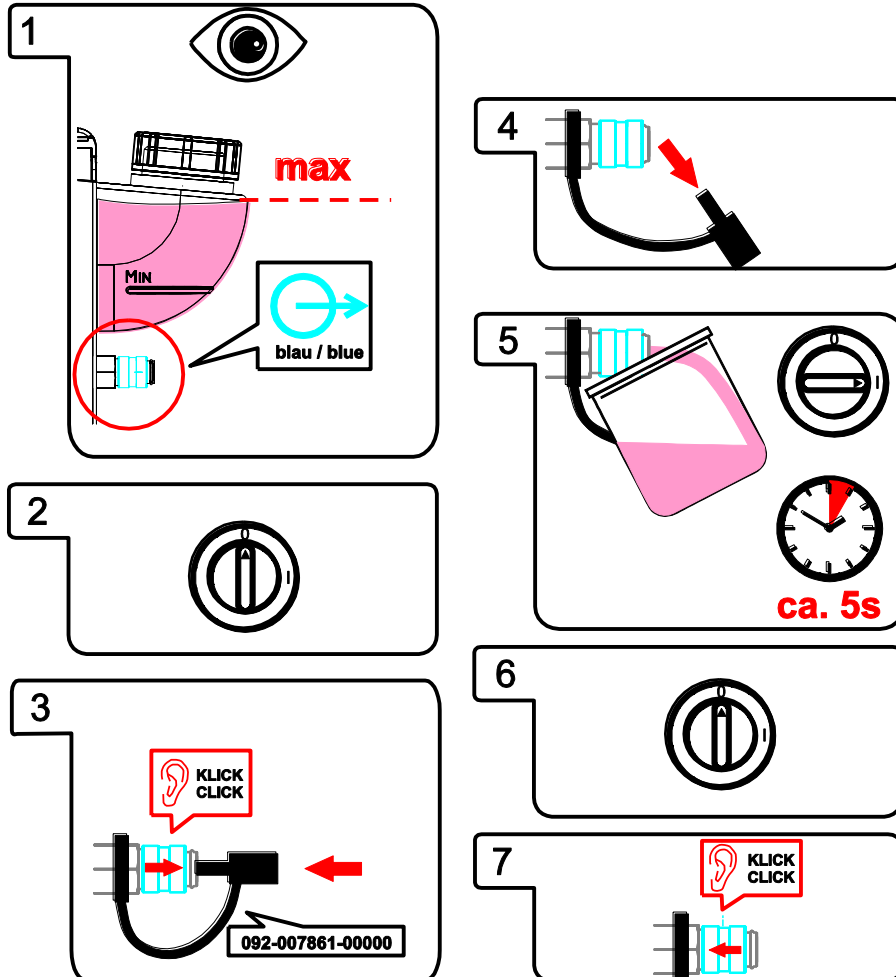

Figure 7-3

## 8 Technical data

 *Performance specifications and guarantee only in connection with original spare and replacement parts!*

### 8.1 Phoenix 401 Progress FKW

	MIG/MAG	TIG	MMA
Setting range for welding current	5 A–400 A		
Setting range for welding voltage	14.3 V–34.0 V	10.2 V–26.0 V	20.2 V–36.0 V
Duty cycle at 40 °C			
100%	400 A		
Load cycle	10 min (60% DC $\Delta$ 6 min welding, 4 min pause)		
Open circuit voltage	79 V		
Mains voltage (tolerances)	3 x 400 V (-25% to +20%)		
Frequency	50/60 Hz		
Mains fuse (safety fuse, slow-blow)	3 x 32 A		
Mains connection lead	H07RN-F4G6		
Maximum connected load	17.5 kVA	13.5 kVA	18.5 kVA
Recommended generator rating	25.0 kVA		
cos $\phi$ /efficiency	0.99/90 %		
Insulation class/protection classification	H/IP 23		
Ambient temperature*	-25 °C to +40 °C		
Machine/welding torch cooling	Fan/gas or water		
Cooling capacity at 1 l/min	1500 W		
Max. flow rate	5 l/min		
Max. coolant outlet pressure	3.5 bar		
Max. tank capacity	12 l		
Workpiece lead	70 mm <sup>2</sup>		
Wire feed speed	0.5 m/min. to 25 m/min.		
Standard roller installation	1.0 mm + 1.2 mm (for steel wire)		
Wire feed type	4 rolls (37 mm)		
Wire spool diameter	Standardized wire spools up to 300 mm		
Welding torch connection	Euro torch connector		
EMC class	A		
Dimensions L x W x H in mm	1100 x 455 x 950		
Weight	121.5 kg		
Constructed to standard	IEC 60974-1, -2, -5, -10 S / C E		

 *\*Ambient temperature depends on coolant! Observe the coolant temperature range for the welding torch cooling!*

## 8.2 Phoenix 501 Progress FKW

	MIG/MAG	TIG	MMA
Setting range for welding current	5 A–500 A		
Setting range for welding voltage	14.3 V–39.0 V	10.2 V–30.0 V	20.2 V–40.0 V
Duty cycle at 40 °C			
60%	500 A		
100%	430 A		
Load cycle	10 min (60% DC $\triangle$ 6 min welding, 4 min pause)		
Open circuit voltage	79 V		
Mains voltage (tolerances)	3 x 400 V (-25% to +20%)		
Frequency	50/60 Hz		
Mains fuse (safety fuse, slow-blow)	3 x 32 A		
Mains connection lead	H07RN-F4G6		
Maximum connected load	24.9 kVA	19.3 kVA	25.6 kVA
Recommended generator rating	34.6 kVA		
cos $\phi$ /efficiency	0.99/90%		
Insulation class/protection classification	H/IP 23		
Ambient temperature*	-25 °C to +40 °C		
Machine/welding torch cooling	Fan/gas or water		
Cooling capacity at 1 l/min	1500 W		
Max. flow rate	5 l/min		
Max. coolant outlet pressure	3.5 bar		
Max. tank capacity	12 l		
Workpiece lead	95 mm <sup>2</sup>		
Wire feed speed	0.5 m/min. to 25 m/min.		
Standard roller installation	1.0 mm + 1.2 mm (for steel wire)		
Wire feed type	4 rolls (37 mm)		
Wire spool diameter	Standardized wire spools up to 300 mm		
Welding torch connection	Euro torch connector		
EMC class	A		
Dimensions L x W x H in mm	1100 x 455 x 950		
Weight	124.5 kg		
Constructed to standard	IEC 60974-1, -2, -5, -10 ☑ / ☑ ☑		



**\*Ambient temperature depends on coolant! Observe the coolant temperature range for the welding torch cooling!**

## 9 Accessories

 *Performance-dependent accessories like torches, workpiece leads, electrode holders or intermediate hose packages are available from your authorised dealer.*

### 9.1 General accessories

Type	Designation	Item no.
AK300	Wire spool adapter K300	094-001803-00001
TYP 1	Frost protection tester	094-014499-00000
KF 23E-10	Coolant (-10 °C), 9.3 l	094-000530-00000
KF 23E-200	Coolant (-10 °C), 200 litres	094-000530-00001
KF 37E-10	Coolant (-20 °C), 9.3 l	094-006256-00000
KF 37E-200	Coolant (-20 °C), 200 l	094-006256-00001
DMDIN TN 200B AR/MIX 35L	Manometer pressure regulator	094-000009-00000
5POLE/CEE/32A/M	Machine plug	094-000207-00000
HOSE BRIDGE UNI	Tube bridge	092-007843-00000

### 9.2 Remote control/connecting and extension cable

#### 9.2.1 7-pole connection

Type	Designation	Item no.
R40 7POL	Remote control, 10 programs	090-008088-00000
R50 7POL	Remote control, all welding machine functions can be set directly at the workplace	090-008776-00000
FRV 7POL 0.5 m	Extension/connecting cable	092-000201-00004
FRV 7POL 5 m	Extension/connecting cable	092-000201-00003
FRV 7POL 10 m	Extension/connecting cable	092-000201-00000
FRV 7POL 20 m	Extension/connecting cable	092-000201-00001
FRV 7POL 25M	Extension/connecting cable	092-000201-00007

#### 9.2.2 19-pole connection

Type	Designation	Item no.
R10 19POL	Remote control	090-008087-00000
RG10 19POL 5M	Remote control to set the wire speed and welding voltage correction	090-008108-00000
R20 19POL	Program changeover remote control	090-008263-00000
RA5 19POL 5M	Remote control e.g. connection cable	092-001470-00005
RA10 19POL 10M	Remote control e.g. connection cable	092-001470-00010
RA20 19POL 20M	Remote control e.g. connection cable	092-001470-00020
RV5M19 19POLE 5M	Extension cable	092-000857-00000
RV5M19 19POL 10M	Extension cable	092-000857-00010
RV5M19 19POL 15M	Extension cable	092-000857-00015
RV5M19 19POL 20M	Extension cable	092-000857-00020

## 9.3 Options

Type	Designation	Item no.
ON LB Wheels 160x40MM	Retrofit option for locking brake for machine wheels	092-002110-00000
ON Holder Gas Bottle <50L	Holding plate for gas cylinders smaller than 50 litres	092-002151-00000
ON Shock Protect	Ram protection retrofit option	092-002154-00000
ON Hose/FR Mount	Optional holder for tubes and remote control for machines without pivot support	092-002116-00000
ON Filter T/P	Retrofit option contamination filter for air inlet	092-002092-00000
ON Tool Box	Retrofit option tool box	092-002138-00000

## 9.4 Computer communication

Type	Designation	Item no.
PC300.Net	PC300.Net welding parameter software kit incl. cable and SECINT X10 USB interface	090-008777-00000
FRV 7POL 5 m	Extension/connecting cable	092-000201-00003
FRV 7POL 10 m	Extension/connecting cable	092-000201-00000
FRV 7POL 20 m	Extension/connecting cable	092-000201-00001
QDOC9000 V2.0	Set consisting of interface, documentation software, connection lead	090-008713-00000

## 10 Replaceable parts

### CAUTION



**Damage due to the use of non-genuine parts!**

**The manufacturer's warranty becomes void if non-genuine parts are used!**

- Only use system components and options (power sources, welding torches, electrode holders, remote controls, spare parts and replacement parts, etc.) from our range of products!
- Only insert and lock accessory components into the relevant connection socket when the machine is switched off.

### 10.1 Wire feed rollers

#### 10.1.1 Wire feed rollers for steel wire

Type	Designation	Item no.
FE 4R 0.6 MM/0.023 INCH LIGHT PINK	Drive roll set, 37 mm, 4 rolls, V-groove for steel, stainless steel and brazing	092-002770-00006
FE 4R 0.8 MM/0.03 INCH WHITE	Drive roll set, 37 mm, 4 rolls, V-groove for steel, stainless steel and brazing	092-002770-00008
FE 4R 1.0 MM/0.04 INCH BLUE	Drive roll set, 37 mm, 4 rolls, V-groove for steel, stainless steel and brazing	092-002770-00010
FE 4R 1.2 MM/0.045 INCH RED	Drive roll set, 37 mm, 4 rolls, V-groove for steel, stainless steel and brazing	092-002770-00012
FE 4R 1.4 MM/0.052 INCH GREEN	Drive roll set, 37 mm, 4 rolls, V-groove for steel, stainless steel and brazing	092-002770-00014
FE 4R 1.6 MM/0.06 INCH BLACK	Drive roll set, 37 mm, 4 rolls, V-groove for steel, stainless steel and brazing	092-002770-00016
FE 4R 2.0 MM/0.08 INCH GREY	Drive roll set, 37 mm, 4 rolls, V-groove for steel, stainless steel and brazing	092-002770-00020
FE 4R 2.4 MM/0.095 INCH BROWN	Drive roll set, 37 mm, 4 rolls, V-groove for steel, stainless steel and brazing	092-002770-00024
FE 4R 2.8 MM/0.11 INCH LIGHT GREEN	Drive roll set, 37 mm, 4 rolls, V-groove for steel, stainless steel and brazing	092-002770-00028
FE 4R 3.2 MM/0.12 INCH VIOLET	Drive roll set, 37 mm, 4 rolls, V-groove for steel, stainless steel and brazing	092-002770-00032

## 10.1.2 Wire feed rollers for aluminium wire

Type	Designation	Item no.
AL 4R 0.8 MM/0.03 INCH WHITE	Drive roll set, 37 mm, for aluminium	092-002771-00008
AL 4R 1.0 MM/0.04 INCH BLUE	Drive roll set, 37 mm, for aluminium	092-002771-00010
AL 4R 1.2 MM/0.045 INCH RED	Drive roll set, 37 mm, for aluminium	092-002771-00012
AL 4R 1.6 MM/0.06 INCH BLACK	Drive roll set, 37 mm, for aluminium	092-002771-00016
AL 4R 2.0 MM/0.08 INCH GREY/YELLOW	Drive roll set, 37 mm, for aluminium	092-002771-00020
AL 4R 2.4 MM/0.095 INCH BROWN/YELLOW	Drive roll set, 37 mm, for aluminium	092-002771-00024
AL 4R 2.8 MM/0.110 INCH LIGHT GREEN/YELLOW	Drive roll set, 37 mm, for aluminium	092-002771-00028
AL 4R 3.2 MM/0.125 INCH VIOLET/YELLOW	Drive roll set, 37 mm, for aluminium	092-002771-00032

## 10.1.3 Wire feed rollers for cored wire

Type	Designation	Item no.
FUEL 4R 0.8 MM/0.03 INCH WHITE/ORANGE	Drive roll set, 37 mm, 4 rolls, V-groove/knurled for flux cored wire	092-002848-00008
FUEL 4R 1.0 MM/0.04 INCH BLUE/ORANGE	Drive roll set, 37 mm, 4 rolls, V-groove/knurled for flux cored wire	092-002848-00010
FUEL 4R 1.2 MM/0.045 INCH RED/ORANGE	Drive roll set, 37 mm, 4 rolls, V-groove/knurled for flux cored wire	092-002848-00012
FUEL 4R 1.4 MM/0.052 INCH GREEN/ORANGE	Drive roll set, 37 mm, 4 rolls, V-groove/knurled for flux cored wire	092-002848-00014
FUEL 4R 1.6 MM/0.06 INCH BLACK/ORANGE	Drive roll set, 37 mm, 4 rolls, V-groove/knurled for flux cored wire	092-002848-00016
FUEL 4R 2.0 MM/0.08 INCH GREY/ORANGE	Drive roll set, 37 mm, 4 rolls, V-groove/knurled for flux cored wire	092-002848-00020
FUEL 4R 2.4 MM/0.095 INCH BROWN/ORANGE	Drive roll set, 37 mm, 4 rolls, V-groove/knurled for flux cored wire	092-002848-00024

## 10.1.4 Wire guide

Type	Designation	Item no.
SET DRAHTFUERUNG	Wire guide set	092-002774-00000
ON WF 2,0-3,2MM EFEED	Retrofitting option, wire guide for 2.0–3.2 mm wires, eFeed drive	092-019404-00000
SET IG 4x4 1.6mm BL	Inlet guide set	092-002780-00000
GUIDE TUBE L105	Guide tube	094-006051-00000
CAPTUB L108 D1,6	Capillary tube	094-006634-00000
CAPTUB L105 D2,0/2,4	Capillary tube	094-021470-00000



## 11 Appendix A

### 11.1 JOB-List

Massivdraht					Solidwire					forceArc®					forceArc puls®									
Material	Gas	Inch Ø	.030 .040 .045 .060				Material	Gas	Inch Ø	.030 .040 .045 .060														
			0,8	1,0	1,2	1,6				0,8	1,0	1,2	1,6											
					Job-Nr.										Job-Nr.									
SG2/3 G3/4 Si1	CO <sub>2</sub> -100 / C1		1	3	4	5	SG2/3 G3/4 Si1	Ar-90/CO <sub>2</sub> -10 M20	190	254	255	256	CrNi	Ar-97,5/CO <sub>2</sub> -2,5 M12										
	Ar-82/CO <sub>2</sub> -18 M21	6	8	9	10	Ar-82/CO <sub>2</sub> -18 M21		189	179	180	181													
	Ar-90/CO <sub>2</sub> -10 M20	11	13	14	15	Ar-97,5/CO <sub>2</sub> -2,5 M12			251	252	253													
CrNi	Ar-97,5/ CO <sub>2</sub> -2,5/ M12	318 / 1.4576	26	27	28	29	AlMg	Ar-100 / I1					AlSi	Ar-100 / I1										
		307 / 1.4370	30	31	32	33													247	248				
		308 / 1.4316	34	35	36	37													249	250				
		316 / 1.4430	38	39	40	41													Al99	Ar-100 / I1			245	246
		Duplex 2209 / 1.4462	42	43	44	45																		
Ar-He-CO <sub>2</sub>	46	47	48	49																				
NiCr	625	Ar-70/He-30 / I3	271	272			rootArc®					rootArc puls®												
		Ar-He-CO <sub>2</sub> Ar-He-H <sub>2</sub> -CO <sub>2</sub>	275	276																				
CuSi	Ar-100 / I1	98	99	100	101	SG2/3 G3/4 Si1	CO <sub>2</sub> -100 / C1																	
CuAl	Ar-100 / I1	106	107	108	109													204	205					
CuSi Lüten / Brazing	Ar-100 / I1	Ar97,5/CO <sub>2</sub> -2,5 M12	114	115	116	117		Ar-82/CO <sub>2</sub> -18 M21																
			110	111	112	113													206	207				
CuAl Lüten / Brazing	Ar-100 / I1	Ar97,5/CO <sub>2</sub> -2,5 M12	122	123	124	125	additional																	
			118	119	120	121	SP1	129																
AlMg	Ar-100 / I1	Ar-70/He-30 / I3	74	75	76	77	SP2	130																
			78	79	80	81	SP3	131																
AlSi	Ar-100 / I1	Ar-70/He-30 / I3	82	83	84	85	GMAW non synergic <8m / min	187																
			86	87	88	89	GMAW non synergic >8m / min	188																
Al99	Ar-100 / I1	Ar-70/He-30 / I3	90	91	92	93	Fugen / gouging	126																
			94	95	96	97	WIG / TIG	127																
Fülldraht					Flux-Cored																			
Material	Gas	Inch Ø	.030 .040 .045 .060				Material	Gas	Inch Ø	.030 .040 .045 .060														
			0,8	1,0	1,2	1,6				0,8	1,0	1,2	1,6											
					Job-Nr.										Job-Nr.									
G3Si1 / G4Si1 Metal	Ar-82/CO <sub>2</sub> -21 M21		235	237	238	239	G3Si1 / G4Si1 Rutil / Basic	Ar-82/CO <sub>2</sub> -21 M21		240	242	243	244	CrNi Metal	Ar-97,5/CO <sub>2</sub> -2,5 M12		229	230						
CrNi Rutil / Basic	Ar-82/CO <sub>2</sub> -21 M21						CrNi Rutil / Basic	CO <sub>2</sub> -100 / C1				260	261											
CrNi Rutil / Basic	Ar-82/CO <sub>2</sub> -21 M21							CO <sub>2</sub> -100 / C1				233	234											
															WPQR									
															$E = \frac{P}{v_s}$									
															<b>000</b> kW: cm / sec = kJ/cm kW: mm / sec = kJ/mm									
															Stahl mild steel Edelstahl stainless steel Aluminium aluminium									

Art.-Nr.: 094-021066-00500

Figure 11-1

## 12 Appendix B

### 12.1 Overview of EWM branches

#### Headquarters

**EWM AG**  
Dr. Günter-Henle-Straße 8  
56271 Mündersbach · Germany  
Tel: +49 2680 181-0 · Fax: -244  
www.ewm-group.com · info@ewm-group.com

#### Technology centre

**EWM AG**  
Forststraße 7-13  
56271 Mündersbach · Germany  
Tel: +49 2680 181-0 · Fax: -144  
www.ewm-group.com · info@ewm-group.com



#### Production, Sales and Service

**EWM AG**  
Dr. Günter-Henle-Straße 8  
56271 Mündersbach · Germany  
Tel: +49 2680 181-0 · Fax: -244  
www.ewm-group.com · info@ewm-group.com

**EWM HIGH TECHNOLOGY (Kunshan) Ltd.**  
10 Yuanshan Road, Kunshan · New & Hi-tech Industry Development Zone  
Kunshan City · Jiangsu · Post code 215300 · People's Republic of China  
Tel: +86 512 57867-188 · Fax: -182  
www.ewm.cn · info@ewm.cn · info@ewm-group.cn

**EWM HIGHTEC WELDING s.r.o.**  
9. května 718 / 31  
407 53 Jirřkov · Czech Republic  
Tel: +420 412 358-551 · Fax: -504  
www.ewm-jirikov.cz · info@ewm-jirikov.cz

#### Sales and Service Germany

**EWM AG**  
Sales and Technology Centre  
Grünauer Fenn 4  
14712 Rathenow · Tel: +49 3385 49402-0 · Fax: -20  
www.ewm-rathenow.de · info@ewm-rathenow.de

**EWM AG**  
Rudolf-Winkel-Straße 7-9  
37079 Göttingen · Tel: +49 551-3070713-0 · Fax: -20  
www.ewm-goettingen.de · info@ewm-goettingen.de

**EWM AG**  
Sachsstraße 28  
50259 Pulheim · Tel: +49 2234 697-047 · Fax: -048  
www.ewm-pulheim.de · info@ewm-pulheim.de

**EWM AG**  
August-Horch-Straße 13a  
56070 Koblenz · Tel: +49 261 963754-0 · Fax: -10  
www.ewm-koblenz.de · info@ewm-koblenz.de

**EWM AG**  
Eiserfelder Straße 300  
57080 Siegen · Tel: +49 271 3878103-0 · Fax: -9  
www.ewm-siegen.de · info@ewm-siegen.de

**EWM HIGHTEC WELDING GmbH**  
Sales and Technology Centre  
Draisstraße 2a  
69469 Weinheim · Tel: +49 6201 84557-0 · Fax: -20  
www.ewm-weinheim.de · info@ewm-weinheim.de

**EWM Schweißtechnik Handels GmbH**  
Karlsdorfer Straße 43  
88069 Tettang · Tel: +49 7542 97998-0 · Fax: -29  
www.ewm-tettang.de · info@ewm-tettang.de

**EWM Schweißtechnik Handels GmbH**  
Pffaffensteig 17  
89143 Blaubeuren · Tel: +49 7344 9191-75 · Fax: -77  
www.ewm-blaubeuren.de · info@ewm-blaubeuren.de

**EWM Schweißtechnik Handels GmbH**  
Heinkelstraße 8  
89231 Neu-Ulm · Tel: +49 731 7047939-0 · Fax: -15  
www.ewm-neu-ulm.de · info@ewm-neu-ulm.de

#### Sales and Service International

**EWM HIGH TECHNOLOGY (Kunshan) Ltd.**  
10 Yuanshan Road, Kunshan · New & Hi-tech Industry Development Zone  
Kunshan City · Jiangsu · Post code 215300 · People's Republic of China  
Tel: +86 512 57867-188 · Fax: -182  
www.ewm.cn · info@ewm.cn · info@ewm-group.cn

**EWM HIGHTEC WELDING GmbH**  
Wiesenstraße 27b  
4812 Pinsdorf · Austria · Tel: +43 7612 778 02-0 · Fax: -20  
www.ewm-austria.at · info@ewm-austria.at

#### Liaison office Turkey

**EWM AG Türkiye İrtibat Bürosu**  
İkitelli OSB Mah. · Marmara Sanayi Sitesi P Blok Apt. No: 44  
Küçükçekmece / İstanbul Türkiye  
Tel: +90 212 494 32 19  
www.ewm-istanbul.com.tr · info@ewm-istanbul.com.tr

**EWM HIGHTEC WELDING UK Ltd.**  
Unit 2B Coopies Way · Coopies Lane Industrial Estate  
Morpeth · Northumberland · NE61 6JN · Great Britain  
Tel: +44 1670 505875 · Fax: -514305  
www.ewm-morpeth.co.uk · info@ewm-morpeth.co.uk

**EWM HIGHTEC WELDING Sales s.r.o. / Prodejní a poradenské centrum**  
Tyrřova 2106  
256 01 Beneřov u Prahy · Czech Republic  
Tel: +420 317 729-517 · Fax: -712  
www.ewm-benesov.cz · info@ewm-benesov.cz

Plants

Branches

Liaison office

● More than 400 EWM sales partners worldwide