



Welding machine

Saturn 301 KGE (M1.02 / M2.20 / M2.40)

Saturn 351 KGE (M1.02 / M2.20 / M2.40)

099-004968-EW501

27.09.2011

Register now!
For your benefit
Jetzt Registrieren
und Profitieren!

www.ewm-group.com



General instructions

CAUTION



Read the operating instructions!

The operating instructions provide an introduction to the safe use of the products.

- Read the operating instructions for all system components!
- Observe accident prevention regulations!
- Observe all local regulations!
- Confirm with a signature where appropriate.

NOTE



In the event of queries on installation, commissioning, operation or special conditions at the installation site, or on usage, please contact your sales partner or our customer service department on +49 2680 181-0.

A list of authorised sales partners can be found at www.ewm-group.com.

Liability relating to the operation of this equipment is restricted solely to the function of the equipment. No other form of liability, regardless of type, shall be accepted. This exclusion of liability shall be deemed accepted by the user on commissioning the equipment.

The manufacturer is unable to monitor whether or not these instructions or the conditions and methods are observed during installation, operation, usage and maintenance of the equipment.

An incorrectly performed installation can result in material damage and injure persons as a result. For this reason, we do not accept any responsibility or liability for losses, damages or costs arising from incorrect installation, improper operation or incorrect usage and maintenance or any actions connected to this in any way.

1 Contents

1	Contents	3
2	Safety instructions	6
2.1	Notes on the use of these operating instructions	6
2.2	Explanation of icons	7
2.3	General	8
2.4	Transport and installation	12
2.4.1	Lifting by crane	13
2.5	Ambient conditions	14
2.5.1	In operation	14
2.5.2	Transport and storage	14
3	Intended use	15
3.1	Applications	15
3.1.1	MIG/MAG standard welding	15
3.2	Documents which also apply	15
3.2.1	Warranty	15
3.2.2	Declaration of Conformity	15
3.2.3	Welding in environments with increased electrical hazards	15
3.2.4	Service documents (spare parts and circuit diagrams)	15
4	Machine description – quick overview	16
4.1	Front view	16
4.2	Rear view	17
4.3	Machine control – Operating elements	18
4.3.1	Welding machine control M1.02	18
4.3.1.1	Internal operating elements	19
4.3.1.2	Setting the operating point (welding output)	20
4.3.1.3	Welding parameter ignition time "tZn" diagram	20
4.3.2	M2.20 welding machine control	21
4.3.2.1	Setting the operating point (welding output)	23
4.3.2.2	Setting the operating mode and runtime parameters	23
4.3.2.3	Setting the expert parameters	24
4.3.2.4	Explanation of symbols	24
4.3.2.5	Welding parameter ignition time "tZn" diagram	25
4.3.3	M2.40 welding machine control	26
4.3.3.1	Select JOB number (welding task)	28
4.3.3.2	Setting the operating point (welding output)	29
4.3.3.3	Setting the wire correction	29
4.3.3.4	Setting the operating mode and runtime parameters	30
4.3.3.5	Setting the expert parameters	31
4.3.3.6	Explanation of symbols	31
4.3.3.7	Welding parameter ignition time "tZn" diagram	32
5	Design and function	33
5.1	General	33
5.2	Transport and installation	34
5.3	Workpiece lead, general	34
5.4	Machine cooling	34
5.5	Mains connection	35
5.5.1	Mains configuration	35
5.6	Welding torch and workpiece line connection	36
5.7	Shielding gas supply	37
5.7.1	Connecting the shielding gas supply	37
5.7.2	Setting the shielding gas quantity	39

5.8	Inserting the wire electrode	40
5.8.1	Inserting the wire spool.....	40
5.8.2	Changing the wire feed rollers.....	41
5.8.3	Inching the wire electrode.....	42
5.8.4	Spool brake setting.....	43
5.9	MIG/MAG functional sequences / operating modes	44
5.9.1	Explanation of signs and functions	44
5.9.2	Non-latched operation	45
5.9.3	Latched operation	46
5.9.4	Spot welding	47
5.9.5	Interval	48
5.9.6	MIG/MAG automatic cut-out	48
6	Maintenance, care and disposal	49
6.1	General.....	49
6.2	Maintenance work, intervals.....	49
6.2.1	Daily maintenance tasks.....	49
6.2.2	Monthly maintenance tasks	49
6.2.3	Annual test (inspection and testing during operation)	49
6.3	Maintenance work	50
6.4	Disposing of equipment.....	50
6.4.1	Manufacturer's declaration to the end user	50
6.5	Meeting the requirements of RoHS.....	50
7	Rectifying faults.....	51
7.1	Customer checklist.....	51
7.2	Check the machine type setting.....	52
7.2.1	Setting the machine type	52
7.3	Resetting the control (Reset all).....	53
8	Technical data.....	54
8.1	Saturn 301, 351 KG	54
9	Accessories	55
9.1	Options.....	55
9.2	General accessories	55
10	Replaceable parts.....	56
10.1	Wire feed rollers	56
10.1.1	Wire feed rollers for steel wire	56
10.1.2	Wire feed rollers for aluminium wire	56
10.1.3	Wire feed rollers for cored wire.....	56
10.1.4	Conversion sets	57
11	Appendix A.....	58
11.1	Setting instructions.....	58
11.1.1	Saturn 301	58
11.1.2	Saturn 351	59
12	Appendix B.....	60
12.1	Overview of EWM branches.....	60

2 Safety instructions

2.1 Notes on the use of these operating instructions



DANGER

Working or operating procedures which must be closely observed to prevent imminent serious and even fatal injuries.

- Safety notes include the "DANGER" keyword in the heading with a general warning symbol.
- The hazard is also highlighted using a symbol on the edge of the page.



WARNING

Working or operating procedures which must be closely observed to prevent serious and even fatal injuries.

- Safety notes include the "WARNING" keyword in the heading with a general warning symbol.
- The hazard is also highlighted using a symbol in the page margin.



CAUTION

Working or operating procedures which must be closely observed to prevent possible minor personal injury.

- The safety information includes the "CAUTION" keyword in its heading with a general warning symbol.
- The risk is explained using a symbol on the edge of the page.

CAUTION

Working and operating procedures which must be followed precisely to avoid damaging or destroying the product.

- The safety information includes the "CAUTION" keyword in its heading without a general warning symbol.
- The hazard is explained using a symbol at the edge of the page.

NOTE

Special technical points which users must observe.

- Notes include the "NOTE" keyword in the heading without a general warning symbol.

Instructions and lists detailing step-by-step actions for given situations can be recognised via bullet points, e.g.:

- Insert the welding current lead socket into the relevant socket and lock.

2.2 Explanation of icons

Symbol	Description
	Press
	Do not press
	Turn
	Switch
	Switch off machine
	Switch on machine
	ENTER (enter the menu)
	NAVIGATION (Navigating in the menu)
	EXIT (Exit the menu)
	Time display (example: wait 4s/press)
	Interruption in the menu display (other setting options possible)
	Tool not required/do not use
	Tool required/use

2.3 General

DANGER



Electric shock!

Welding machines use high voltages which can result in potentially fatal electric shocks and burns on contact. Even low voltages can cause you to get a shock and lead to accidents.

- Do not touch any live parts in or on the machine!
- Connection cables and leads must be free of faults!
- Switching off alone is not sufficient!
- Place welding torch and stick electrode holder on an insulated surface!
- The unit should only be opened by specialist staff after the mains plug has been unplugged!
- Only wear dry protective clothing!
- Wait for 4 minutes until the capacitors have discharged!



Electromagnetic fields!

The power source may cause electrical or electromagnetic fields to be produced which could affect the correct functioning of electronic equipment such as IT or CNC devices, telecommunication lines, power cables, signal lines and pacemakers.

- Observe the maintenance instructions! (see Maintenance and Testing chapter)
- Unwind welding leads completely!
- Shield devices or equipment sensitive to radiation accordingly!
- The correct functioning of pacemakers may be affected (obtain advice from a doctor if necessary).



Do not carry out any unauthorised repairs or modifications!

To avoid injury and equipment damage, the unit must only be repaired or modified by specialist, skilled persons!

The warranty becomes null and void in the event of unauthorised interference.

- Appoint only skilled persons for repair work (trained service personnel)!

WARNING



Risk of accidents if these safety instructions are not observed!

Non-observance of these safety instructions is potentially fatal!

- Carefully read the safety information in this manual!
- Observe the accident prevention regulations in your country.
- Inform persons in the working area that they must observe the regulations!



Risk of injury due to radiation or heat!

Arc radiation results in injury to skin and eyes.

Contact with hot workpieces and sparks results in burns.

- Use welding shield or welding helmet with the appropriate safety level (depending on the application)!
- Wear dry protective clothing (e.g. welding shield, gloves, etc.) according to the relevant regulations in the country in question!
- Protect persons not involved in the work against arc beams and the risk of glare using safety curtains!

 **WARNING****Explosion risk!**

Apparently harmless substances in closed containers may generate excessive pressure when heated.

- Move containers with inflammable or explosive liquids away from the working area!
- Never heat explosive liquids, dusts or gases by welding or cutting!

**Smoke and gases!**

Smoke and gases can lead to breathing difficulties and poisoning. In addition, solvent vapour (chlorinated hydrocarbon) may be converted into poisonous phosgene due to the ultraviolet radiation of the arc!

- Ensure that there is sufficient fresh air!
- Keep solvent vapour away from the arc beam field!
- Wear suitable breathing apparatus if appropriate!

**Fire hazard!**

Flames may arise as a result of the high temperatures, stray sparks, glowing-hot parts and hot slag produced during the welding process.

Stray welding currents can also result in flames forming!

- Check for fire hazards in the working area!
- Do not carry any easily flammable objects such as matches or lighters.
- Keep appropriate fire extinguishing equipment to hand in the working area!
- Thoroughly remove any residue of flammable substances from the workpiece before starting welding.
- Only continue work on welded workpieces once they have cooled down.
Do not allow to come into contact with flammable material!
- Connect welding leads correctly!

 **CAUTION****Noise exposure!**

Noise exceeding 70 dBA can cause permanent hearing damage!

- Wear suitable ear protection!
- Persons located within the working area must wear suitable ear protection!

CAUTION**Obligations of the operator!**

The respective national directives and laws must be observed for operation of the machine!

- National implementation of the framework directive (89/391/EEG), as well as the associated individual directives.
- In particular, directive (89/655/EEG), on the minimum regulations for safety and health protection when staff members use equipment during work.
- The regulations regarding work safety and accident prevention for the respective country.
- Setting up and operating the machine according to IEC 60974-9.
- Check at regular intervals that users are working in a safety-conscious way.
- Regular checks of the machine according to IEC 60974-4.

CAUTION



Damage due to the use of non-genuine parts!

The manufacturer's warranty becomes void if non-genuine parts are used!

- Only use system components and options (power sources, welding torches, electrode holders, remote controls, spare parts and replacement parts, etc.) from our range of products!
- Only insert and lock accessory components into the relevant connection socket when the machine is switched off.



Damage to the machine due to stray welding currents!

Stray welding currents can destroy protective earth conductors, damage equipment and electronic devices and cause overheating of components leading to fire.

- Make sure all welding leads are securely connected and check regularly.
- Always ensure a proper and secure electrical connection to the workpiece!
- Set up, attach or suspend all conductive power source components like casing, transport vehicle and crane frames so they are insulated!
- Do not place any other electronic devices such as drillers or angle grinders, etc., on the power source, transport vehicle or crane frames unless they are insulated!
- Always put welding torches and electrode holders on an insulated surface when they are not in use!



Mains connection

Requirements for connection to the public mains network

High-performance machines can influence the mains quality by taking current from the mains network. For some types of machines, connection restrictions or requirements relating to the maximum possible line impedance or the necessary minimum supply capacity at the interface with the public network (Point of Common Coupling, PCC) can therefore apply. In this respect, attention is also drawn to the machines' technical data. In this case, it is the responsibility of the operator, where necessary in consultation with the mains network operator, to ensure that the machine can be connected.

CAUTION**EMC Machine Classification**

In accordance with IEC 60974-10, welding machines are grouped in two electromagnetic compatibility classes (see technical data):

Class A machines are not intended for use in residential areas where the power supply comes from the low-voltage public mains network. When ensuring the electromagnetic compatibility of class A machines, difficulties can arise in these areas due to interference not only in the supply lines but also in the form of radiated interference.

Class B machines fulfil the EMC requirements in industrial as well as residential areas, including residential areas connected to the low-voltage public mains network.

Setting up and operating

When operating arc welding systems, in some cases, electro-magnetic interference can occur although all of the welding machines comply with the emission limits specified in the standard. The user is responsible for any interference caused by welding.

In order to **evaluate** any possible problems with electromagnetic compatibility in the surrounding area, the user must consider the following: (see also EN 60974-10 Appendix A)

- Mains, control, signal and telecommunication lines
- Radios and televisions
- Computers and other control systems
- Safety equipment
- The health of neighbouring persons, especially if they have a pacemaker or wear a hearing aid
- Calibration and measuring equipment
- The immunity to interference of other equipment in the surrounding area
- The time of day at which the welding work must be carried out

Recommendations for reducing interference emission

- Mains connection, e.g. additional mains filter or shielding with a metal tube
- Maintenance of the arc welding equipment
- Welding leads should be as short as possible and run closely together along the ground
- Potential equalization
- Earthing of the workpiece. In cases where it is not possible to earth the workpiece directly, it should be connected by means of suitable capacitors.
- Shielding from other equipment in the surrounding area or the entire welding system

2.4 Transport and installation

WARNING



Incorrect handling of shielding gas cylinders!

Incorrect handling of shielding gas cylinders can result in serious and even fatal injury.

- Observe the instructions from the gas manufacturer and in any relevant regulations concerning the use of compressed air!
- Place shielding gas cylinders in the holders provided for them and secure with fixing devices.
- Avoid heating the shielding gas cylinder!

CAUTION



Risk of tipping!

There is a risk of the machine tipping over and injuring persons or being damaged itself during movement and set up. Tilt resistance is guaranteed up to an angle of 10° (according to EN 60974-A2).

- Set up and transport the machine on level, solid ground!
- Secure add-on parts using suitable equipment!
- Replace damaged wheels and their fixing elements!
- Fix external wire feed units during transport (avoid uncontrolled rotation)!



Damage due to supply lines not being disconnected!

During transport, supply lines which have not been disconnected (mains supply leads, control leads, etc.) may cause hazards such as connected equipment tipping over and injuring persons!

- Disconnect supply lines!

CAUTION



Equipment damage when not operated in an upright position!

The units are designed for operation in an upright position!

Operation in non-permissible positions can cause equipment damage.

- Only transport and operate in an upright position!

2.4.1 Lifting by crane

DANGER



Risk of injury during lifting by crane!

When lifting the equipment by crane, serious injuries can be inflicted by falling equipment or add-on units.

- Transport on all lifting lugs at the same time (see Fig. Lifting principle)!
- Ensure that there is an even load distribution! Only use ring chains or suspension ropes of the same length!
- Observe the lifting principle (see Fig.)!
- Remove all accessory components before lifting (e.g. shielding gas cylinders, tool boxes, wire feed units, etc.)!
- Avoid jerky movements when raising or lowering!
- Use shackles and load hooks of the appropriate size!

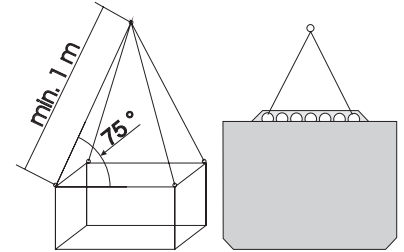

Fig. Lifting principle



Risk of injury due to unsuitable ring screws!

In case of improper use of ring screws or the use of unsuitable ring screws, persons can be seriously damaged by falling equipment or add-on components!

- The ring screw must be completely screwed in!
- The ring screw must be positioned flat onto and in full contact with the supporting surfaces!
- Check that the ring screws are securely fastened before use and check for any damage (corrosion, deformation)!
- Do not use or screw in damaged ring screws!
- Avoid lateral loading of the ring screws!

2.5 Ambient conditions

CAUTION



Installation site!

The machine must not be operated in the open air and must only be set up and operated on a suitable, stable and level base!

- The operator must ensure that the ground is non-slip and level, and provide sufficient lighting for the place of work.
- Safe operation of the machine must be guaranteed at all times.

CAUTION



Equipment damage due to dirt accumulation!

Unusually high quantities of dust, acid, corrosive gases or substances may damage the equipment.

- Avoid high volumes of smoke, vapour, oil vapour and grinding dust!
- Avoid ambient air containing salt (sea air)!



Non-permissible ambient conditions!

Insufficient ventilation results in a reduction in performance and equipment damage.

- Observe the ambient conditions!
- Keep the cooling air inlet and outlet clear!
- Observe the minimum distance of 0.5 m from obstacles!

2.5.1 In operation

Temperature range of the ambient air:

- -20 °C to +40 °C

Relative air humidity:

- Up to 50% at 40 °C
- Up to 90% at 20 °C

2.5.2 Transport and storage

Storage in an enclosed space, temperature range of the ambient air:

- -25 °C to +55 °C

Relative air humidity

- Up to 90% at 20 °C

3 Intended use

This machine has been manufactured according to the latest developments in technology and current regulations and standards. It must only be operated in line with the instructions on correct usage.

WARNING



Hazards due to improper usage!

Hazards may arise for persons, animals and material objects if the equipment is not used correctly. No liability is accepted for any damages arising from improper usage!

- The equipment must only be used in line with proper usage and by trained or expert staff!
- Do not modify or convert the equipment improperly!

3.1 Applications

3.1.1 MIG/MAG standard welding

Metal arc welding using a wire electrode whereby gas from an external source surrounds the arc and the molten pool to protect them from the atmosphere.

3.2 Documents which also apply

3.2.1 Warranty

NOTE



For further information, please see the accompanying supplementary sheets "Machine and Company Data, Maintenance and Testing, Warranty"!

3.2.2 Declaration of Conformity



The designated machine conforms to EC Directives and standards in terms of its design and construction:

- EC Low Voltage Directive (2006/95/EC),
- EC EMC Directive (2004/108/EC),

This declaration shall become null and void in the event of unauthorised modifications, improperly conducted repairs, non-observance of the deadlines for the repetition test and / or non-permitted conversion work not specifically authorised by the manufacturer.

The original copy of the declaration of conformity is enclosed with the unit.

3.2.3 Welding in environments with increased electrical hazards



In compliance with IEC / DIN EN 60974, VDE 0544 the machines can be used in environments with an increased electrical hazard.

3.2.4 Service documents (spare parts and circuit diagrams)

DANGER



Do not carry out any unauthorised repairs or modifications!

To avoid injury and equipment damage, the unit must only be repaired or modified by specialist, skilled persons!

The warranty becomes null and void in the event of unauthorised interference.

- Appoint only skilled persons for repair work (trained service personnel)!

Original copies of the circuit diagrams are enclosed with the unit.

Spare parts can be obtained from the relevant authorised dealer.

4 Machine description – quick overview

4.1 Front view

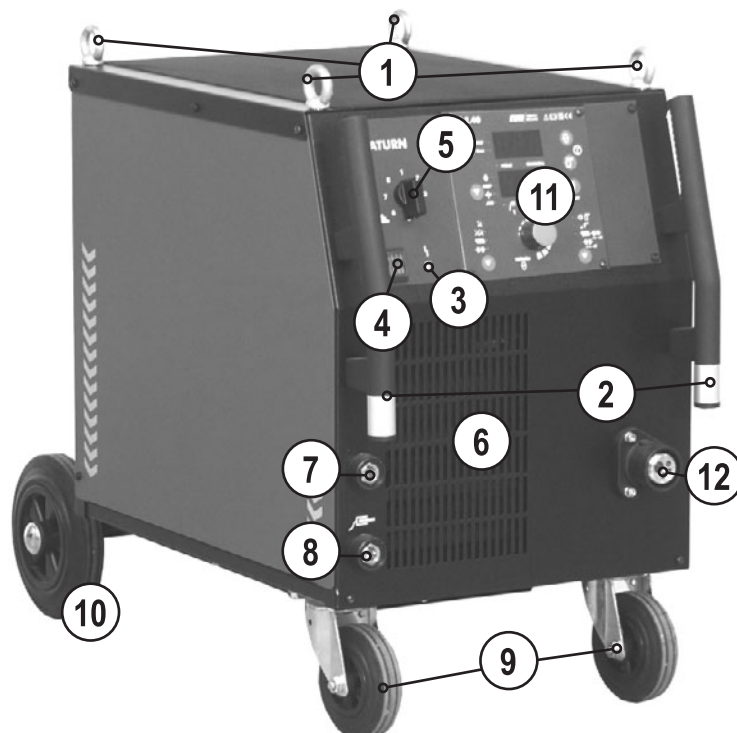

Figure 4-1

Item	Symbol	Description
1		Lifting lug
2		Carrying handle
3		Signal light, Functional error On when excess temperature detected
4		Main switch, machine on/off
5		Welding voltage step switch To set the welding voltage
6		Cooling air inlet
7		Connection socket, workpiece lead "Hard" choke tapping
8		Connection socket, workpiece lead "Medium" choke tapping
9		Wheels, guide castors
10		Wheels, fixed castors
11		Machine control See Machine control – operating elements chapter
12		Central connection for welding torch (Euro) Integrated welding current, shielding gas and torch trigger

4.2 Rear view

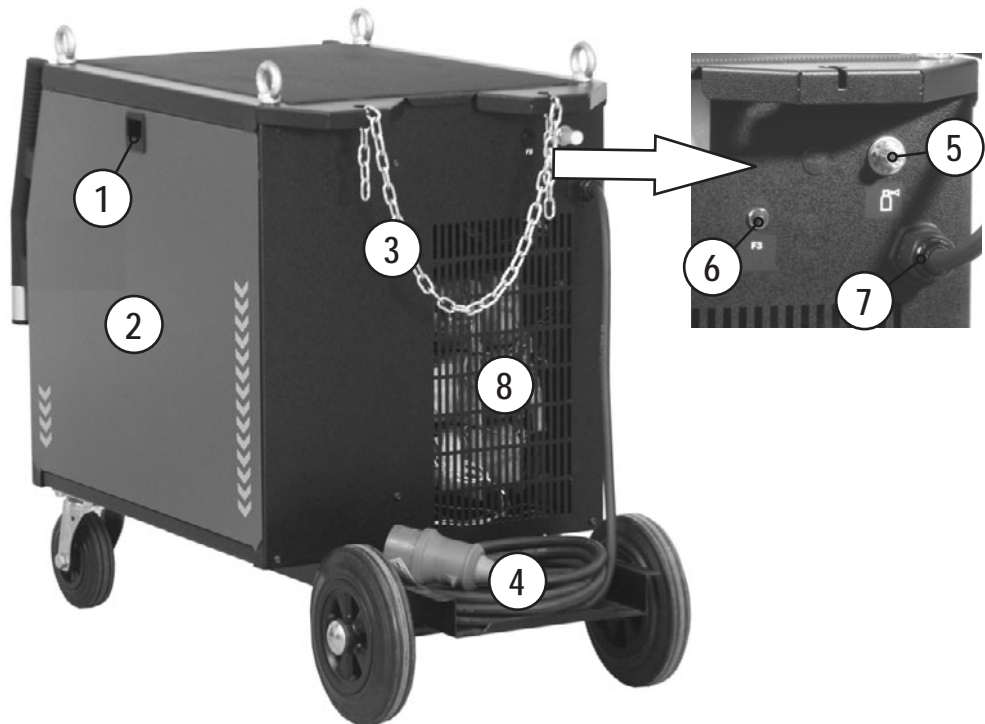

Figure 4-2

Item	Symbol	Description
1		Wire feed unit cover lock
2		Cover for wire feed unit and operating elements
3		Securing elements for shielding gas cylinder (strap/chain)
4		Bracket for shielding gas cylinder
5		Connecting nipple G $\frac{1}{4}$, shielding gas connection
6		Key button, Automatic cutout Wire feed motor supply voltage fuse (press to reset a triggered fuse)
7		Mains connection cable
8		Cooling air outlet

4.3 Machine control – Operating elements

4.3.1 Welding machine control M1.02

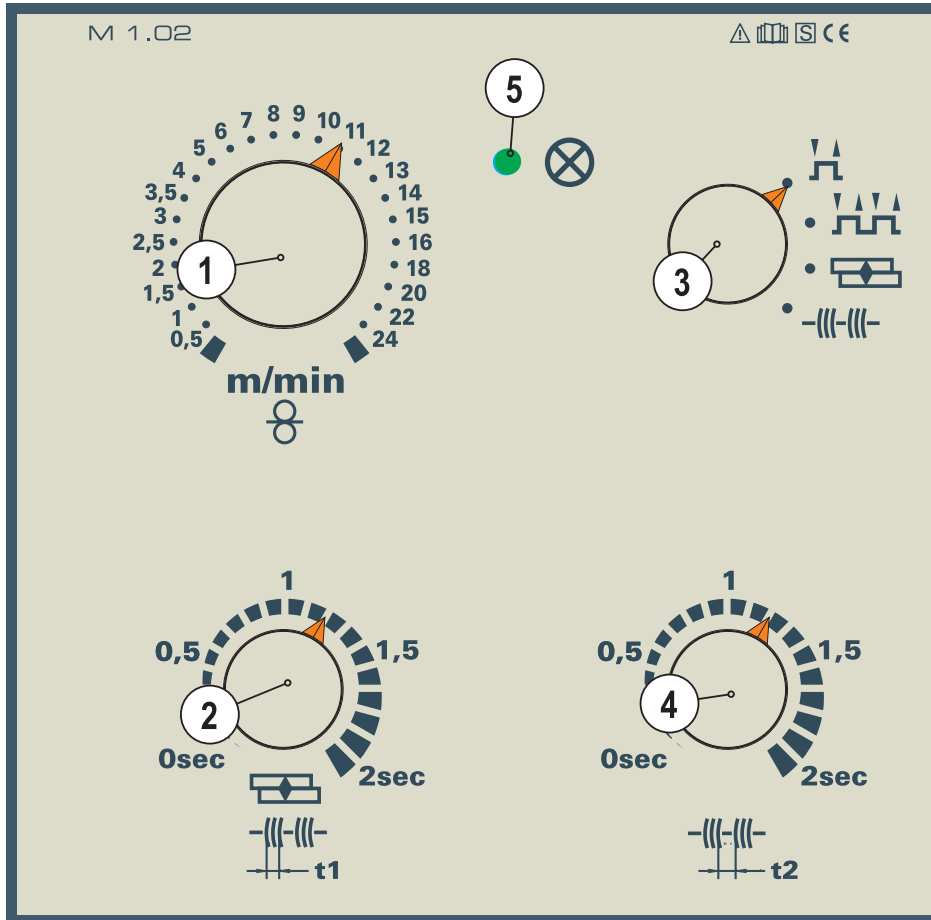

Figure 4-3

Item	Symbol	Description
1		Rotary dial, Wire speed setting Infinite adjustment of the wire speed.
2		Rotary dial, Spot and interval times Infinite adjustment of the welding time (0-2s) in "Spots and interval" operating mode
3		"Operating mode" selector switch Changeover between non-latched, latched, spot, interval
4		Rotary dial, Pause time Infinite adjustment of the pause time (0–2s) in "Interval" operating mode
5		Ready for operation signal light Signal light on when the machine is switched on and ready for operation

4.3.1.1 Internal operating elements

NOTE

The maximum possible machine configuration is given in the text description. If necessary, the optional connection may need to be retrofitted (see "Accessories" chapter).

- Unlock the right-hand cover on the machine.
- Tilt the cover forwards, then remove upwards.

There are other operating elements for parameter setting on the machine.

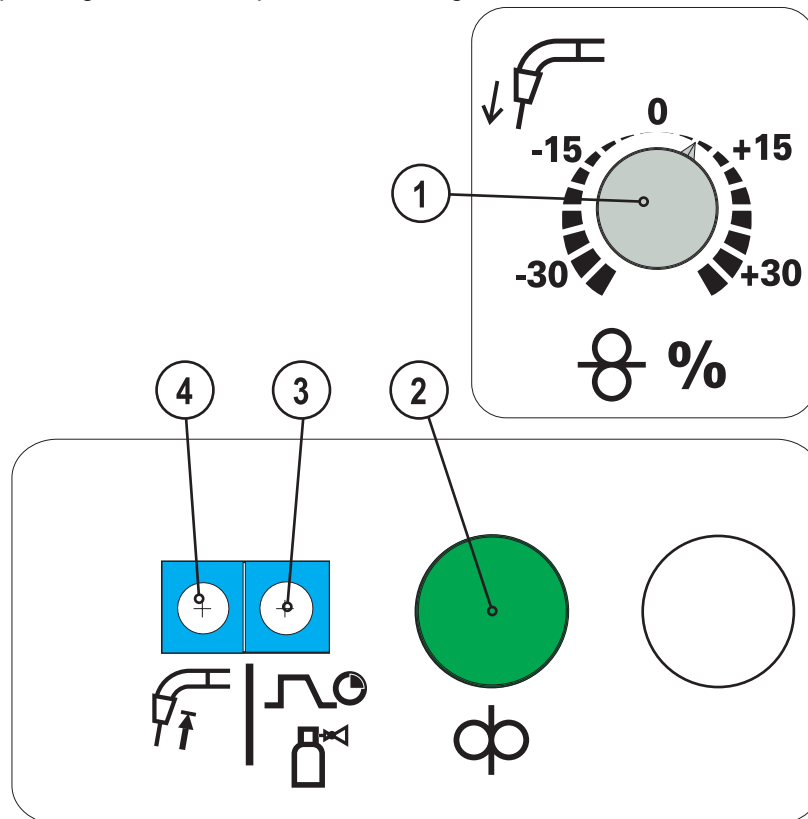

Figure 4-4

All details in percent relate to the values stored in the characteristics.

Item	Symbol	Description
1		Rotary dial, Wire creep (optional) +/- 30%
2		Key Button, Wire inching Currentless wire inching
3		"Gas post-flow time" trimmer Setting range 0.2-10 s
4		Trimmer, Burn-back +/- 50%

4.3.1.2 Setting the operating point (welding output)

This control works according to the twin-knob operation principle. To set the operating point, only the wire speed and the welding voltage need to be set according to the material and the electrode diameter.

Operating element	Action	Result
		Wire speed setting
		Welding voltage setting

4.3.1.3 Welding parameter ignition time "tZn" diagram

NOTE



In the ignition time, the wire feed continues to run at creep speed after the arc is ignited; the ignition behaviour is improved with the optimum setting.

The process described below is always used if there is a pause between welding processes of not less than 1.5 seconds.

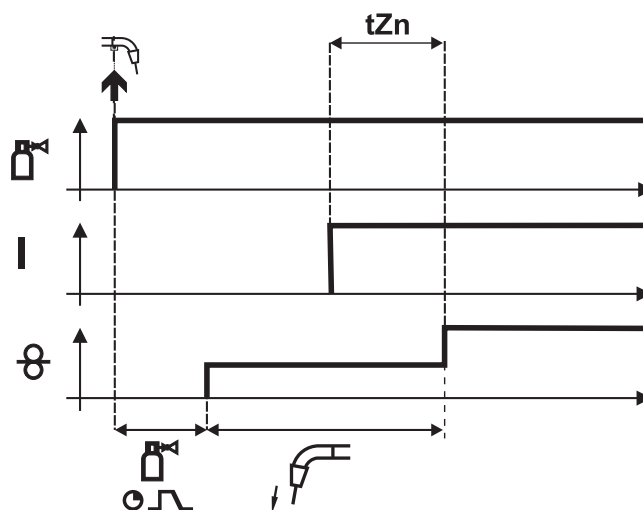

Figure 4-5

Legend with an explanation of symbols can be found in the MIG/MAG function sequences / operating modes chapter.

4.3.2 M2.20 welding machine control

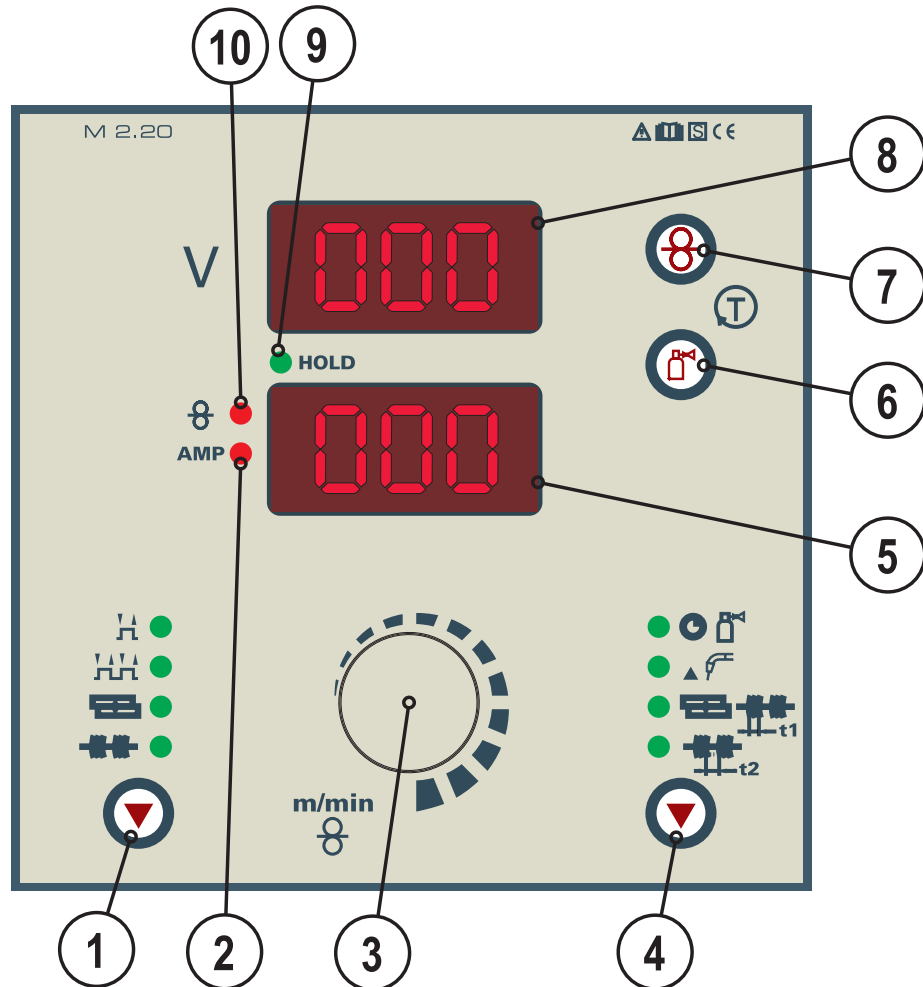





Figure 4-6

Item	Symbol	Description
1		Key button, Operating mode Non-latched Latched MIG spots (parameter selection t1 is carried out using the "Runtime parameters" button, setting on the "Rotary transducer". Interval (parameter selection, t1 = pulse time, t2 = pulse pause, carried out using "Runtime parameter" button, setting on the "Rotary transducer".
2	AMP	Current signal light Lights when the current is shown on the display.
3		Rotary dial, Wire speed/welding parameter setting Continuous adjustment of the wire speed or welding current and setting of runtime parameters such as gas post-flows, wire burn-back, etc.
4		"Runtime parameters" button The parameters are set on the rotary transducer Gas post-flow time (0.0 s to 10.0 s) Wire burn-back (-50% to +50%) Spot time / pulse time (0.1 s to 5.0 s) Pulse pause (0.1 s to 2.0 s)
5		Lower display Display of wire feed speed, welding current and runtime parameters.

Item	Symbol	Description
6		Button, Gas test The welding voltage and wire feed remain off when testing and setting the gas flow. Pressing the key button once causes shielding gas to flow for approx. 25 seconds. The button can be pressed again at any time to cancel the process.
7		Button, Wire inching For inching the wire electrode when changing the wire spool (speed = 6.0 m/min, constant). The welding wire is inched into the tube package with the current off and without gas being expelled. This ensures a high degree of safety for the welder by preventing accidental ignition of the arc.
8		Upper, display Displays welding voltage or person who designated the runtime parameters
9	HOLD	Signal light, HOLD Lit: Display shows the last parameters used for welding. Not lit: Display shows the setpoint values or current values during welding.
10		Signal light, Wire speed Lights when the wire speed is shown on the display.

4.3.2.1 Setting the operating point (welding output)

This control works according to the twin-knob operation principle. To set the operating point, only the wire speed and the welding voltage need to be set according to the material and the electrode diameter.

Operating element	Action	Result
		Wire speed setting
		Welding voltage setting

4.3.2.2 Setting the operating mode and runtime parameters

NOTE

The parameter values set are preset in the JOB and can be modified if necessary.

Operating element	Action	Result
		Select operating mode: Non-latched Latched Spots Interval
		Select welding parameter: Set gas post-flow time "GnS" (0.0 s to 10.0 s) Set wire burn-back time "drb" (-50% to 50%) Spot/interval time "t1" (0.1 s to 5.0 s) Interval/pause "t2" (0.1 s to 2.0 s) The selected parameter is shown on the display
		Set the parameter chosen

4.3.2.3 Setting the expert parameters

NOTE

The parameter values set are preset in the JOB and can be modified if necessary.

Operating element	Action	Result
	1 x	Select expert parameters. The key combination must be pressed within 3 seconds.
	1 x	
	2 x	
	n x	Select expert parameters: Gas pre-flow time "GvS" (0 s to 10 s) Wire creep speed "On" 0.5 – 24 m/min Ignition time "tZn" (0 ms to 500 ms) The selected parameter is shown on the display.
		Set the parameter chosen.

4.3.2.4 Explanation of symbols

Symbol	Meaning
GnS	"GnS" - Gas post-flows
drb	"drb" - Wire burn-back
t1	"t1" - Spot time
t2	"t2" - Interval time
GvS	"GvS" - Gas pre-flows
On	"On" - Wire creep
tZn	"tZn" - Ignition time
tyP	"tyP" - Machine type (type table, see chapter "Rectifying faults")

4.3.2.5 Welding parameter ignition time "tZn" diagram

NOTE

 In the ignition time, the wire feed continues to run at creep speed after the arc is ignited; the ignition behaviour is improved with the optimum setting.

The process described below is always used if there is a pause between welding processes of not less than 1.5 seconds.

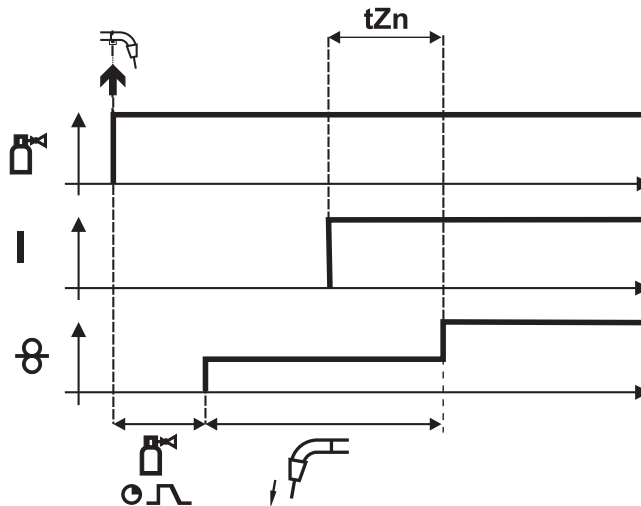

Figure 4-7

Legend with an explanation of symbols can be found in the MIG/MAG function sequences / operating modes chapter.

4.3.3 M2.40 welding machine control

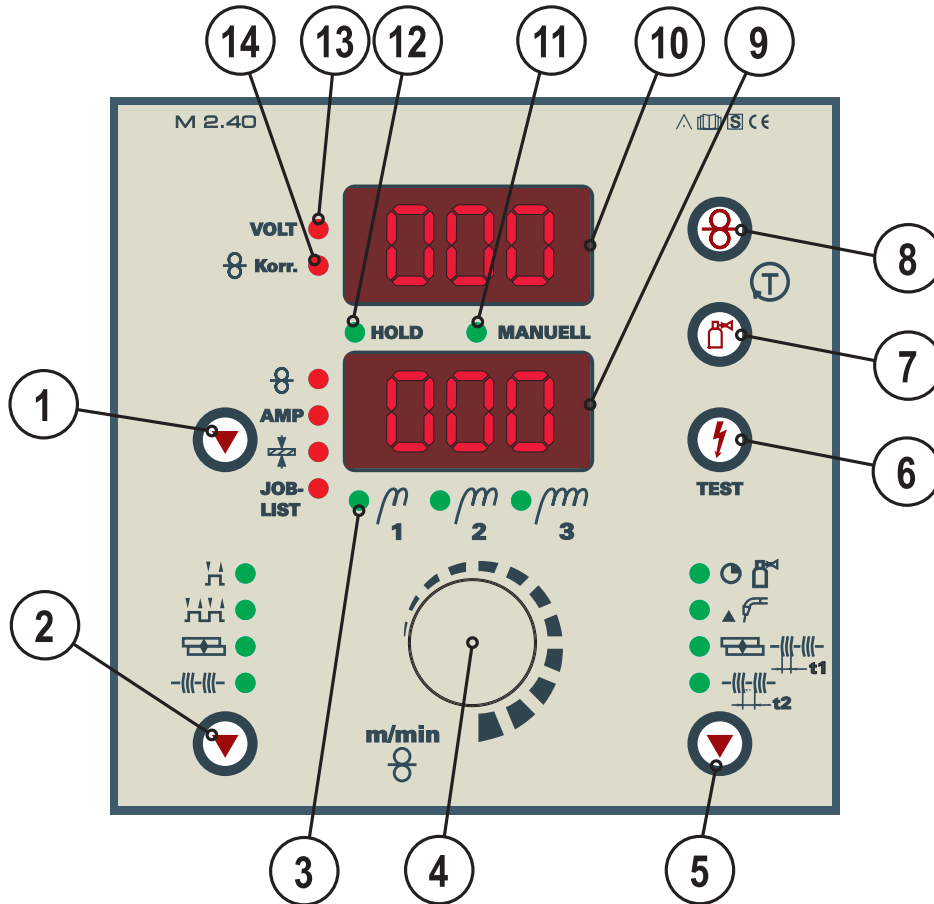

Figure 4-8

Item	Symbol	Description
1		Button, Welding task / operating point The parameters are set on the rotary transducer ♂ Wire speed display (m/min) AMP Welding current display (A) Sheet metal thickness display (mm) JOB-LIST Display and select the jobs (welding tasks, selection via job list). Change the JOBs by holding down the button (approx. 3 sec), LED flashes.
2		Key button, Operating mode Non-latched Latched MIG spots (parameter selection t1 is carried out using the "Runtime parameters" button, setting on the "Rotary transducer"). Interval (parameter selection, t1 = pulse time, t2 = pulse pause, carried out using "Runtime parameter" button, setting on the "Rotary transducer").
3		Signal light, Choke tapplings Depending on the machine design, there are two or three workpiece connection sockets on the welding machine (choke tapplings). The machine displays the recommended workpiece connection in JOB mode (see relevant images on the connection sockets). <ul style="list-style-type: none"> Choke tapping 1 (hard), workpiece lead connection socket Choke tapping 2 (medium), workpiece lead connection socket Choke tapping 3 (soft), workpiece lead connection socket

Item	Symbol	Description
4		Rotary dial, Wire speed / welding parameter setting Infinite adjustment of the wire speed or welding current, sheet metal thickness, JOB and runtime parameters such as gas post-flows, wire burn-back, etc.
5		"Runtime parameters" button The parameters are set on the rotary transducer <ul style="list-style-type: none"> Gas post-flow time (0.0 s to 10.0 s) Wire burn-back (-50% to +50%) Spot time / pulse time (0.1 s to 5.0 s) Pulse pause (0.1 s to 2.0 s)
6		Button, Test welding parameters Press the button and set the required welding voltage on the step switch at the same time (the open-circuit voltage will be shown in the upper display; the wire speed, welding current or panel thickness in the lower display).
7		Button, Gas test The welding voltage and wire feed remain off when testing and setting the gas flow. Pressing the key button once causes shielding gas to flow for approx. 25 seconds. The button can be pressed again at any time to cancel the process.
8		Button, Wire inching For inching the wire electrode when changing the wire spool (speed = 6.0 m/min, constant). The welding wire is inched into the tube package with the current off and without gas being expelled. This ensures a high degree of safety for the welder by preventing accidental ignition of the arc.
9		Lower display Display of wire feed speed, welding current, sheet metal thickness, JOB number and runtime parameters.
10		Upper display Display of the welding voltage, correction value for the wire speed or parameter designations for runtime parameters.
11	MANUELL	Signal light, MANUAL Signal light is on when the machine is not in JOB mode. All parameter settings are carried out "manually" by the user (JOB 0).
12	HOLD	Signal light, HOLD Lit: Display shows the last parameters used for welding. Not lit: Display shows the setpoint values or current values during welding.
13	VOLT	Signal light Voltage On when the welding voltage or open circuit voltage is displayed.
14		Signal light, Wire correction On when the correction value of the wire speed is being displayed.

4.3.3.1 Select JOB number (welding task)

This microprocessor-controlled control works according to the one-dial operation principle.

Only the gas type, material type and wire electrode diameter should be set as the JOB number on the control, as well as welding output via the step switch. This defines the welding task and the system specifies the optimum wire feed speed for the required operating point after the "Test button" is pressed. These settings are retained after the machine is switched off. After switching on again, the parameters previously set can be used to continue welding.

The user has the option to correct the wire feed speed according to the welding task or individual requirements.

The welding task setting can also be made using the two-dial operation principle, however. To do this, set the "JOB 0" (manual / no program) from the JOB list, the welding voltage on the step switch, and the wire speed on the rotary dial. Other parameters are set as described under "Using synergic mode".

Operating element	Action	Result
	X x	JOB-LIST Select "JOB". When the "JOB" LED lights, press and hold down the button.
	2 sec.	JOB-LIST "JOB" LED flashes.

The welder uses the filler material inserted and the connected shielding gas to select the JOB number according to the "JOB-LIST". The "JOB-LIST" is a sticker fixed near the wire feed drive unit.

		Set JOB number (0-24).
	1 x	Confirm selection.

ewm®		JOB-LIST				094-010488-00500			
Material	Gas	Ø Wire							
		0,8	1,0	1,2	1,6				
		Job-Nr.							
SG2/3 G3/4 Si1	CO ₂ 100	1	2	3	4				
	Ar82/18	5	6	7	8				
CrNi	Ar98/2	9	10	11	12				
AlMg	Ar100	13	14	15	16				
AlSi	Ar100	17	18	19	20				
Al99	Ar100	21	22	23	24				
Manuell / no program		0							

Figure 4-9

4.3.3.2 Setting the operating point (welding output)

NOTE

The operating point setting in JOB "0" (manual) is carried out as described in the chapter of the same name for control M2.4x. The following settings are therefore only intended for work in JOBS 1-24.

Operating element	Action	Result
		Select the parameter via which the welding output is to be set: using the panel thickness using the wire speed using the welding current
	 	Hold down the "TEST" button and at the same time set the operating point on the step switch. The display shows the required parameters and the open circuit voltage. If the "Volt" and "Wire feed correction" diodes are flashing, this indicates an error (e.g. short circuit between torch and workpiece, inductivity error, etc). To correct the error, press "TEST" again.

If the operating mode has already been selected, all the necessary settings will have been activated and welding can be started.

4.3.3.3 Setting the wire correction

The wire speed (arc length) can be modified using the wire correction if required.

Operating element	Action	Result
		Set the wire correction value

4.3.3.4 Setting the operating mode and runtime parameters

NOTE

The parameter values set are preset in the JOB and can be modified if necessary.

Operating element	Action	Result
	n x	Select operating mode: Non-latched Latched Spots Interval
	n x	Select welding parameter: Set gas post-flow time "GnS" (0.0 s to 10.0 s) Set wire burn-back time "drb" (-50% to 50%) Spot/interval time "t1" (0.1 s to 5.0 s) Interval/pause "t2" (0.1 s to 2.0 s) The selected parameter is shown on the display
		Set the parameter chosen

4.3.3.5 Setting the expert parameters

NOTE

The parameter values set are preset in the JOB and can be modified if necessary.

Operating element	Action	Result
	1 x	Select expert parameters. The key combination must be pressed within 3 seconds.
	1 x	
	2 x	
 	n x	Select expert parameters: Gas pre-flow time "GvS" (0 s to 10 s) Wire creep speed "On" 0.5 – 24 m/min Ignition time "tZn" (0 ms to 500 ms) The selected parameter is shown on the display.
		Set the parameter chosen.

4.3.3.6 Explanation of symbols

Symbol	Meaning
GnS	"GnS" - Gas post-flows
drb	"drb" - Wire burn-back
t1	"t1" - Spot time
t2	"t2" - Interval time
GvS	"GvS" - Gas pre-flows
Ein	"On" - Wire creep
tZn	"tZn" - Ignition time
tyP	"tyP" - Machine type (type table, see chapter "Rectifying faults")

4.3.3.7 Welding parameter ignition time "tZn" diagram

NOTE



In the ignition time, the wire feed continues to run at creep speed after the arc is ignited; the ignition behaviour is improved with the optimum setting.

The factory setting is that the ignition time is already optimally preset for various materials. The process described below is always used if there is a pause between welding processes of not less than 1.5 seconds.

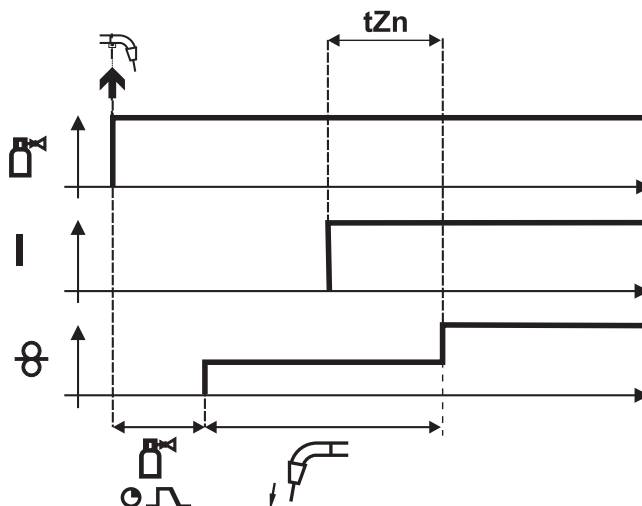

Figure 4-10

Legend with an explanation of symbols can be found in the MIG/MAG function sequences / operating modes chapter.

5 Design and function

5.1 General

WARNING



Risk of injury from electric shock!

Contact with live parts, e.g. welding current sockets, is potentially fatal!

- Follow safety instructions on the opening pages of the operating instructions.
- Commissioning may only be carried out by persons who have the relevant expertise of working with arc welding machines!
- Connection and welding leads (e.g. electrode holder, welding torch, workpiece lead, interfaces) may only be connected when the machine is switched off!

CAUTION



Risk of burns on the welding current connection!

If the welding current connections are not locked, connections and leads heat up and can cause burns, if touched!

- Check the welding current connections every day and lock by turning in clockwise direction, if necessary.



Risk of injury due to moving parts!

The wire feed units are equipped with moving parts, which can trap hands, hair, clothing or tools and thus injure persons!

- Do not reach into rotating or moving parts or drive components!
- Keep casing covers closed during operation!



Risk of injury due to welding wire escaping in an unpredictable manner!

Welding wire can be conveyed at very high speeds and, if conveyed incorrectly, may escape in an uncontrolled manner and injure persons!

- Before mains connection, set up the complete wire guide system from the wire spool to the welding torch!
- Remove the pressure rollers from the wire feed unit if no welding torch is fitted!
- Check wire guide at regular intervals!
- Keep all casing covers closed during operation!



Risk from electrical current!

If welding is carried out alternately using different methods and if a welding torch and an electrode holder remain connected to the machine, the open-circuit/welding voltage is applied simultaneously on all cables.

- The torch and the electrode holder should therefore always be placed on an insulated surface before starting work and during breaks.

CAUTION



Damage due to incorrect connection!

Accessory components and the power source itself can be damaged by incorrect connection!

- Only insert and lock accessory components into the relevant connection socket when the machine is switched off.
- Comprehensive descriptions can be found in the operating instructions for the relevant accessory components.
- Accessory components are detected automatically after the power source is switched on.



Using protective dust caps!

Protective dust caps protect the connection sockets and therefore the machine against dirt and damage.

- The protective dust cap must be fitted if there is no accessory component being operated on that connection.
- The cap must be replaced if faulty or if lost!

5.2 Transport and installation



CAUTION



Installation site!

The machine must not be operated in the open air and must only be set up and operated on a suitable, stable and level base!

- The operator must ensure that the ground is non-slip and level, and provide sufficient lighting for the place of work.
- Safe operation of the machine must be guaranteed at all times.

5.3 Workpiece lead, general



CAUTION



Risk of burns due to incorrect connection of the workpiece lead!

Paint, rust and dirt on the connection restrict the power flow and may lead to stray welding currents.

Stray welding currents may cause fires and injuries!

- Clean the connections!
- Fix the workpiece lead securely!
- Do not use structural parts of the workpiece as a return lead for the welding current!
- Take care to ensure faultless power connections!

5.4 Machine cooling

To obtain an optimal duty cycle from the power components, the following precautions should be observed:

- Ensure that the working area is adequately ventilated.
- Do not obstruct the air inlets and outlets of the machine.
- Do not allow metal parts, dust or other objects to get into the machine.

5.5 Mains connection

DANGER



Hazard caused by improper mains connection!

An improper mains connection can cause injuries or damage property!

- Only use machine with a plug socket that has a correctly fitted protective conductor.
- If a mains plug must be fitted, this may only be carried out by an electrician in accordance with the relevant national provisions or regulations (any phase sequence for three-phase machines)!
- Mains plug, socket and lead must be checked regularly by an electrician!
- When operating the generator always ensure it is earthed as stated in the operating instructions. The resulting network has to be suitable for operating devices according to protection class 1.

5.5.1 Mains configuration

NOTE



The machine may be connected to:

- a three-phase system with four conductors and an earthed neutral conductor
- a three-phase system with three conductors of which any one can be earthed, e.g. the outer conductor

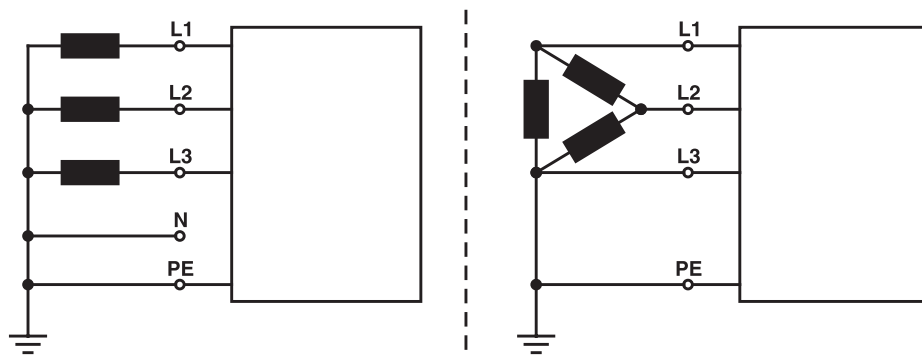

Figure 5-1

Legend

Item	Designation	Colour code
L1	Outer conductor 1	black
L2	Outer conductor 2	brown
L3	Outer conductor 3	grey
N	Neutral conductor	blue
PE	Protective conductor	green-yellow

CAUTION



Operating voltage - mains voltage!

The operating voltage shown on the rating plate must be consistent with the mains voltage, in order to avoid damage to the machine!

- For mains fuse protection, please refer to the "Technical data" chapter!

- Insert mains plug of the switched-off machine into the appropriate socket.

5.6 Welding torch and workpiece line connection

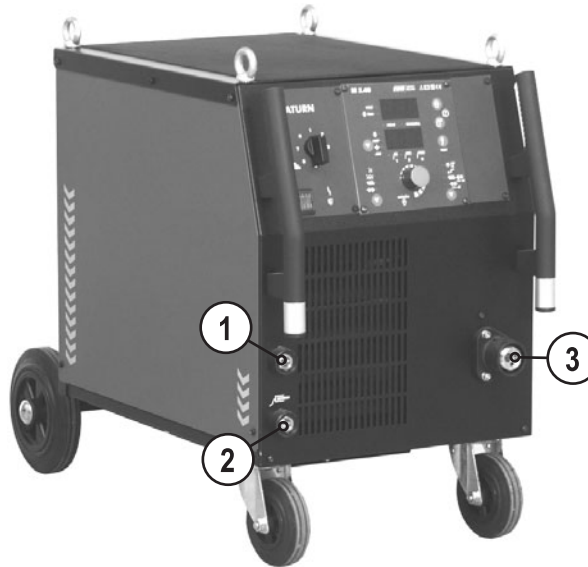

Figure 5-2

Item	Symbol	Description
1		Connection socket, workpiece lead "Hard" choke tapping
2		Connection socket, workpiece lead "Medium" choke tapping
3		Central connection for welding torch (Euro) Integrated welding current, shielding gas and torch trigger

- Insert central plug of the welding torch into the central connector and screw together with crown nut.
- Insert cable plug on the workpiece lead into the connection socket for workpiece lead 1 or 2 (depending on the application or shielding gas used) and lock by turning to the right.

5.7 Shielding gas supply

5.7.1 Connecting the shielding gas supply

WARNING



**Risk of injury due to improper handling of shielding gas cylinders!
Improper handling and insufficient securing of shielding gas cylinders
can cause serious injuries!**

- Secure shielding gas cylinders using the standard fastening elements on the unit (chain/belt)!
- The fastening elements must tightly enclose the shielding gas cylinder!
- Attach the fastening elements within the upper half of the shielding gas cylinder!
- Do not attach any element to the shielding gas cylinder valve!
- Observe the instructions from the gas manufacturer and any relevant regulations concerning the use of compressed air!
- Avoid heating the shielding gas cylinder!

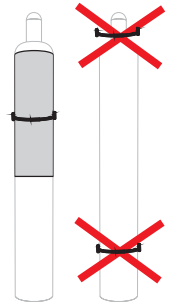

CAUTION



Faults in the shielding gas supply.

An unhindered shielding gas supply from the shielding gas cylinder to the welding torch is a fundamental requirement for optimum welding results. In addition, a blocked shielding gas supply may result in the welding torch being destroyed.

- Always re-fit the yellow protective cap when not using the shielding gas connection.
- All shielding gas connections must be gas tight.

NOTE



Before connecting the pressure regulator to the gas cylinder, open the cylinder valve briefly to expel any dirt.

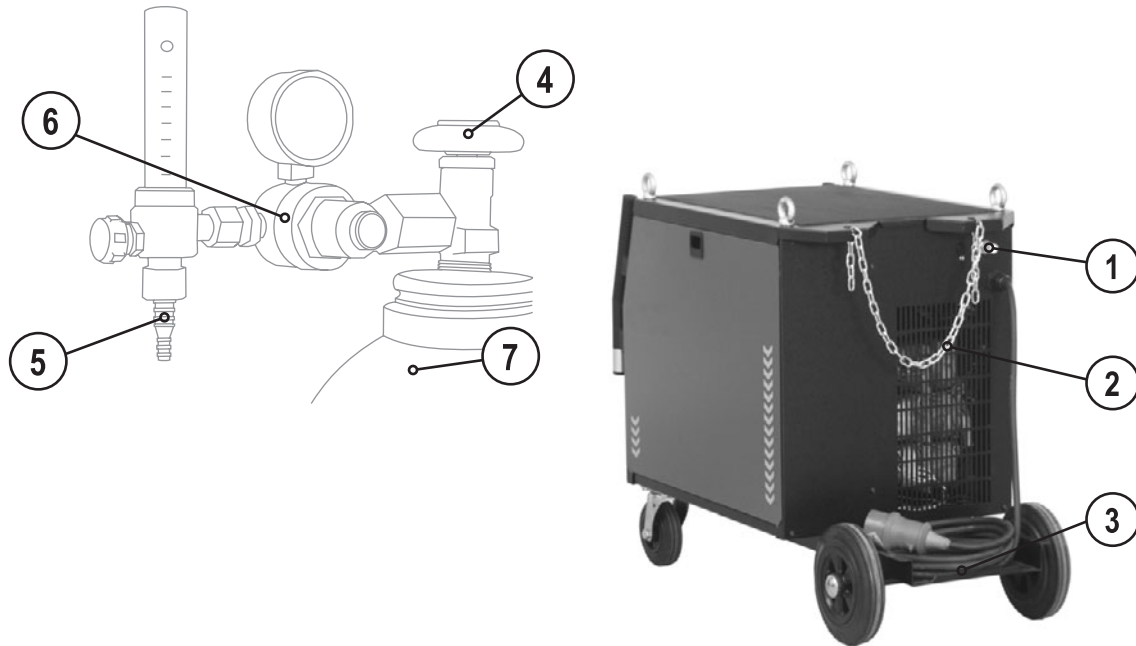

Figure 5-3

Item	Symbol	Description
1		G1/4" connecting nipple Shielding gas connection on the pressure regulator.
2		Securing elements for shielding gas cylinder (strap/chain)
3		Bracket for shielding gas cylinder
4		Cylinder valve
5		Output side of the pressure regulator
6		Pressure regulator
7		Shielding gas cylinder

- Place the shielding gas cylinder into the relevant cylinder bracket.
- Secure the shielding gas cylinder using a securing chain.
- Tighten the pressure regulator screw connection on the gas bottle valve to be gas-tight.
- Tighten gas hose on pressure regulator to be gas tight.

5.7.2 Setting the shielding gas quantity

Welding process	Recommended shielding gas quantity
MAG welding	Wire diameter x 11.5 = l/min
MIG brazing	Wire diameter x 11.5 = l/min
MIG welding (aluminium)	Wire diameter x 13.5 = l/min (100 % argon)
TIG	Gas nozzle diameter in mm corresponds to l/min gas throughput

Helium-rich gas mixtures require a higher gas volume!

The table below can be used to correct the gas volume calculated where necessary:

Shielding gas	Factor
75% Ar/25% He	1.14
50% Ar/50% He	1.35
25% Ar/75% He	1.75
100% He	3.16

NOTE



Incorrect shielding gas setting!

If the shielding gas setting is too low or too high, this can introduce air to the weld pool and may cause pores to form.

- Adjust the shielding gas quantity to suit the welding task!

5.8 Inserting the wire electrode

5.8.1 Inserting the wire spool

NOTE



Standard D300 wire spool holder can be used. Adapters (see accessories) are required when using standardised basket coils (DIN 8559).

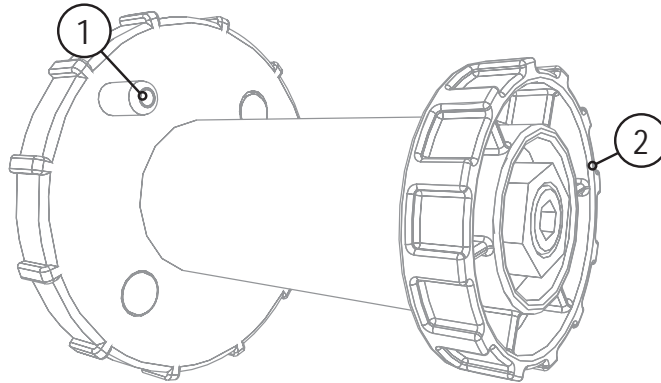

Figure 5-4

Item	Symbol	Description
1		Carrier pin For fixing the wire spool
2		Knurled nut For fixing the wire spool

- Loosen knurled nut from spool holder.
- Fix welding wire reel onto the spool holder so that the carrier pin locks into the spool bore.
- Fasten wire spool using knurled nut.



CAUTION



Risk of injury due to incorrectly secured wire spool.

If the wire spool is not secured properly, it may come loose from the wire spool holder and fall to the ground, causing damage to the machine and injuries.

- Securely fasten the wire spool to the wire spool holder using the knurled nut.
- Before you start working, always check the wire spool is securely fastened.

5.8.2 Changing the wire feed rollers

NOTE



Unsatisfactory welding results due to faulty wire feeding!

Wire feed rollers must be suitable for the diameter of the wire and the material.

- Check the roller label to verify that the rollers are suitable for the wire diameter. Turn or change if necessary!
- use V-groove rollers with for steel wires and other hard wires,
- use U-groove rollers for aluminium wires and other soft, alloyed wires.

- Slide new drive rollers into place so that the diameter of the wire used is visible on the drive roller.
- Screw the drive rollers in place with knurled screws.

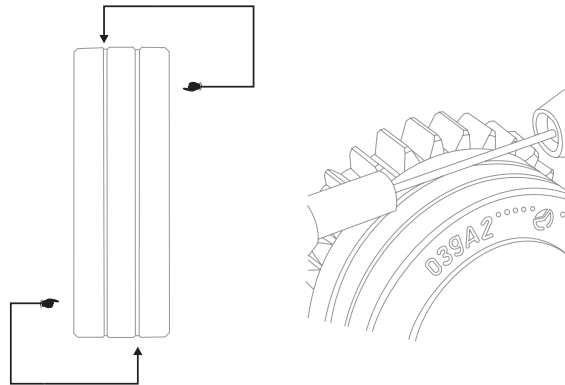

Figure 5-5

5.8.3 Inching the wire electrode

CAUTION



Risk of injury due to welding wire escaping in an unpredictable manner!
Welding wire can be conveyed at very high speeds and, if conveyed incorrectly, may escape in an uncontrolled manner and injure persons!

- Before mains connection, set up the complete wire guide system from the wire spool to the welding torch!
- Remove the pressure rollers from the wire feed unit if no welding torch is fitted!
- Check wire guide at regular intervals!
- Keep all casing covers closed during operation!

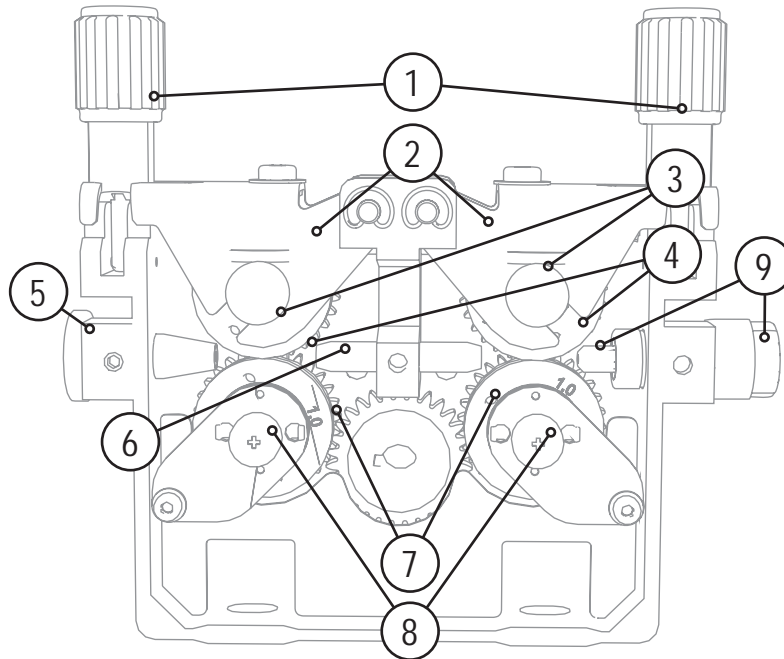

Figure 5-6

NOTE



Depending on the design of the machine, the design of the wire feed may be the reverse of that shown!

Item	Symbol	Description
1		Pressure units
2		Clamping units
3		Knurled nut
4		Pressure rollers
5		Wire holding nipple
6		Guide tube
7		Drive rollers
8		"Undetachable" knurled screws
9		Wire feed nipple with wire stabiliser

- Extend and lay out the torch tube package.
- Unfasten pressure units and fold out (clamping units and pressure rollers will automatically flip upwards).
- Unwind welding wire carefully from the wire spool and insert through the wire inlet nipple over the drive roller grooves and the guide pipe into the capillary tube and Teflon core using guide pipe.
- Press the clamping element with the pressure roller back downwards and fold the wire units back up again (wire electrode should be in the groove on the drive roller).
- Set the contact pressure with the adjusting nuts of the pressure unit.
- Press the wire inching button until the wire electrode projects out of the welding torch.

CAUTION



Extensive wear due to incorrect contact pressure!

Incorrect contact pressure will cause extensive wear of the wire feed rollers!

- With the adjusting nuts of the pressure units set the contact pressure so that the wire electrode is conveyed but will still slip through if the wire spool jams.
- Set the contact pressure of the front rollers (in wire feed direction) to a higher value!

5.8.4 Spool brake setting

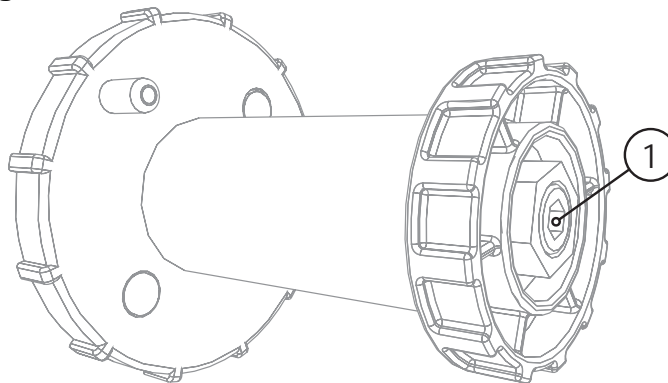

Figure 5-7

Item	Symbol	Description
1		Allen screw Securing the wire spool retainer and adjustment of the spool brake

- Tighten the Allen screw (8 mm) in the clockwise direction to increase the braking effect.

NOTE



Tighten the spool brake until the wire spool no longer turns when the wire feed motor stops but without it jamming during operation!











5.9 MIG/MAG functional sequences / operating modes

NOTE



There are optimum pre-sets for welding parameters such as gas pre-flow and burn back, etc. for numerous applications (although these can also be changed if required).

5.9.1 Explanation of signs and functions

Symbol	Meaning
	Press torch trigger
	Release torch trigger
	Tap torch trigger (press briefly and release)
	Shielding gas flowing
I	Welding output
	Wire electrode is being conveyed
	Wire creep
	Wire burn-back
	Gas pre-flows
	Gas post-flows
	Non-latched
	Latched
t	Time
t1	Spot time
t2	Interval pause
tZn	Ignition time

5.9.2 Non-latched operation

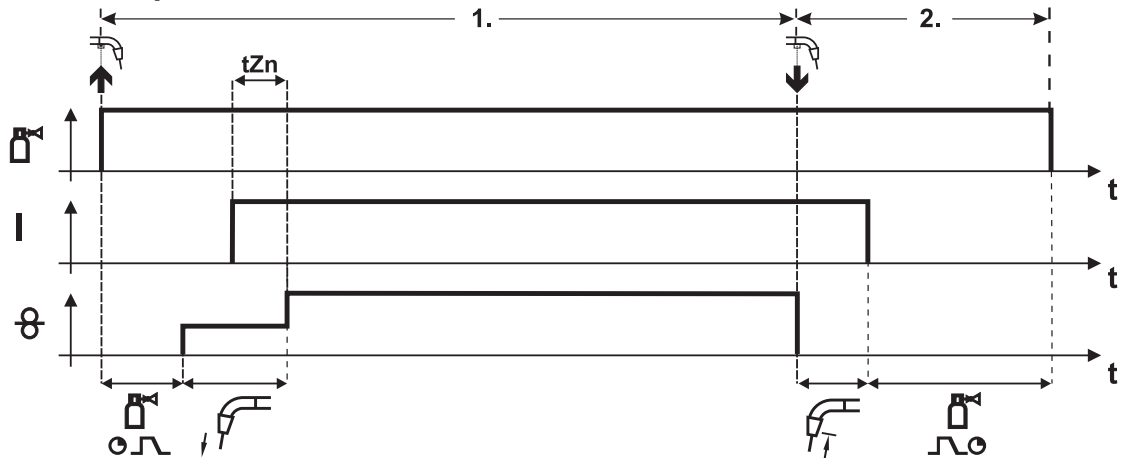

Figure 5-8

Step 1

- Press and hold torch trigger.
- Shielding gas is expelled (gas pre-flows).
- Wire feed motor runs at "creep speed".
- Arc ignites after the wire electrode makes contact with the workpiece; welding current flows.
- Changeover to the pre-selected wire speed after the set ignition time (t_{Zn}).

Step 2

- Release torch trigger.
- WF motor stops.
- Arc is extinguished after the pre-selected wire burn-back time elapses.
- Gas post-flow time elapses.

5.9.3 Latched operation

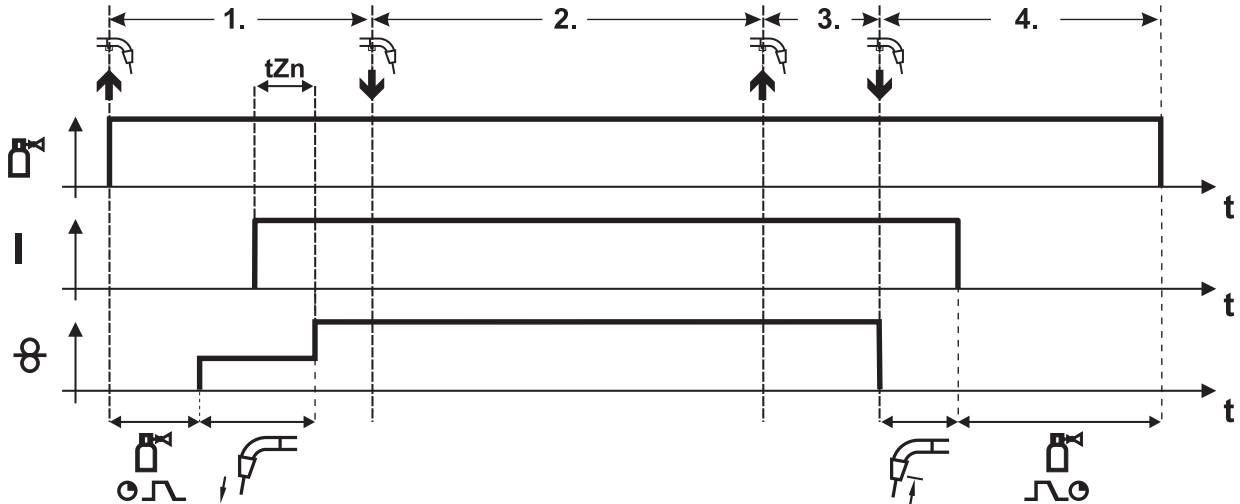

Figure 5-9

Step 1

- Press and hold torch trigger.
- Shielding gas is expelled (gas pre-flows).
- Wire feed motor runs at "creep speed".
- Arc ignites when the wire electrode makes contact with the workpiece; welding current flows.
- Changeover to the pre-selected wire speed after the set ignition time (t_{Zn}).

Step 2

- Release torch trigger (no effect).

Step 3

- Press torch trigger (no effect).

Step 4

- Release torch trigger.
- WF motor stops.
- Arc is extinguished after the pre-selected wire burn-back time elapses.
- Gas post-flow time elapses.

5.9.4 Spot welding

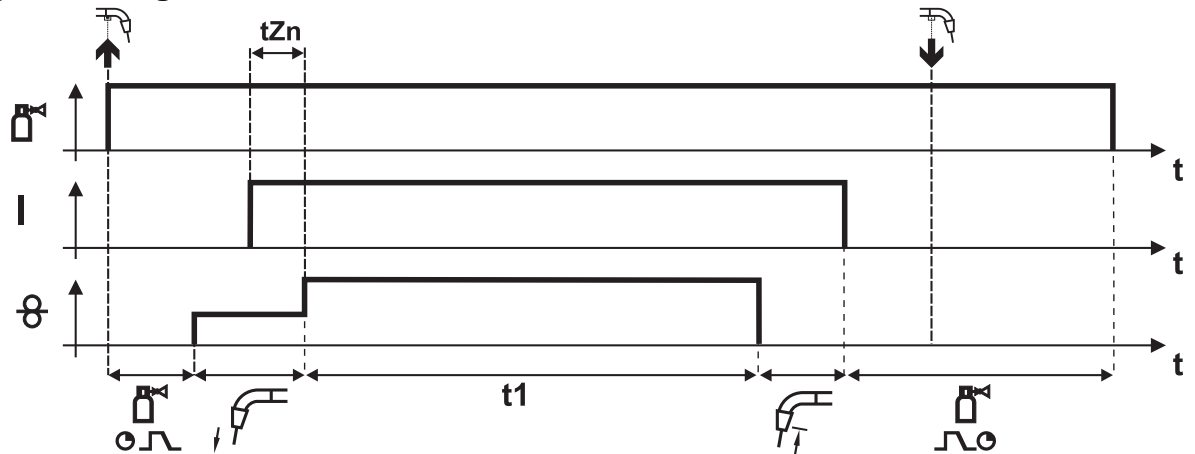

Figure 5-10

1. Start

- Press and hold torch trigger.
- Shielding gas is expelled (gas pre-flows).
- Wire feed motor runs at "creep speed".
- Arc ignites after the wire electrode makes contact with the workpiece; welding current flows.
- Changeover to the pre-selected wire speed after the set ignition time (t_{Zn}).
- The WF stops after the set spot welding time elapses.
- Arc is extinguished after the pre-selected wire burn-back time elapses.
- Gas post-flow time elapses.

2. End

- Release torch trigger.

NOTE

When the torch trigger is released, the welding process is also interrupted even before the spot time elapses.
With fast tacking (time between two welding process under approx. 1.5 seconds) the gas pre-flow, the creep process and also the ignition time (t_{Zn}) are not required.

5.9.5 Interval

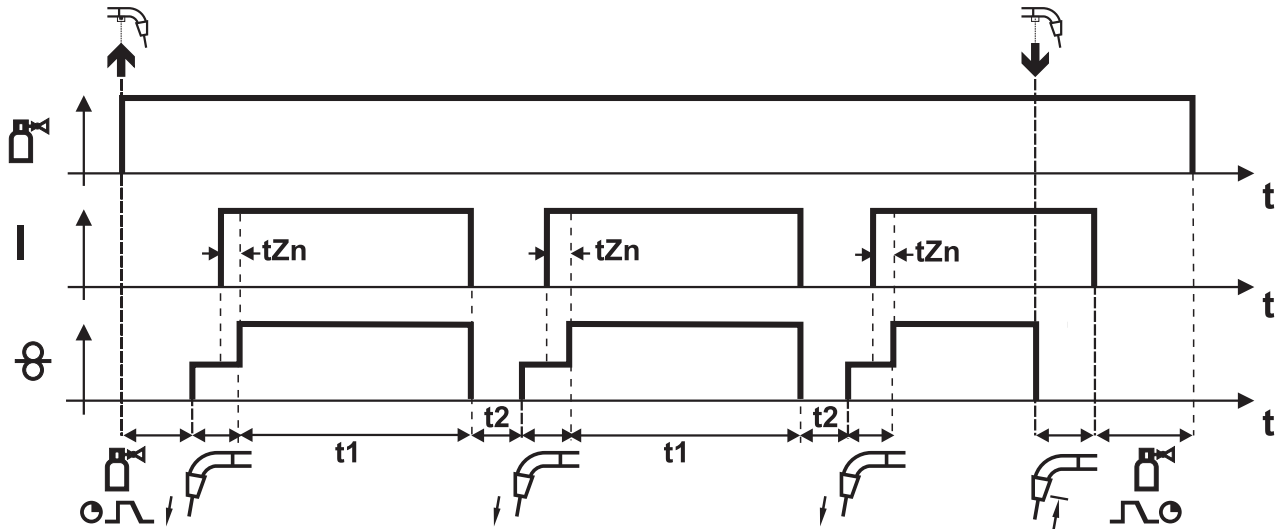

Figure 5-11

1. Start

- Press and hold torch trigger.
- Shielding gas is expelled (gas pre-flows).
- Wire-feed motor runs at "creep-start speed".
- Arc ignites after the wire electrode makes contact with the workpiece; welding current flows.
- Changeover to the pre-selected wire speed after the set ignition time (t_{Zn}).
- The wire feed stops after the pulse time expires.
- Arc is extinguished after the wire burn-back time elapses.
- The process is repeated after the pause time elapses.

2. End

- Release torch trigger.
- Wire feed stops.
- Arc is extinguished after the wire burn-back time elapses.
- Gas post-flow time elapses.

NOTE



When the torch trigger is released, the welding process is also interrupted even before the spot time elapses.

With fast tacking (time between two welding process under approx. 1.5 seconds) the gas pre-flow, the creep process and also the ignition time (t_{Zn}) are not required.

5.9.6 MIG/MAG automatic cut-out

NOTE



The welding machine ends the ignition process or the welding process with an

- Ignition fault (no welding current flows within 5 s after the start signal).
- Arc interruption (arc is interrupted for longer than 2 s).

6 Maintenance, care and disposal



DANGER



Risk of injury from electric shock!

Cleaning machines that are not disconnected from the mains can lead to serious injuries!

- Disconnect the machine completely from the mains.
- Remove the mains plug!
- Wait for 4 minutes until the capacitors have discharged!

6.1 General

When used in the specified environmental conditions and under normal operating conditions, this machine is largely maintenance-free and requires a minimum of care.

There are some points, which should be observed, to guarantee fault-free operation of your welding machine. Among these are regular cleaning and checking as described below, depending on the pollution level of the environment and the length of time the unit is in use.

6.2 Maintenance work, intervals

6.2.1 Daily maintenance tasks

- Check correct mounting of the wire spool.
- Mains supply lead and its strain relief
- Welding current cables (check that they are fitted correctly and secured)
- Gas tubes and their switching equipment (solenoid valve)
- Gas cylinder securing elements
- Operating, message, safety and adjustment devices (Functional test)
- Other, general condition

6.2.2 Monthly maintenance tasks

- Casing damage (front, rear and side walls)
- Wheels and their securing elements
- Transport elements (strap, lifting lugs, handle)
- Selector switches, command devices, emergency stop devices, voltage reducing devices, message and control lamps
- Check coolant tubes and their connections for impurities
- Check that the wire guide elements (inlet nipple, wire guide tube) are fitted securely.

6.2.3 Annual test (inspection and testing during operation)

NOTE



The welding machine may only be tested by competent, capable persons!

A capable person is one who, because of his training, knowledge and experience, is able to recognise the dangers that can occur while testing welding power sources as well as possible subsequent damage and who is able to implement the required safety procedures.



For further information, please see the accompanying supplementary sheets "Machine and Company Data, Maintenance and Testing, Warranty"!

A periodic test according to IEC 60974-4 "Periodic inspection and test" has to be carried out. In addition to the regulations on testing given here, the relevant local laws and regulations must also be observed.

6.3 Maintenance work

 **DANGER**

 **Do not carry out any unauthorised repairs or modifications!**
To avoid injury and equipment damage, the unit must only be repaired or modified by specialist, skilled persons!
The warranty becomes null and void in the event of unauthorised interference.

- Appoint only skilled persons for repair work (trained service personnel)!

Repair and maintenance work may only be performed by qualified authorised personnel; otherwise the right to claim under warranty is void. In all service matters, always consult the dealer who supplied the machine. Return deliveries of defective equipment subject to warranty may only be made through your dealer. When replacing parts, use only original spare parts. When ordering spare parts, please quote the machine type, serial number and item number of the machine, as well as the type designation and item number of the spare part.

6.4 Disposing of equipment

NOTE

 **Proper disposal!**
The machine contains valuable raw materials, which should be recycled, and electronic components, which must be disposed of.

- Do not dispose of in household waste!
- Observe the local regulations regarding disposal!



6.4.1 Manufacturer's declaration to the end user

- According to European provisions (guideline 2002/96/EG of the European Parliament and the Council of January, 27th 2003), used electric and electronic equipment may no longer be placed in unsorted municipal waste. It must be collected separately. The symbol depicting a waste container on wheels indicates that the equipment must be collected separately.
This machine is to be placed for disposal or recycling in the waste separation systems provided for this purpose.
- According to German law (law governing the distribution, taking back and environmentally correct disposal of electric and electronic equipment (ElektroG) from 16.03.2005), used machines are to be placed in a collection system separate from unsorted municipal waste. The public waste management utilities (communities) have created collection points at which used equipment from private households can be disposed of free of charge.
- Information about giving back used equipment or about collections can be obtained from the respective municipal administration office.
- EWM participates in an approved waste disposal and recycling system and is registered in the Used Electrical Equipment Register (EAR) under number WEEE DE 57686922.
- In addition to this, returns are also possible throughout Europe via EWM sales partners.

6.5 Meeting the requirements of RoHS

We, EWM HIGHTEC Welding GmbH Mündersbach, hereby confirm that all products supplied by us which are affected by the RoHS Directive, meet the requirements of the RoHS (Directive 2002/95/EC).

7 Rectifying faults

All products are subject to rigorous production checks and final checks. If, despite this, something fails to work at any time, please check the product using the following flowchart. If none of the fault rectification procedures described leads to the correct functioning of the product, please inform your authorised dealer.

7.1 Customer checklist

Legend

↘: Fault/Cause

✘: Remedy

NOTE



The correct machine equipment for the material and process gas in use is a fundamental requirement for perfect operation!

Wire feed problems

- ↘ Contact tip blocked
 - ✘ Clean, spray with anti-spatter spray and replace if necessary
- ↘ Setting the spool brake (see "Setting the spool brake" chapter)
 - ✘ Check settings and correct if necessary
- ↘ Setting pressure units (see "Inching wire electrodes" chapter)
 - ✘ Check settings and correct if necessary
- ↘ Worn wire rolls
 - ✘ Check and replace if necessary
- ↘ Wire feed motor without supply voltage (automatic cutout triggered by overloading)
 - ✘ Reset triggered fuse (rear of the power source) by pressing the key button
- ↘ Kinked hose packages
 - ✘ Extend and lay out the torch hose package
- ↘ Wire guide core or spiral is dirty or worn
 - ✘ Clean core or spiral; replace kinked or worn cores

Functional errors

- ↘ Machine control without displaying the signal lights after switching on
 - ✘ Phase failure > check mains connection (fuses)
- ↘ No welding performance
 - ✘ Phase failure > check mains connection (fuses)
- ↘ Various parameters cannot be set
 - ✘ Entry level is blocked, disable access lock (see chapter entitled "Lock welding parameters against unauthorised access")
- ↘ Connection problems
 - ✘ Make control lead connections and check that they are fitted correctly.
- ↘ Loose welding current connections
 - ✘ Tighten power connections on the torch and/or on the workpiece
 - ✘ Tighten contact tip/collet correctly

7.2 Check the machine type setting

NOTE

- Only with the M2.xx machine control.
- After switching on, the machine type that has been set is displayed for a short time, denoted as "tyP".
If the machine type displayed does not match the machine, you have to correct this setting.



„tyP 00“	Saturn 251
„tyP d00“	Saturn 256
„tyP 01“	Saturn 301
„tyP r01“	Mira 301 (M2.xx)
„tyP 02“	Saturn 351
„tyP d02“	Wega 351, Saturn 351 DG
„tyP d03“	Wega 401,451
„tyP d04“	Wega 501,601







7.2.1 Setting the machine type

Operating element	Action	Result
	1 x	Switch off the welding machine.
		Press and hold both buttons.
	1 x	Switch on the welding machine, "AnI" is shown on the display.
		Whilst "AnI" is being displayed, set the machine type: 0 Saturn 251 KGE 1 Saturn 301 KGE 2 Saturn 351 KGE 3 decompact (DK), all; Wega, all 7 Mira 301 KGE

7.3 Resetting the control (Reset all)

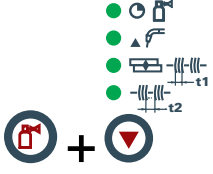
NOTE

-  **M2.xx control**
The first action should always be to check and if necessary correct the machine type setting.
-  **All user settings will be overwritten with factory settings and must therefore be checked afterwards, or set up again!**
After resetting the machine control to the factory settings, it is essential that the machine type used is checked and reset if necessary.

Operating element	Action	Result
	1 x 	Switch off the welding machine.
		Press and hold both buttons.
	1 x 	Switch on the welding machine, "rES" is shown briefly on the display.

8 Technical data

NOTE



Performance specifications and guarantee only in connection with original spare and replacement parts!

8.1 Saturn 301, 351 KG

Saturn	301 KG	351 KG
Switching steps	12	16
Setting range for welding current	30 A to 300 A	30 A to 350 A
Max. welding current at 40 °C ambient temperature		
40% DC	300 A	350 A
60% DC	190 A	250 A
100% DC	160 A	220 A
Max. welding current at 25 °C ambient temperature		
45% DC	300 A	350 A
60% DC	250 A	300 A
100% DC	190 A	250 A
Open circuit voltage	15.5 V to 38.2 V	15.5 V to 37.5 V
Mains connection lead	H07RN-F4G2.5	
Mains voltage (tolerances)	3 x 400 V (-15% to +15%)	
Frequency	50/60 Hz	
Mains fuse (safety fuse, slow-blow)	3 x 25 A	
Max. connected load	12.8 kVA	16 kVA
Recommended generator power	18 kVA	21.5 kVA
cosφ	0.95	
Insulation class/protection classification	H/IP 23	
Ambient temperature	-20 °C to +40 °C	
Machine/torch cooling	Temperature-controlled fan/gas	
Wire feed speed	0.5 m/min to 24 m/min	
Standard wire feed rollers	0.8 mm and 1.0 mm (for steel wire)	
Drive	4-roll drive (37 mm)	
Torch connection	Central connection for welding torch (Euro)	
Workpiece lead	50 mm ²	
Dimensions L x W x H (in mm)	930 x 460 x 730	
Weight	98.0 kg (M 1.02) 100.0 kg (M 2.x0)	115.0 kg (M 1.02) 114.0 kg (M 2.x0)
EMC class	A	
Constructed to standard	IEC 60974-1, -5, -10 ☑ / CE	

9 Accessories

NOTE



Performance-dependent accessories like torches, workpiece leads, electrode holders or intermediate hose packages are available from your authorised dealer.

9.1 Options

Type	Designation	Item no.
ON FILTER S	Retrofit option, dirt filter for air inlet	092-002090-00000
ON FSB WHEELS S	Retrofit option for locking brake for machine wheels	092-002109-00000
ON HOSE/FR MOUNT	Optional holder for tubes and remote control for machines without star handle	092-002116-00000
ON WIRE CREEP POTI M1.02	Retrofit option, wire creep rotary dial	092-001102-00000

9.2 General accessories

Type	Designation	Item no.
AK300	Adapter for K300 basket coil	094-001803-00001
DM1 32L/MIN	Manometer pressure regulator	094-000009-00000
GH 2X1/4" 2M	Gas hose	094-000010-00001
GS16L G1/4" SW 17	Pilot static tube	094-000914-00000
GS25L G1/4" SW 17	Pilot static tube	094-001100-00000
5POLE/CEE/32A/M	Machine plug	094-000207-00000

10 Replaceable parts

10.1 Wire feed rollers

CAUTION



Damage due to the use of non-genuine parts!

The manufacturer's warranty becomes void if non-genuine parts are used!

- Only use system components and options (power sources, welding torches, electrode holders, remote controls, spare parts and replacement parts, etc.) from our range of products!
- Only insert and lock accessory components into the relevant connection socket when the machine is switched off.

10.1.1 Wire feed rollers for steel wire

Type	Designation	Item no.
FE 2DR4R 0,6+0,8	Drive rollers, 37 mm, steel	092-000839-00000
FE 2DR4R 0,8+1,0	Drive rollers, 37 mm, steel	092-000840-00000
FE 2DR4R 0,9+1,2	Drive rollers, 37 mm, steel	092-000841-00000
FE 2DR4R 1,0+1,2	Drive rollers, 37 mm, steel	092-000842-00000
FE 2DR4R 1,2+1,6	Drive rollers, 37 mm, steel	092-000843-00000
FE/AL 2GR4R	Pressure rollers, smooth, 37mm	092-000844-00000

10.1.2 Wire feed rollers for aluminium wire

Type	Designation	Item no.
AL 4ZR4R 0,8+1,0	Twin rollers, 37 mm, for aluminium	092-000869-00000
AL 4ZR4R 1,0+1,2	Twin rollers, 37 mm, for aluminium	092-000848-00000
AL 4ZR4R 1,2+1,6	Twin rollers, 37 mm, for aluminium	092-000849-00000
AL 4ZR4R 2,4+3,2	Twin rollers, 37 mm, for aluminium	092-000870-00000

10.1.3 Wire feed rollers for cored wire

Type	Designation	Item no.
ROE 2DR4R 0,8/0,9+0,8/0,9	Drive rollers, 37 mm, cored wire	092-000834-00000
ROE 2DR4R 1,0/1,2+1,4/1,6	Drive rollers, 37 mm, cored wire	092-000835-00000
ROE 2DR4R 1,4/1,6+2,0/2,4	Drive rollers, 37 mm, cored wire	092-000836-00000
ROE 2DR4R 2,8+3,2	Drive rollers, 37 mm, cored wire	092-000837-00000
ROE 2GR4R	Pressure rollers, knurled, 37mm	092-000838-00000

10.1.4 Conversion sets

Type	Designation	Item no.
URUE VERZ>UNVERZ FE/AL 4R	Conversion kit, 37mm, 4-roller drive on non-toothed rollers (steel/aluminium)	092-000845-00000
URUE AL 4ZR4R 0,8+1,0	Conversion kit, 37mm, 4-roller drive for aluminium	092-000867-00000
URUE AL 4ZR4R 1,0+1,2	Conversion kit, 37mm, 4-roller drive for aluminium	092-000846-00000
URUE AL 4ZR4R 1,2+1,6	Conversion kit, 37mm, 4-roller drive for aluminium	092-000847-00000
URUE AL 4ZR4R 2,4+3,2	Conversion kit, 37mm, 4-roller drive for aluminium	092-000868-00000
URUE ROE 2DR4R 0,8/0,9+0,8/0,9	Conversion kit, 37mm, 4-roller drive for cored wire	092-000830-00000
URUE ROE 2DR4R 1,0/1,2+1,4/1,6	Conversion kit, 37mm, 4-roller drive for cored wire	092-000831-00000
URUE ROE 2DR4R 1,4/1,6+2,0/2,4	Conversion kit, 37mm, 4-roller drive for cored wire	092-000832-00000
URUE ROE 2DR4R 2,8+3,2	Conversion kit, 37mm, 4-roller drive for cored wire	092-000833-00000

Verschleißteile 4 Rollen-Antrieb Ø = 37mm		St= Stahl Al= Aluminium CrNi= Edelstahl Cu= Kupfer	St= Steel Al= Aluminium CrNi= Stainless steel Cu= Copper	Wear parts 4-Roller drive system Ø = 37mm	
V-Nut: St-, CrNi-, Cu-Draht „Standard V-Nut“, oben unverzahnt und glatt, Rollenbezeichnung: „1,0“			V-groove: St-, CrNi-, Cu wire „Standard V-groove“, on the top ungeared and plane, rolls description: „1,0“		
Antriebsrollen- Ø (b): <i>Drive rolls- Ø (b):</i> 0,6 + 0,8 0,8 + 1,0 0,9 + 1,2 1,0 + 1,2 1,2 + 1,6		Ersatzset: <i>Spare set:</i> 092-000839-00000 092-000840-00000 092-000841-00000 092-000842-00000 092-000843-00000			
Gegendruckrollenset (a) <i>Set of counter pressure rolls (a)</i> 092-000844-00000 Umrüstung verzahnt → unverzahnt: <i>conversion geared → ungeared:</i> 092-000845-00000					
U-Nut: Al-, Cu-Draht „Option U-Nut“, oben verzahnt, Rollenbezeichnung: „1,0 A2“			U-groove: Al-, Cu wire „Option U-groove“, on the top geared-twin rolls, rolls description: „1,0 A2“		
Antriebsrollen- Ø (a+b): <i>Drive rolls- Ø (a+b):</i> 0,8 + 1,0 1,0 + 1,2 1,2 + 1,6 2,4 + 3,2		Ersatzset: <i>Spare set:</i> 092-000869-00000 092-000848-00000 092-000849-00000 092-000870-00000		Umrüstset: <i>Conversion set:</i> 092-000867-00000 092-000846-00000 092-000847-00000 092-000868-00000	
U-Nut gerändelt: Füll-/Röhrchendraht „Option U-Nut gerändelt“, oben verzahnt, ohne Nut gerändelt, Rollenbezeichnung: „1,0-1,2 R“			knurled U-groove: Cored wire „Option knurled U-groove“, on the top geared, without knurled groove, rolls description: „1,0-1,2 R“		
Antriebsrollen- Ø (b): <i>Drive rolls- Ø (b):</i> 0,8 / 0,9 + 0,8 / 0,9 1,0 / 1,2 + 1,4 / 1,6 1,4 / 1,6 + 2,0 / 2,4 2,8 + 3,2		Ersatzset: <i>Spare set:</i> 092-000834-00000 092-000835-00000 092-000836-00000 092-000837-00000		Umrüstset: <i>Conversion set:</i> 092-000830-00000 092-000831-00000 092-000832-00000 092-000833-00000	
Gegendruckrollenset (a): <i>Set of counterpressure rolls (a):</i> 092-000838-00000					

Figure 10-1

11 Appendix A
11.1 Setting instructions
11.1.1 Saturn 301

SATURN 301		EWM HIGHTEC WELDING															
mm	mm	SG2/3 G3/4 Si1 Ar 82/18				SG2/3 G3/4 Si1 CO ₂ 100				CrNi Ar 98/2				AlMg Ar 100			
		m/min			$\frac{1}{m}$ $\frac{2}{m}$ $\frac{3}{m}$	m/min			$\frac{1}{m}$ $\frac{2}{m}$ $\frac{3}{m}$	m/min			$\frac{1}{m}$ $\frac{2}{m}$ $\frac{3}{m}$	m/min			$\frac{1}{m}$ $\frac{2}{m}$ $\frac{3}{m}$
0,8	0,8	1,1	0	1	1	2,5	0	1	1	2,8	0	2	1	7,6	0	2	2
	1,0	1,4	0	2	1	1,0	0	1	1	2,3	0	2	1	7,1	0	2	2
1,0	0,8	1,1	0	1	1	2,5	0	1	1	2,8	0	2	1	7,6	0	2	2
	1,0	1,4	0	2	1	1,2	0	2	1	2,3	0	2	1	7,1	0	2	2
	1,2	1,6	0	2	1	0,5	0	2	1	1,5	0	2	1	5,3	0	2	2
1,5	0,8	3,8	0	5	1	3,5	0	5	1	3,4	0	3	1	8,5	0	3	2
	1,0	1,6	0	3	1	1,8	0	5	1	2,7	0	3	1	7,9	0	3	2
	1,2	1,9	0	3	1	1,5	0	5	1	2,1	0	3	1	6,0	0	3	2
2,0	0,8	6,1	0	7	2	4,3	0	7	1	6,3	0	5	1	10,8	0	5	2
	1,0	2,9	0	5	1	3,4	0	7	1	4,0	0	5	1	9,8	0	5	2
	1,2	3,0	0	5	2	2,1	0	6	1	3,7	0	5	1	6,6	0	4	2
	1,6	1,5	0	3	1	1,3	0	6	1	1,4	0	3	1	6,1	0	4	2
3,0	0,8	10,5	0	9	2	6,0	0	9	1	10,1	0	7	2	13,8	0	7	2
	1,0	4,8	0	7	2	4,8	0	8	1	6,8	0	7	2	12,3	0	7	2
	1,2	4,3	0	7	2	2,8	0	7	1	6,0	0	7	2	8,2	0	6	2
	1,6	2,2	0	5	2	1,6	0	7	1	2,5	0	7	1	7,0	0	5	2
4,0	0,8	12,0	0	10	2	10,3	0	11	2	13,7	0	9	2	15,5	0	8	2
	1,0	7,3	0	9	2	6,8	0	9	1	9,4	0	9	2	14,0	0	8	2
	1,2	5,0	0	8	2	4,2	0	9	2	7,9	0	9	2	9,2	0	7	2
	1,6	2,8	0	7	2	1,9	0	8	1	3,4	0	9	2	8,0	0	6	2
5,0	0,8	16,6	0	12	2	11,9	0	12	2	15,3	0	10	2	17,7	0	9	2
	1,0	8,8	0	10	2	8,7	0	10	1	11,1	0	10	2	16,1	0	9	2
	1,2	6,0	0	9	2	5,1	0	10	2	8,4	0	10	2	10,4	0	8	2
	1,6	3,5	0	9	2	2,3	0	9	2	4,3	0	10	2	9,6	0	8	2
6,0	0,8	16,6	0	12	2	11,9	0	12	2	15,3	0	10	2	17,7	0	9	2
	1,0	10,5	0	11	2	11,1	0	11	2	12,8	0	11	2	16,1	0	9	2
	1,2	6,0	0	9	2	5,1	0	10	2	9,4	0	11	2	12,0	0	9	2
	1,6	3,9	0	10	2	3,0	0	10	2	5,3	0	11	2	9,6	0	8	2
8,0	0,8	16,6	0	12	2	11,9	0	12	2	22,7	0	12	2	22,4	0	11	2
	1,0	11,8	0	12	2	13,8	0	12	2	14,1	0	12	2	20,4	0	11	2
	1,2	9,0	0	11	2	7,2	0	12	2	11,6	0	12	2	14,0	0	10	2
	1,6	4,8	0	12	2	3,8	0	11	2	6,2	0	12	2	10,3	0	9	2
10,0	0,8	16,6	0	12	2	11,9	0	12	2	22,7	0	12	2	22,4	0	11	2
	1,0	11,8	0	12	2	13,8	0	12	2	14,1	0	12	2	20,4	0	11	2
	1,2	9,7	0	12	2	7,2	0	12	2	11,6	0	12	2	16,7	0	11	2
	1,6	4,8	0	12	2	4,4	0	12	2	6,2	0	12	2	10,8	0	10	2
12,0	1,0	11,8	0	12	2	13,8	0	12	2	14,1	0	12	2	21,3	0	12	2
	1,2	9,7	0	12	2	7,2	0	12	2	11,6	0	12	2	16,7	0	11	2
	1,6	4,8	0	12	2	4,4	0	12	2	6,2	0	12	2	11,7	0	11	2
	1,0	11,8	0	12	2	13,8	0	12	2	14,1	0	12	2	21,3	0	12	2
14,0	1,2	9,7	0	12	2	7,2	0	12	2	11,6	0	12	2	19,9	0	12	2
	1,6	4,8	0	12	2	4,4	0	12	2	6,2	0	12	2	12,9	0	12	2
	1,0	11,8	0	12	2	13,8	0	12	2	14,1	0	12	2	21,3	0	12	2
	1,2	9,7	0	12	2	7,2	0	12	2	11,6	0	12	2	19,9	0	12	2
16,0	1,6	4,8	0	12	2	4,4	0	12	2	6,2	0	12	2	12,9	0	12	2
	1,0	11,8	0	12	2	13,8	0	12	2	14,1	0	12	2	21,3	0	12	2
	1,2	9,7	0	12	2	7,2	0	12	2	11,6	0	12	2	19,9	0	12	2
20,0	1,2	9,7	0	12	2	7,2	0	12	2	11,6	0	12	2	19,9	0	12	2
	1,6	4,8	0	12	2	4,4	0	12	2	6,2	0	12	2	12,9	0	12	2

Figure 11-1

11.1.2 Saturn 351

SATURN 351		EWM HIGHTEC WELDING															
mm	mm	SG2/3 G3/4 Si1 Ar 82/18				SG2/3 G3/4 Si1 CO ₂ 100				CrNi Ar 98/2				AlMg Ar 100			
		m/min			$\frac{1}{m}$ $\frac{2}{mm}$ $\frac{3}{mm}$	m/min			$\frac{1}{m}$ $\frac{2}{mm}$ $\frac{3}{mm}$	m/min			$\frac{1}{m}$ $\frac{2}{mm}$ $\frac{3}{mm}$	m/min			$\frac{1}{m}$ $\frac{2}{mm}$ $\frac{3}{mm}$
0,8	0,8	1,6	0	1	1	1,3	0	1	1	1,7	0	1	1	7,2	0	1	2
	1,0	1,5	0	1	1	1,0	0	1	1	1,3	0	1	1	6,7	0	1	2
1,0	0,8	2,2	0	2	1	1,3	0	1	1	2,7	0	2	1	8,1	0	2	2
	1,0	2,0	0	2	1	1,0	0	1	1	1,8	0	2	1	7,5	0	2	2
	1,2	1,7	0	2	1	0,4	0	1	1	1,3	0	1	1	5,6	0	2	2
1,5	0,8	2,6	0	3	1	2,7	0	6	1	5,5	0	5	1	8,7	0	3	2
	1,0	2,0	0	2	1	2,1	0	6	1	2,2	0	3	1	8,1	0	3	2
	1,2	1,7	0	2	1	1,3	0	5	1	1,8	0	2	1	6,1	0	3	2
2,0	0,8	3,6	0	5	2	3,7	0	7	1	7,8	0	7	1	10,6	0	5	2
	1,0	2,5	0	3	1	3,0	0	7	1	3,9	0	5	1	9,7	0	5	2
	1,2	1,9	0	3	1	1,8	0	6	1	2,1	0	3	1	6,6	0	4	2
	1,6	1,4	0	3	1	1,7	0	8	1	1,7	0	3	1	6,1	0	4	2
3,0	0,8	5,2	0	7	2	6,2	0	9	1	11,3	0	9	1	12,8	0	7	2
	1,0	2,6	0	4	1	3,9	0	8	1	6,2	0	7	1	11,4	0	7	2
	1,2	2,7	0	5	1	3,2	0	8	1	3,5	0	6	1	7,9	0	6	2
4,0	1,6	1,7	0	5	1	2,0	0	9	1	2,4	0	5	1	7,5	0	6	2
	0,8	8,0	0	9	2	7,9	0	10	1	14,2	0	11	2	15,5	0	9	2
	1,0	2,9	0	5	1	4,6	0	9	1	8,7	0	9	1	14,0	0	9	2
5,0	1,2	3,9	0	7	2	4,7	0	10	2	4,8	0	8	1	9,4	0	8	2
	1,6	1,9	0	6	1	2,3	0	10	1	3,1	0	7	1	8,4	0	7	2
	0,8	12,3	0	12	2	9,4	0	11	2	15,5	0	12	2	17,4	0	10	2
6,0	1,0	4,4	0	7	2	5,6	0	10	1	10,9	0	11	2	15,7	0	10	2
	1,2	4,9	0	8	2	5,4	0	11	2	5,4	0	9	1	10,4	0	9	2
	1,6	2,4	0	7	1	3,2	0	12	2	3,8	0	9	1	9,1	0	8	2
	0,8	23,2	0	16	2	10,6	0	12	2	20,5	0	13	2	19,2	0	11	2
8,0	1,0	6,2	0	9	2	7,7	0	12	2	11,9	0	12	2	17,4	0	11	2
	1,2	5,8	0	9	2	6,3	0	12	2	6,8	0	11	2	11,7	0	10	2
	1,6	4,0	0	9	1	3,2	0	12	2	4,8	0	11	2	9,6	0	9	2
10,0	0,8	23,2	0	16	2	12,8	0	13	2	23,6	0	16	2	21,3	0	12	2
	1,0	7,1	0	10	2	8,9	0	13	2	18,6	0	14	2	19,2	0	12	2
	1,2	8,0	0	12	2	8,9	0	14	2	7,4	0	12	2	13,2	0	11	2
	1,6	4,9	0	12	2	5,0	0	14	2	5,2	0	12	2	10,6	0	11	2
12,0	0,8	23,2	0	16	2	18,6	0	16	2	23,6	0	16	2	22,6	0	13	2
	1,0	7,9	0	11	2	13,1	0	16	2	22,6	0	16	2	20,6	0	13	2
	1,2	9,3	0	13	2	10,3	0	16	2	12,3	0	14	2	14,8	0	12	2
	1,6	5,1	0	13	2	5,4	0	15	2	6,8	0	13	2	11,0	0	12	2
14,0	1,0	10,8	0	13	2	13,1	0	16	2	22,6	0	16	2	21,4	0	14	2
	1,2	10,9	0	14	2	10,3	0	16	2	15,9	0	16	2	17,4	0	13	2
	1,6	5,4	0	14	2	5,9	0	16	2	9,0	0	14	2	11,9	0	13	2
16,0	1,0	14,9	0	15	2	13,1	0	16	2	22,6	0	16	2	21,8	0	15	2
	1,2	12,4	0	16	2	10,3	0	16	2	15,9	0	16	2	20,1	0	14	2
	1,6	5,6	0	16	2	5,9	0	16	2	10,0	0	15	2	12,9	0	14	2
20,0	1,0	16,4	0	16	2	13,1	0	16	2	22,6	0	16	2	22,3	0	16	2
	1,2	12,4	0	16	2	10,3	0	16	2	15,9	0	16	2	13,5	0	15	2
	1,6	5,6	0	16	2	5,9	0	16	2	10,8	0	16	2	13,5	0	15	2

Figure 11-2

12 Appendix B

12.1 Overview of EWM branches

Headquarters

EWM HIGHTEC WELDING GmbH
Dr. Günter-Henle-Straße 8
56271 Mündersbach · Germany
Tel: +49 2680 181-0 · Fax: -244
www.ewm-group.com · info@ewm-group.com

Technology centre

EWM HIGHTEC WELDING GmbH
Forststr. 7-13
56271 Mündersbach · Germany
Tel: +49 2680 181-0 · Fax: -144
www.ewm-group.com · info@ewm-group.com

Production, Sales and Service

EWM HIGHTEC WELDING GmbH
Dr. Günter-Henle-Straße 8
56271 Mündersbach · Germany
Tel: +49 2680 181-0 · Fax: -244
www.ewm-group.com · info@ewm-group.com

EWM HIGHTEC WELDING (Kunshan) Ltd.
10 Yuanshan Road, Kunshan · New & High-tech Industry Development Zone
Kunshan · Jiangsu · 215300 · People's Republic of China
Tel: +86 512 57867-188 · Fax: -182
www.ewm-group.com/cn · info.cn@ewm-group.com

EWM HIGHTEC WELDING AUTOMATION GmbH
Boxbachweg 4
08606 Oelsnitz/V. · Germany
Tel: +49 37421 20-300 · Fax: -318
www.ewm-group.com/automation · automation@ewm-group.com

EWM HIGHTEC WELDING s.r.o.
Tr. 9. května 718 / 31
407 53 Jiřikov · Czech Republic
Tel: +420 412 358-551 · Fax: -504
www.ewm-group.com/cz · info.cz@ewm-group.com

Sales and Service Germany

EWM HIGHTEC WELDING GmbH
Lindenstraße 1a
38723 Seesen-Rhüden · Tel: +49 5384 90798-0 · Fax: -20
www.ewm-group.com/handel · nl-seesen@ewm-group.com

EWM Schweißtechnik-Handels-GmbH
Sachsstraße 28
50259 Pulheim · Tel: +49 2234 697-047 · Fax: -048
www.ewm-group.com/handel · nl-koeln@ewm-group.com

EWM HIGHTEC WELDING GmbH
In der Florinskaul 14-16
56218 Mülheim-Kärlich · Tel: +49 261 988898-0 · Fax: -20
www.ewm-group.com/handel · nl-muelheim@ewm-group.com

EWM Schweißtechnik-Handels-GmbH
Eiserfelder Straße 300
57080 Siegen · Tel: +49 271 3878103-0 · Fax: -9
www.ewm-group.com/handel · nl-siegen@ewm-group.com

EWM HIGHTEC WELDING GmbH
Vertriebs- und Technologiezentrum
Draisstraße 2a
69469 Weinheim · Tel: +49 6201 84557-0 · Fax: -20
www.ewm-group.com/handel · nl-weinheim@ewm-group.com

EWM Schweißtechnik Handels GmbH
Rittergasse 1
89143 Blaubeuren · Tel: +49 7344 9191-75 · Fax: -77
www.ewm-group.com/handel · nl-ulm@ewm-group.com

EWM Schweißtechnik Handels GmbH
Heinkelstraße 8
89231 Neu-Ulm · Tel: +49 731 7047939-0 · Fax: -15
www.ewm-group.com/handel · nl-ulm@ewm-group.com

EWM HIGHTEC WELDING AUTOMATION GmbH
Steinfeldstrasse 15
90425 Nürnberg · Tel: +49 911 3841-727 · Fax: -728
www.ewm-group.com/automation
automation-nl-nuernberg@ewm-group.com

Sales and Service International

EWM HIGHTEC WELDING GmbH
Fichtenweg 1
4810 Gmunden · Austria · Tel: +43 7612 778 02-0 · Fax: -20
www.ewm-group.com/at · info.at@ewm-group.com

EWM HIGHTEC WELDING UK Ltd.
Unit 2B Coopies Way · Coopies Lane Industrial Estate
Morpeth · Northumberland · NE61 6JN · Great Britain
Tel: +44 1670 505875 · Fax: -514305
www.ewm-group.com/uk · info.uk@ewm-group.com

EWM HIGHTEC WELDING (Kunshan) Ltd.
10 Yuanshan Road, Kunshan · New & High-tech Industry Development Zone
Kunshan · Jiangsu · 215300 · People's Republic of China
Tel: +86 512 57867-188 · Fax: -182
www.ewm-group.com/cn · info.cn@ewm-group.com

EWM HIGHTEC WELDING Sales s.r.o. / Prodejní a poradenské centrum
Tyršova 2106
256 01 Benešov u Prahy · Czech Republic
Tel: +420 317 729-517 · Fax: -712
www.ewm-group.com/cz · sales.cz@ewm-group.com

EWM HIGHTEC WELDING FZCO / Regional Office Middle East
LOB 21 G 16 · P.O. Box 262851
Jebel Ali Free Zone · Dubai, UAE · United Arab Emirates
Tel: +971 48870-322 · Fax: -323
www.ewm-group.com/me · info.me@ewm-group.com