



EN

Welding machine

Picotig 200 puls TG

099-002058-EW501

Observe additional system documents!

26.11.2020

**Register now
and benefit!
Jetzt Registrieren
und Profitieren!**

www.ewm-group.com



General instructions

WARNING



Read the operating instructions!

The operating instructions provide an introduction to the safe use of the products.

- Read and observe the operating instructions for all system components, especially the safety instructions and warning notices!
- Observe the accident prevention regulations and any regional regulations!
- The operating instructions must be kept at the location where the machine is operated.
- Safety and warning labels on the machine indicate any possible risks. Keep these labels clean and legible at all times.
- The machine has been constructed to state-of-the-art standards in line with any applicable regulations and industrial standards. Only trained personnel may operate, service and repair the machine.
- Technical changes due to further development in machine technology may lead to a differing welding behaviour.

In the event of queries on installation, commissioning, operation or special conditions at the installation site, or on usage, please contact your sales partner or our customer service department on +49 2680 181-0.

A list of authorised sales partners can be found at www.ewm-group.com/en/specialist-dealers.

Liability relating to the operation of this equipment is restricted solely to the function of the equipment. No other form of liability, regardless of type, shall be accepted. This exclusion of liability shall be deemed accepted by the user on commissioning the equipment.

The manufacturer is unable to monitor whether or not these instructions or the conditions and methods are observed during installation, operation, usage and maintenance of the equipment.

An incorrectly performed installation can result in material damage and injure persons as a result. For this reason, we do not accept any responsibility or liability for losses, damages or costs arising from incorrect installation, improper operation or incorrect usage and maintenance or any actions connected to this in any way.

© EWM AG

Dr. Günter-Henle-Strasse 8
56271 Mündersbach Germany
Tel.: +49 2680 181-0, Fax: -244
Email: info@ewm-group.com
www.ewm-group.com

The copyright to this document remains the property of the manufacturer.

Copying, including extracts, only permitted with written approval.

The content of this document has been prepared and reviewed with all reasonable care. The information provided is subject to change; errors excepted.

1 Contents

1	Contents	3
2	For your safety	5
2.1	Notes on using these operating instructions.....	5
2.2	Explanation of icons.....	6
2.3	Safety instructions.....	7
2.4	Transport and installation	10
3	Intended use	12
3.1	Applications.....	12
3.2	Software version	12
3.3	Documents which also apply	12
3.3.1	Warranty	12
3.3.2	Declaration of Conformity.....	12
3.3.3	Welding in environments with increased electrical hazards.....	12
3.3.4	Service documents (spare parts and circuit diagrams).....	12
3.3.5	Calibration/Validation	12
3.3.6	Part of the complete documentation.....	13
4	Machine description – quick overview	14
4.1	Front view	14
4.2	Rear view	15
4.3	Machine control – Operating elements	16
4.3.1	Welding data display	17
5	Design and function	18
5.1	Transport and installation	18
5.1.1	Machine cooling.....	18
5.1.2	Workpiece lead, general.....	18
5.1.3	Ambient conditions	19
5.1.3.1	In operation	19
5.1.3.2	Transport and storage.....	19
5.1.4	Transport belt	19
5.1.4.1	Adjusting the length of the carrying strap	19
5.1.5	Notes on the installation of welding current leads	20
5.1.6	Stray welding currents	21
5.1.7	Mains connection.....	22
5.1.7.1	Mains configuration	22
5.2	TIG welding.....	23
5.2.1	Welding torch and workpiece line connection	23
5.2.1.1	Control lead connection	23
5.2.2	Shielding gas supply (shielding gas cylinder for welding machine)	24
5.2.2.1	Pressure regulator connection	24
5.2.2.2	Shielding gas hose connection	25
5.2.2.3	Gas test – setting the shielding gas volume	25
5.2.3	Arc ignition.....	26
5.2.3.1	HF ignition	26
5.2.3.2	Liftarc	26
5.2.3.3	Automatic cut-out	26
5.2.4	Welding task selection.....	27
5.2.5	Operating modes (functional sequences)	27
5.2.5.1	Legend	27
5.2.5.2	TIG non-latched operation	28
5.2.5.3	TIG latched operation.....	29
5.2.6	Welding torch (operating variants)	30
5.2.6.1	Tapping function (tap torch trigger).....	30
5.2.6.2	Torch mode setting	30
5.2.6.3	Up/down speed	30
5.2.6.4	Standard TIG torch (5-pole).....	30
5.2.7	Average value pulse welding.....	33
5.2.8	Expert menu (TIG).....	34
5.3	MMA welding	35

5.3.1	Connecting the electrode holder and workpiece lead	35
5.3.2	Welding task selection	35
5.3.3	Hotstart	36
5.3.4	Arcforce.....	36
5.3.5	Antistick.....	36
5.3.6	Average value pulse welding.....	36
5.3.7	Expert menu (MMA).....	37
5.4	Remote control.....	38
5.4.1	RTF1 19POL.....	38
5.4.2	RT1 19POL.....	38
5.5	Power-saving mode (Standby).....	38
5.6	Machine configuration menu	39
6	Maintenance, care and disposal	41
6.1	General.....	41
6.1.1	Cleaning.....	41
6.1.2	Dirt filter.....	41
6.2	Maintenance work, intervals	42
6.2.1	Daily maintenance tasks.....	42
6.2.2	Monthly maintenance tasks	42
6.2.3	Annual test (inspection and testing during operation)	42
6.3	Disposing of equipment.....	43
7	Rectifying faults.....	44
7.1	Checklist for rectifying faults	44
7.2	Error messages (power source).....	45
7.3	Resetting welding parameters to the factory settings	47
7.4	Display machine control software version.....	47
7.5	Dynamic power adjustment.....	47
8	Technical data.....	48
8.1	Picotig 200	48
9	Accessories	49
9.1	Transport system	49
9.2	Options.....	49
9.3	Remote controls and accessories.....	49
9.4	General accessories	49
10	Appendix	50
10.1	Parameter overview – setting ranges	50
10.1.1	TIG welding.....	50
10.1.2	MMA welding	50
10.1.3	Basic parameters (independent of process).....	51
10.2	Searching for a dealer.....	52

2 For your safety

2.1 Notes on using these operating instructions

DANGER

Working or operating procedures which must be closely observed to prevent imminent serious and even fatal injuries.

- Safety notes include the "DANGER" keyword in the heading with a general warning symbol.
- The hazard is also highlighted using a symbol on the edge of the page.

WARNING

Working or operating procedures which must be closely observed to prevent serious and even fatal injuries.

- Safety notes include the "WARNING" keyword in the heading with a general warning symbol.
- The hazard is also highlighted using a symbol in the page margin.

CAUTION

Working or operating procedures which must be closely observed to prevent possible minor personal injury.

- The safety information includes the "CAUTION" keyword in its heading with a general warning symbol.
- The risk is explained using a symbol on the edge of the page.



Technical aspects which the user must observe to avoid material or equipment damage.

Instructions and lists detailing step-by-step actions for given situations can be recognised via bullet points, e.g.:

- Insert the welding current lead socket into the relevant socket and lock.

2.2 Explanation of icons

Symbol	Description	Symbol	Description
	Indicates technical aspects which the user must observe.		Activate and release / Tap / Tip
	Switch off machine		Release
	Switch on machine		Press and hold
			Switch
	Incorrect / Invalid		Turn
	Correct / Valid		Numerical value – adjustable
	Input		Signal light lights up in green
	Navigation		Signal light flashes green
	Output		Signal light lights up in red
	Time representation (e.g.: wait 4 s / actuate)		Signal light flashes red
	Interruption in the menu display (other setting options possible)		
	Tool not required/do not use		
	Tool required/use		

2.3 Safety instructions

WARNING



Risk of accidents due to non-compliance with the safety instructions!
Non-compliance with the safety instructions can be fatal!

- Carefully read the safety instructions in this manual!
- Observe the accident prevention regulations and any regional regulations!
- Inform persons in the working area that they must comply with the regulations!



Risk of injury from electrical voltage!

Voltages can cause potentially fatal electric shocks and burns on contact. Even low voltages can cause a shock and lead to accidents.

- Never touch live components such as welding current sockets or stick, tungsten or wire electrodes!
- Always place torches and electrode holders on an insulated surface!
- Wear the full personal protective equipment (depending on the application)!
- The machine may only be opened by qualified personnel!
- The device must not be used to defrost pipes!



Hazard when interconnecting multiple power sources!

If a number of power sources are to be connected in parallel or in series, only a technical specialist may interconnect the sources as per standard IEC 60974-9:2010: Installation and use and German Accident Prevention Regulation BVG D1 (formerly VBG 15) or country-specific regulations.

Before commencing arc welding, a test must verify that the equipment cannot exceed the maximum permitted open circuit voltage.

- Only qualified personnel may connect the machine.
- When taking individual power sources out of operation, all mains and welding current leads must be safely disconnected from the welding system as a whole. (Hazard due to reverse polarity voltage!)
- Do not interconnect welding machines with pole reversing switch (PWS series) or machines for AC welding since a minor error in operation can cause the welding voltages to be combined, which is not permitted.



Risk of injury due to improper clothing!

During arc welding, radiation, heat and voltage are sources of risk that cannot be avoided. The user has to be equipped with the complete personal protective equipment at all times. The protective equipment has to include:

- Respiratory protection against hazardous substances and mixtures (fumes and vapours); otherwise implement suitable measures such as extraction facilities.
- Welding helmet with proper protection against ionizing radiation (IR and UV radiation) and heat.
- Dry welding clothing (shoes, gloves and body protection) to protect against warm environments with conditions comparable to ambient temperatures of 100 °C or higher and arcing and work on live components.
- Hearing protection against harming noise.

WARNING



Risk of injury due to radiation or heat!

Arc radiation can lead to skin and eye injuries.

Contact with hot workpieces and sparks can lead to burns.

- Use hand shield or welding helmet with the appropriate safety level (depends on the application).
- Wear dry protective clothing (e.g. hand shield, gloves, etc.) in accordance with the applicable regulations of your country.
- Persons who are not directly involved should be protected with a welding curtain or suitable safety screen against radiation and the risk of blinding!



Explosion risk!

Apparently harmless substances in closed containers may generate excessive pressure when heated.

- Move containers with inflammable or explosive liquids away from the working area!
- Never heat explosive liquids, dusts or gases by welding or cutting!



Fire hazard!

Due to the high temperatures, sparks, glowing parts and hot slag that occur during welding, there is a risk of flames.

- Be watchful of potential sources of fire in the working area!
- Do not carry any easily inflammable objects, e.g. matches or lighters.
- Ensure suitable fire extinguishers are available in the working area!
- Thoroughly remove any residue of flammable materials from the workpiece prior to starting to weld.
- Only further process workpieces after they have cooled down. Do not allow them to contact any flammable materials!

⚠ CAUTION**Smoke and gases!**

Smoke and gases can lead to breathing difficulties and poisoning. In addition, solvent vapour (chlorinated hydrocarbon) may be converted into poisonous phosgene due to the ultraviolet radiation of the arc!

- Ensure that there is sufficient fresh air!
- Keep solvent vapour away from the arc beam field!
- Wear suitable breathing apparatus if appropriate!

**Noise exposure!**

Noise exceeding 70 dBA can cause permanent hearing damage!

- Wear suitable ear protection!
- Persons located within the working area must wear suitable ear protection!



According to IEC 60974-10, welding machines are divided into two classes of electromagnetic compatibility (the EMC class can be found in the Technical data) > see 8 chapter:



Class A machines are not intended for use in residential areas where the power supply comes from the low-voltage public mains network. When ensuring the electromagnetic compatibility of class A machines, difficulties can arise in these areas due to interference not only in the supply lines but also in the form of radiated interference.



Class B machines fulfil the EMC requirements in industrial as well as residential areas, including residential areas connected to the low-voltage public mains network.

Setting up and operating

When operating arc welding systems, in some cases, electro-magnetic interference can occur although all of the welding machines comply with the emission limits specified in the standard. The user is responsible for any interference caused by welding.

In order to **evaluate** any possible problems with electromagnetic compatibility in the surrounding area, the user must consider the following: (see also EN 60974-10 Appendix A)

- Mains, control, signal and telecommunication lines
- Radios and televisions
- Computers and other control systems
- Safety equipment
- The health of neighbouring persons, especially if they have a pacemaker or wear a hearing aid
- Calibration and measuring equipment
- The immunity to interference of other equipment in the surrounding area
- The time of day at which the welding work must be carried out

Recommendations for reducing interference emission

- Mains connection, e.g. additional mains filter or shielding with a metal tube
- Maintenance of the arc welding system
- Welding leads should be as short as possible and run closely together along the ground
- Potential equalization
- Earthing of the workpiece. In cases where it is not possible to earth the workpiece directly, it should be connected by means of suitable capacitors.
- Shielding from other equipment in the surrounding area or the entire welding system

**Electromagnetic fields!**

The power source may cause electrical or electromagnetic fields to be produced which could affect the correct functioning of electronic equipment such as IT or CNC devices, telecommunication lines, power cables, signal lines and pacemakers.



- Observe the maintenance instructions > see 6.2 chapter!
- Unwind welding leads completely!
- Shield devices or equipment sensitive to radiation accordingly!
- The correct functioning of pacemakers may be affected (obtain advice from a doctor if necessary).

CAUTION



Obligations of the operator!

The respective national directives and laws must be complied with when operating the machine!

- Implementation of national legislation relating to framework directive 89/391/EEC on the introduction of measures to encourage improvements in the safety and health of workers at work and associated individual guidelines.
- In particular, directive 89/655/EEC concerning the minimum safety and health requirements for the use of work equipment by workers at work.
- The regulations applicable to occupational safety and accident prevention in the country concerned.
- Setting up and operating the machine as per IEC 60974.-9.
- Brief the user on safety-conscious work practices on a regular basis.
- Regularly inspect the machine as per IEC 60974.-4.



The manufacturer's warranty becomes void if non-genuine parts are used!

- ***Only use system components and options (power sources, welding torches, electrode holders, remote controls, spare parts and replacement parts, etc.) from our range of products!***
- ***Only insert and lock accessory components into the relevant connection socket when the machine is switched off.***

Requirements for connection to the public mains network

High-performance machines can influence the mains quality by taking current from the mains network. For some types of machines, connection restrictions or requirements relating to the maximum possible line impedance or the necessary minimum supply capacity at the interface with the public network (Point of Common Coupling, PCC) can therefore apply. In this respect, attention is also drawn to the machines' technical data. In this case, it is the responsibility of the operator, where necessary in consultation with the mains network operator, to ensure that the machine can be connected.

2.4 Transport and installation

WARNING



Risk of injury due to improper handling of shielding gas cylinders!

Improper handling and insufficient securing of shielding gas cylinders can cause serious injuries!

- Observe the instructions from the gas manufacturer and any relevant regulations concerning the use of compressed air!
- Do not attach any element to the shielding gas cylinder valve!
- Prevent the shielding gas cylinder from heating up.

⚠ CAUTION**Risk of accidents due to supply lines!**

During transport, attached supply lines (mains leads, control cables, etc.) can cause risks, e.g. by causing connected machines to tip over and injure persons!

- Disconnect all supply lines before transport!

**Risk of tipping!**

There is a risk of the machine tipping over and injuring persons or being damaged itself during movement and set up. Tilt resistance is guaranteed up to an angle of 10° (according to IEC 60974-1).

- Set up and transport the machine on level, solid ground.
- Secure add-on parts using suitable equipment.

**Risk of accidents due to incorrectly installed leads!**

Incorrectly installed leads (mains, control and welding leads or intermediate hose packages) can present a tripping hazard.

- Lay the supply lines flat on the floor (avoid loops).
- Avoid laying the leads on passage ways.

**Risk of injury from heated coolant and its connections!**

The coolant used and its connection or connection points can heat up significantly during operation (water-cooled version). When opening the coolant circuit, escaping coolant may cause scalding.

- Open the coolant circuit only when the power source or cooling unit is switched off!
- Wear proper protective equipment (protective gloves)!
- Seal open connections of the hose leads with suitable plugs.



The units are designed for operation in an upright position!

Operation in non-permissible positions can cause equipment damage.

- ***Only transport and operate in an upright position!***



Accessory components and the power source itself can be damaged by incorrect connection!

- ***Only insert and lock accessory components into the relevant connection socket when the machine is switched off.***
- ***Comprehensive descriptions can be found in the operating instructions for the relevant accessory components.***
- ***Accessory components are detected automatically after the power source is switched on.***



Protective dust caps protect the connection sockets and therefore the machine against dirt and damage.

- ***The protective dust cap must be fitted if there is no accessory component being operated on that connection.***
- ***The cap must be replaced if faulty or if lost!***

3 Intended use

WARNING



Hazards due to improper usage!

The machine has been constructed to the state of the art and any regulations and standards applicable for use in industry and trade. It may only be used for the welding procedures indicated at the rating plate. Hazards may arise for persons, animals and material objects if the equipment is not used correctly. No liability is accepted for any damages arising from improper usage!

- The equipment must only be used in line with its designated purpose and by trained or expert personnel!
- Do not improperly modify or convert the equipment!

3.1 Applications

Arc welding machines for TIG DC welding with lift arc (touch starting) or HF ignition (contactless) and MMA welding as secondary process. It may be possible to expand the functionality by using accessories (see the documentation in the relevant chapter).

3.2 Software version

These instructions apply to the following software version:

0.5.9.0

The software version of the machine control can be displayed in the machine configuration menu (menu Srv) > see 5.6 chapter.

3.3 Documents which also apply

3.3.1 Warranty

For more information refer to the "Warranty registration" brochure supplied and our information regarding warranty, maintenance and testing at www.ewm-group.com!

3.3.2 Declaration of Conformity



This product corresponds in its design and construction to the EU directives listed in the declaration. The product comes with a relevant declaration of conformity in the original.

The manufacturer recommends carrying out the safety inspection according to national and international standards and guidelines every 12 months.

3.3.3 Welding in environments with increased electrical hazards



Power sources with this marking can be used for welding in an environment with increased electrical hazard (e.g. boilers). For this purpose, appropriate national or international regulations must be followed. The power source must not be placed in the danger zone!

3.3.4 Service documents (spare parts and circuit diagrams)

WARNING



Do not carry out any unauthorised repairs or modifications!

To avoid injury and equipment damage, the unit must only be repaired or modified by specialist, skilled persons!

The warranty becomes null and void in the event of unauthorised interference.

- Appoint only skilled persons for repair work (trained service personnel)!

Original copies of the circuit diagrams are enclosed with the unit.

Spare parts can be obtained from the relevant authorised dealer.

3.3.5 Calibration/Validation

An original certificate is enclosed with the product. The manufacturer recommends calibration / validation at intervals of 12 months.

3.3.6 Part of the complete documentation

This document is part of the complete documentation and valid only in combination with all other parts of these instructions! Read and observe the operating instructions for all system components, especially the safety instructions!

The illustration shows a general example of a welding system.

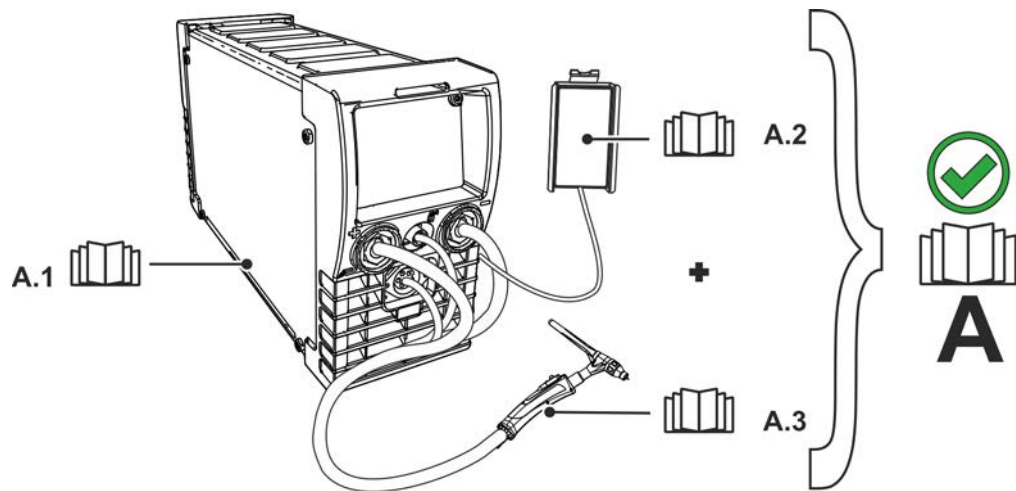

Figure 3-1

I-tem	Documentation
A.1	Power source
A.2	Remote control
A.3	Welding torch
A	Complete documentation

4 Machine description – quick overview

4.1 Front view

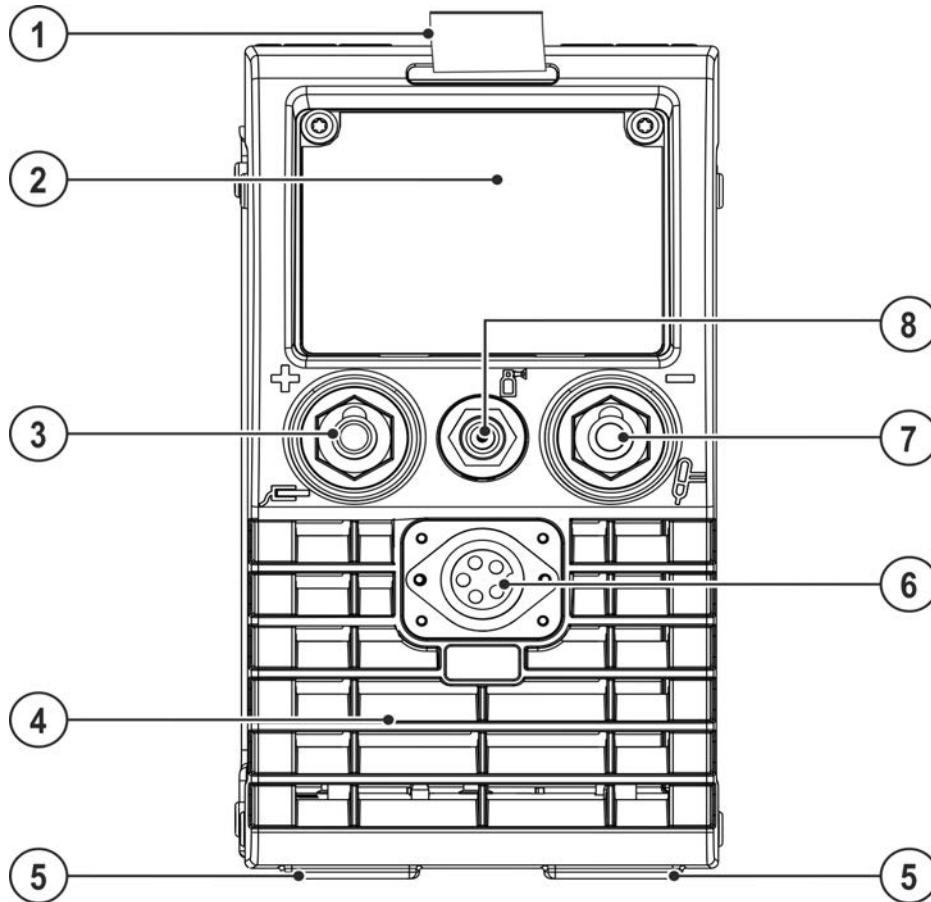

Figure 4-1

Item	Symbol	Description
1		Carrying strap > see 5.1.4.1 chapter
2		Machine control > see 4.3 chapter
3	+	Connection socket, “+” welding current How to connect the accessories depends on the welding procedure. Please observe the connection description for the corresponding welding procedure > see 5 chapter.
4		Cooling air outlet
5		Machine feet
6		Connection socket (welding torch control cable) > see 5.2.1.1 chapter
7	-	Connection socket, “-” welding current How to connect the accessories depends on the welding procedure. Please observe the connection description for the corresponding welding procedure > see 5 chapter.
8		Connection thread - G$\frac{1}{4}$” Shielding gas connection (outlet)

4.2 Rear view

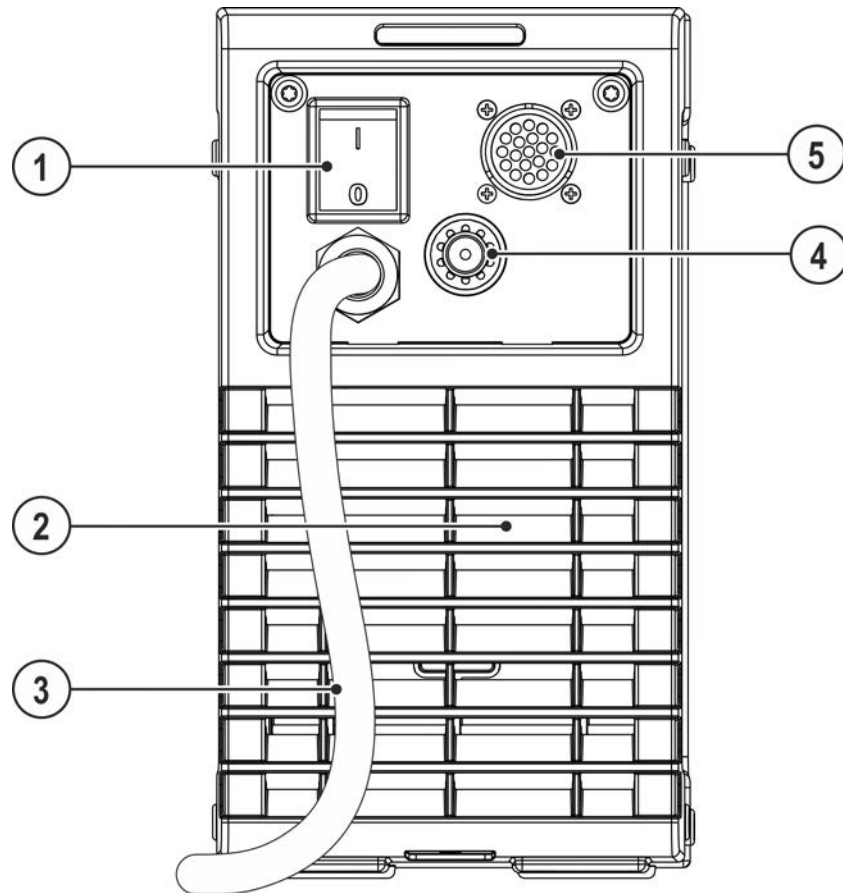

Figure 4-2

Item	Symbol	Description
1		Main Switch Switching the machine on or off.
2		Cooling air inlet
3		Mains connection cable > see 5.1.7 chapter
4		Connection thread - G$\frac{1}{4}$" Shielding gas connection (inlet)
5		Connection socket, 19-pole Remote control connection

4.3 Machine control – Operating elements

The parameters and their setting ranges are described in chapter Parameters Overview - Setting Ranges > see 10.1 chapter.

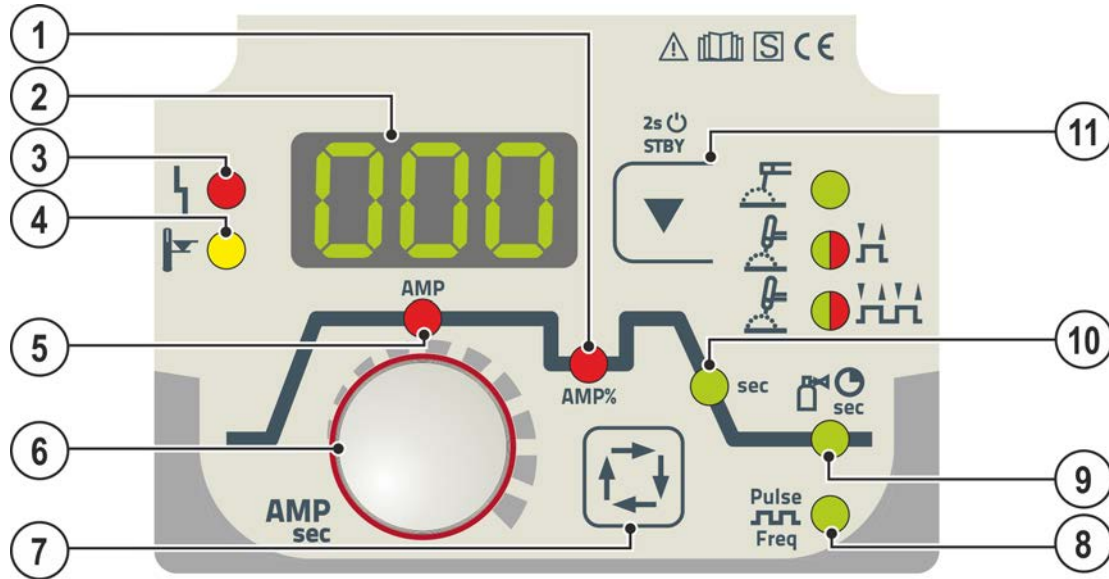

Figure 4-3

Item	Symbol	Description
1	AMP%	Secondary current I_2 (TIG)
2		Welding data display (3-digit) Displays the welding parameters and the corresponding values > see 4.3.1 chapter
3		Collective interference signal light For error messages, > see 7 chapter
4		Excess temperature signal light In case of excess temperature, temperature monitors de-activate the power unit, and the excess temperature control lamp comes on. Once the machine has cooled down, welding can continue without any further measures.
5	AMP	Main current signal light I _{min} to I _{max} (1 A increments)
6		Welding parameter setting rotary dial Setting currents, times and parameters.
7		Select welding parameters button This button is used to select the welding parameters depending on the welding process and operating mode used.
8		Pulse welding (average value pulses) signal light > see 5.2.7 chapter On:----- Function switched on \overline{ON} Not on:-- Function switched off \overline{OFF} Flashing: Parameter selection and frequency setting \overline{FrE} :
9		Signal light, gas post-flow time
10	sec	Down-slope time (TIG)
11		Welding procedure/power-saving mode push-button ● ---- MMA welding ● H -- TIG welding (non-latched operating mode) ● HH TIG welding (latched operating mode) Signal light green: HF start (contactless) switched on (ex works) Signal light red: Liftarc (contact ignition) switched on STBY---- Press for 2 s to put the machine into power-saving mode. To reactivate, activate one of the operating elements > see 5.5 chapter.

4.3.1 Welding data display

The machine will be calibrated for approx. 2 seconds each time it is switched on. This will be indicated by \overline{cRL} on the display. Subsequently, the value set for the dynamic power adjustment will be displayed for approx. 3 s > see 7.5 chapter.

The value shown on welding data display depends on the selected parameter (current or time). After approx. 5 s the display switches back to the welding current nominal value.

Advanced parameters are shown by the alternate display of the welding parameter with the respective value (the parameter code illuminates for approx. 2 s, parameter value illuminates for approx. 2 s). After approx. 60 s the display switches back to the welding current nominal value.

In case of failures, error codes are shown on the display > see 7.2 chapter.

5 Design and function

WARNING



Risk of injury from electrical voltage!

Contact with live parts, e.g. power connections, can be fatal!

- Observe the safety information on the first pages of the operating instructions!
- Commissioning must be carried out by persons who are specifically trained in handling power sources!
- Connect connection or power cables while the machine is switched off!

Read and observe the documentation to all system and accessory components!

5.1 Transport and installation

WARNING



Risk of accident due to improper transport of machines that must not be lifted!

Do not lift or suspend the machine! The machine can drop and cause injuries! The handles, straps or brackets are suitable for transport by hand only!

- The machine must not be suspended or lifted using a crane.

5.1.1 Machine cooling



Insufficient ventilation results in a reduction in performance and equipment damage.

- ***Observe the ambient conditions!***
- ***Keep the cooling air inlet and outlet clear!***
- ***Observe the minimum distance of 0.5 m from obstacles!***

5.1.2 Workpiece lead, general

CAUTION



Risk of burning due to incorrect welding current connection!

If the welding current plugs (machine connections) are not locked or if the workpiece connection is contaminated (paint, corrosion), these connections and leads can heat up and cause burns when touched!

- Check welding current connections on a daily basis and lock by turning to the right when necessary.
- Clean workpiece connection thoroughly and secure properly. Do not use structural parts of the workpiece as welding current return lead!

5.1.3 Ambient conditions



The machine must not be operated in the open air and must only be set up and operated on a suitable, stable and level base!

- *The operator must ensure that the ground is non-slip and level, and provide sufficient lighting for the place of work.*
- *Safe operation of the machine must be guaranteed at all times.*



Equipment damage due to contamination!

Unusually high amounts of dust, acids, corrosive gases or substances can damage the machine (observe maintenance intervals > see 6.2 chapter).

- *Avoid large amounts of smoke, steam, oily fumes, grinding dust and corrosive ambient air!*

5.1.3.1 In operation

Temperature range of the ambient air:

- -25 °C to +40 °C (-13 °F to 104 °F)

Relative humidity:

- up to 50 % at 40 °C (104 °F)
- up to 90 % at 20 °C (68 °F)

5.1.3.2 Transport and storage

Storage in a closed room, temperature range of the ambient air:

- -30 °C to +70 °C (-22 °F to 158 °F)

Relative humidity

- up to 90 % at 20 °C (68 °F)

5.1.4 Transport belt

5.1.4.1 Adjusting the length of the carrying strap

To demonstrate adjustment, lengthening the strap is shown in the figure. To shorten, the strap's loops must be inched in the opposite direction.

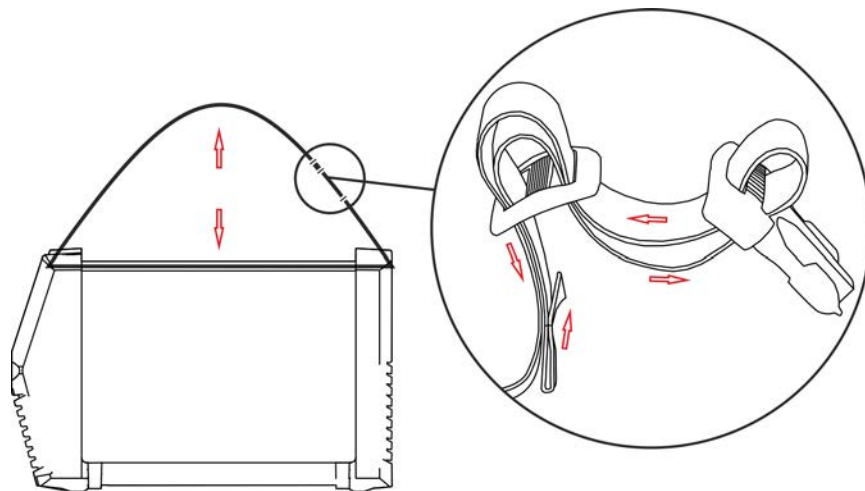

Figure 5-1

5.1.5 Notes on the installation of welding current leads

- Use an individual welding lead to the workpiece for each welding machine!

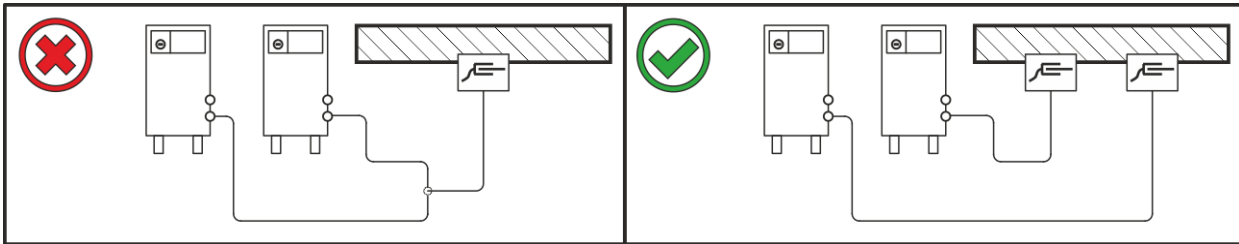

Figure 5-2

- Fully unroll welding current leads, torch hose packages and intermediate hose packages. Avoid loops!
- Always keep leads as short as possible!

Lay any excess cable lengths in meanders.

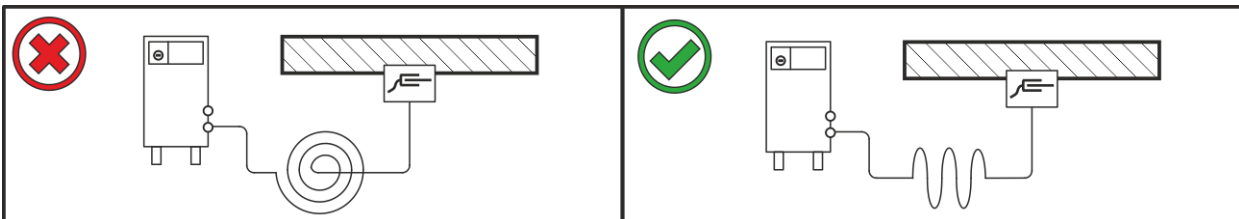

Figure 5-3

5.1.6 Stray welding currents

⚠ WARNING



Risk of injury due to stray welding currents!

Stray welding currents can destroy protective earth conductors, damage machines and electronic devices and cause overheating of components, leading to fire.

- Check that all welding current connections are firmly secured and electrical connections are in perfect condition.
- Set up, attach or suspend all conductive power source components such as casing, transport vehicles and crane frames so they are insulated.
- Do not place any other electronic devices such as drills or angle grinders on the power source, transport vehicle or crane frames unless they are insulated.
- Always put welding torches and electrode holders on an insulated surface when they are not in use.

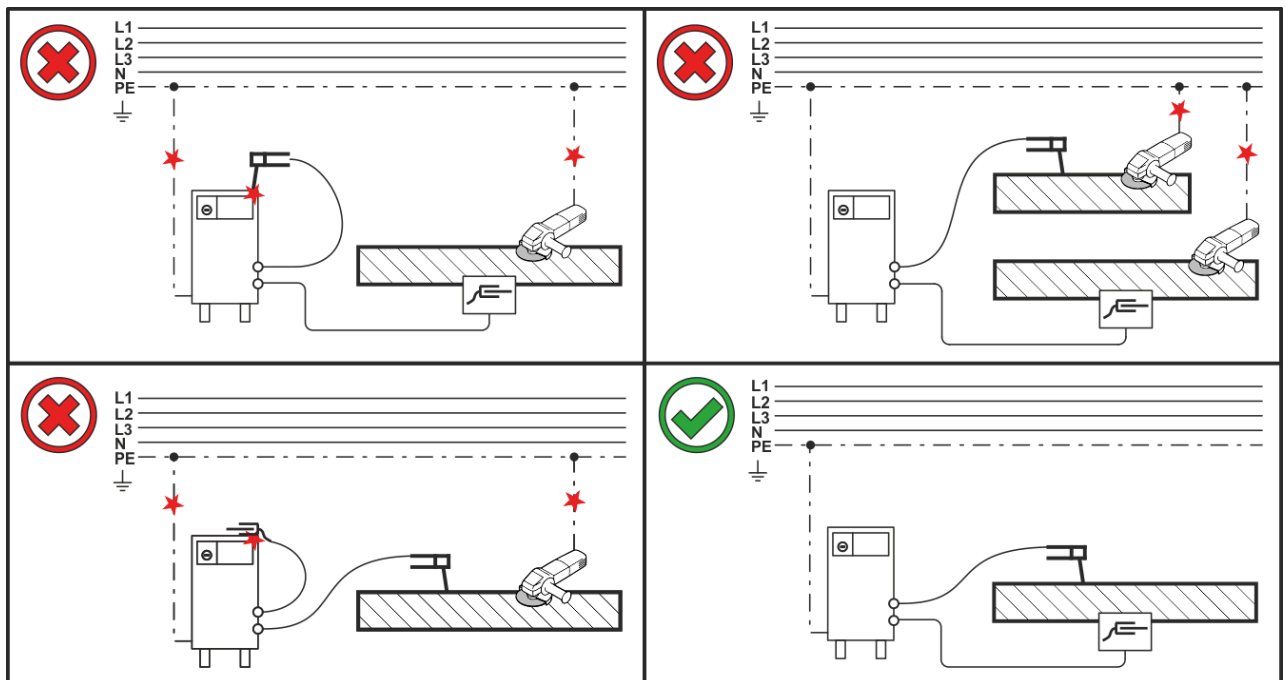

Figure 5-4

5.1.7 Mains connection

DANGER



Hazards caused by improper mains connection!

An improper mains connection can cause injuries or damage property!

- The connection (mains plug or cable), the repair or voltage adjustment of the device must be carried out by a qualified electrician in accordance with the respective local laws or national regulations!
- The mains voltage indicated on the rating plate must match the supply voltage.
- Only operate machine using a socket that has correctly fitted protective earth.
- Mains plug, socket and lead must be checked by a qualified electrician on a regular basis!
- When operating the generator, always ensure it is earthed as stipulated in the operating instructions. The network created must be suitable for operating machines according to protection class I.

5.1.7.1 Mains configuration



The machine may only be connected to a one-phase system with two conductors and an earthed neutral conductor.

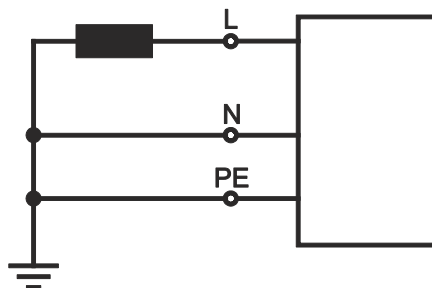

Figure 5-5

Legend

Item	Designation	Colour code
L	Outer conductor	brown
N	Neutral conductor	blue
PE	Protective conductor	green-yellow

- Insert mains plug of the switched-off machine into the appropriate socket.

5.2 TIG welding

5.2.1 Welding torch and workpiece line connection

Prepare welding torch according to the welding task in hand (see operating instructions for the torch).

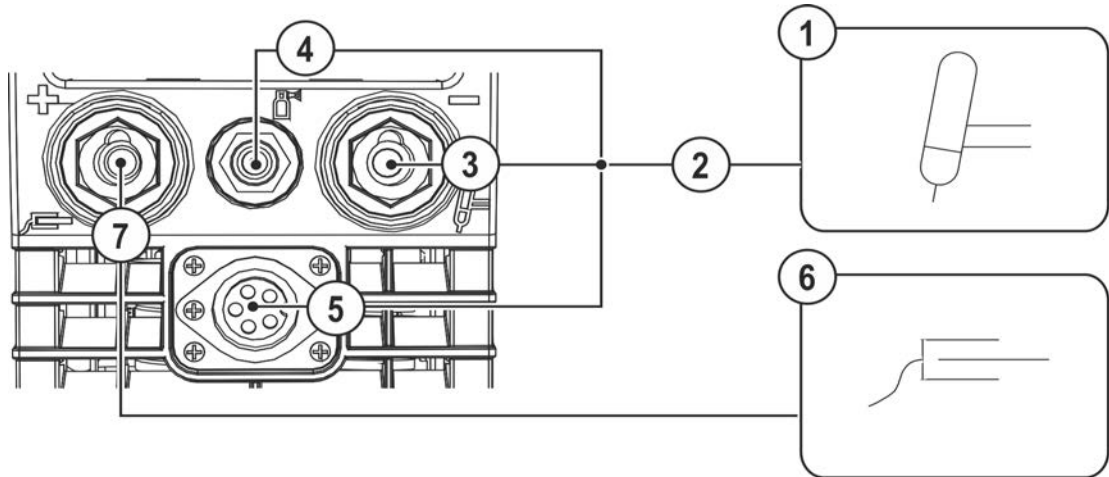

Figure 5-6

Item	Symbol	Description
1		Welding torch
2		Welding torch hose package
3		Connection socket, "-" welding current Welding current lead connection for TIG welding torch
4		Connection thread - G$\frac{1}{4}$" Shielding gas connection (outlet)
5		Connection socket (welding torch control cable) > see 5.2.1.1 chapter
6		Workpiece
7		Connection socket for "+" welding current Workpiece lead connection

- Insert the welding current plug on the welding torch into the welding current connection socket and lock by turning to the right.
- Remove yellow protective cap on G $\frac{1}{4}$ " connecting nipple.
- Screw welding torch shielding gas connection tightly onto the G $\frac{1}{4}$ " connection nipple.
- Plug the welding torch control cable plug into the welding torch control cable connection socket and secure.
- Insert the cable plug on the work piece lead into the "+" welding current connection socket and lock by turning to the right.

5.2.1.1 Control lead connection

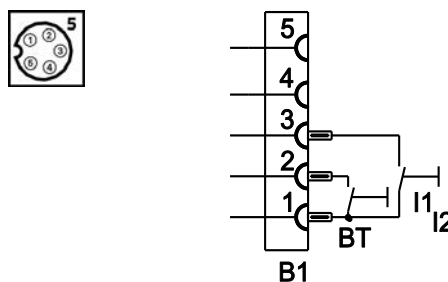

Figure 5-7

5.2.2 Shielding gas supply (shielding gas cylinder for welding machine)

⚠ WARNING



Risk of injury due to improper handling of shielding gas cylinders!
Improper handling and insufficient securing of shielding gas cylinders can cause serious injuries!

- Observe the instructions from the gas manufacturer and any relevant regulations concerning the use of compressed air!
- Do not attach any element to the shielding gas cylinder valve!
- Prevent the shielding gas cylinder from heating up.



An unhindered shielding gas supply from the shielding gas cylinder to the welding torch is a fundamental requirement for optimum welding results. In addition, a blocked shielding gas supply may result in the welding torch being destroyed.

- **Always re-fit the yellow protective cap when not using the shielding gas connection.**
- **All shielding gas connections must be gas tight.**

5.2.2.1 Pressure regulator connection

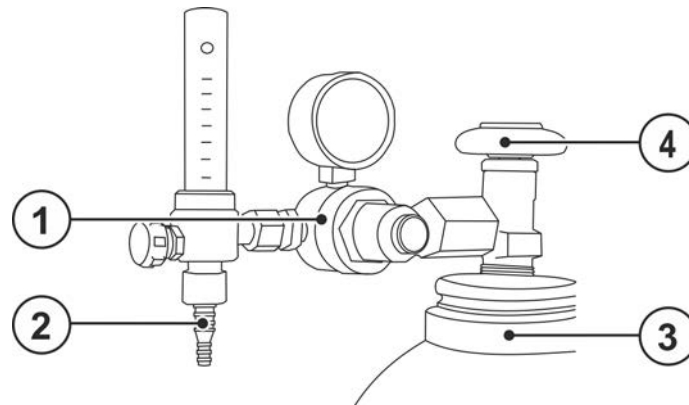

Figure 5-8

Item	Symbol	Description
1		Pressure regulator
2		Output side of the pressure regulator
3		Shielding gas cylinder
4		Cylinder valve

- Before connecting the pressure regulator to the gas cylinder, open the cylinder valve briefly to blow out any dirt.
- Tighten the pressure regulator screw connection on the gas bottle valve to be gas-tight.
- Screw the gas hose connection to the outlet side of the pressure regulator gas-tight.

5.2.2.2 Shielding gas hose connection

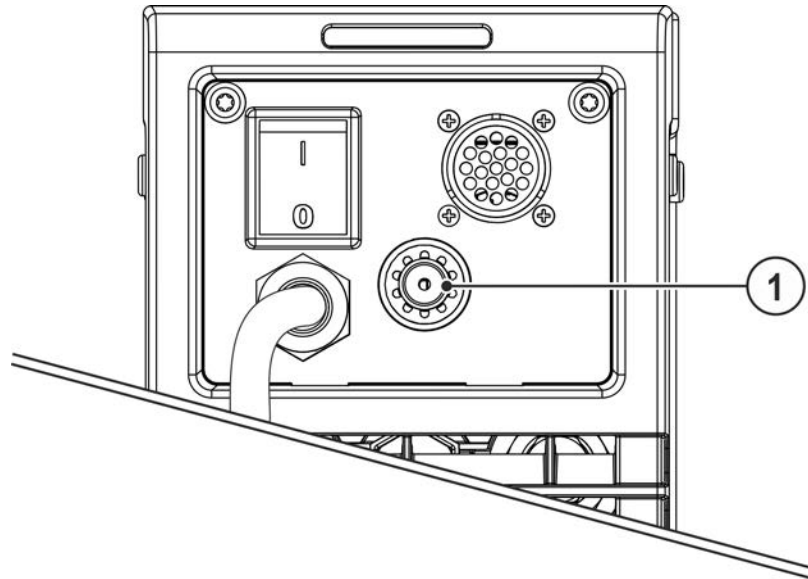

Figure 5-9

Item	Symbol	Description
1		Connection thread - G$\frac{1}{4}$" Shielding gas connection (inlet)

- Screw the gas hose connection nipple onto the G $\frac{1}{4}$ " connection nipple.

5.2.2.3 Gas test – setting the shielding gas volume

⚠ CAUTION

**Electric shocks!**

When setting the shielding gas quantity, high voltage ignition pulses or open circuit voltage are applied at the welding torch; these can lead to electric shocks and burning on contact.

- Keep the welding torch electrically insulated from persons, animals or equipment during the setting procedure.

If the shielding gas setting is too low or too high, this can introduce air to the weld pool and may cause pores to form. Adjust the shielding gas quantity to suit the welding task!

Rule of thumb for the gas flow rate:

Diameter of gas nozzle in mm corresponds to gas flow in l/min.

Example: 7mm gas nozzle corresponds to 7l/min gas flow.

- Press the torch trigger and set the shielding gas quantity with the flow gauge of the pressure regulator.

5.2.3 Arc ignition

To change the ignition type, use parameter \overline{hF} to switch between HF start (\overline{on}) and lift arc (\overline{off}) in the Expert menu > see 5.2.8 chapter.

5.2.3.1 HF ignition

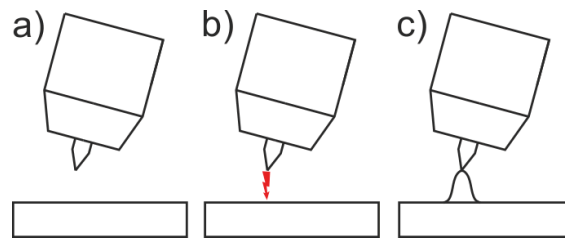

Figure 5-10

The arc is started without contact from high-voltage ignition pulses.

- Position the welding torch in welding position over the workpiece (distance between the electrode tip and workpiece should be approx. 2-3mm).
- Press the torch trigger (high voltage ignition pulses ignite the arc).
- Ignition current flows, and the welding process is continued depending on the operating mode selected.

End the welding process: Release or press the torch trigger depending on the operating mode selected.

5.2.3.2 Liftarc

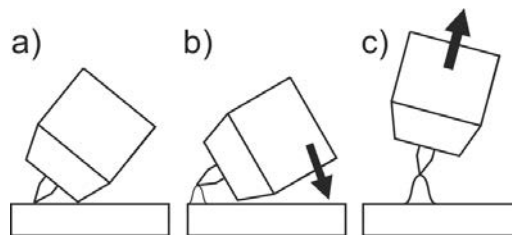

Figure 5-11

The arc is ignited on contact with the workpiece:

- Carefully place the torch gas nozzle and tungsten electrode tip onto the workpiece and press the torch trigger (liftarc current flowing, regardless of the main current set).
- Incline the torch over the torch gas nozzle to produce a gap of approx. 2-3 mm between the electrode tip and the workpiece. The arc ignites and the welding current is increased, depending on the operating mode set, to the ignition or main current set.
- Lift off the torch and swivel to the normal position.

Ending the welding process: Release or press the torch trigger depending on the operating mode selected.

5.2.3.3 Automatic cut-out

Once the fault periods have elapsed, the automatic cut-out stops the welding process when it has been triggered by one of two states:

- During ignition
5 s after the start of the welding process, no welding current flows (ignition error).
- During welding
The arc is interrupted for more than 3 s (arc interruption).

You can disable or set the time for re-ignition after an arc interruption in the machine configuration menu > see 5.6 chapter (parameter $\overline{I\bar{E}R}$).

5.2.4 Welding task selection

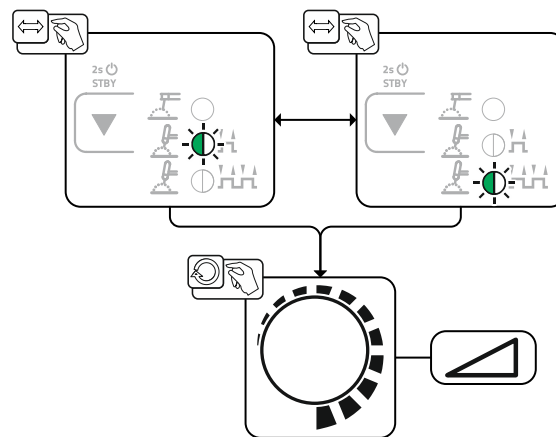

Figure 5-12

This completes the basic settings and you can now start welding.

Further welding parameters, such as gas pre-flow time, are predefined for the most common applications but can be adjusted when necessary > see 5.2.8 chapter.

5.2.5 Operating modes (functional sequences)

Using the welding parameter push-button and welding parameter setting rotary knob the sequence parameters are set.

By pressing the "select welding parameter" push-button for approx. 2 s you can access the advanced settings and optimise further parameters for your welding task > see 5.2.8 chapter.

5.2.5.1 Legend

Symbol	Meaning
	Gas pre-flow
	Ignition current
	Up-slope time
AMP	Main current
AMP%	Secondary current
t_{Down}	Down-slope time
	End-crater current
	Gas post-flow time
	Press torch trigger 1
	Release torch trigger 1
I	Welding current
t	Time

5.2.5.2 TIG non-latched operation

When the foot-operated remote control is connected, the machine switches automatically to non-latched operation. The up- and down-slopes are switched off.

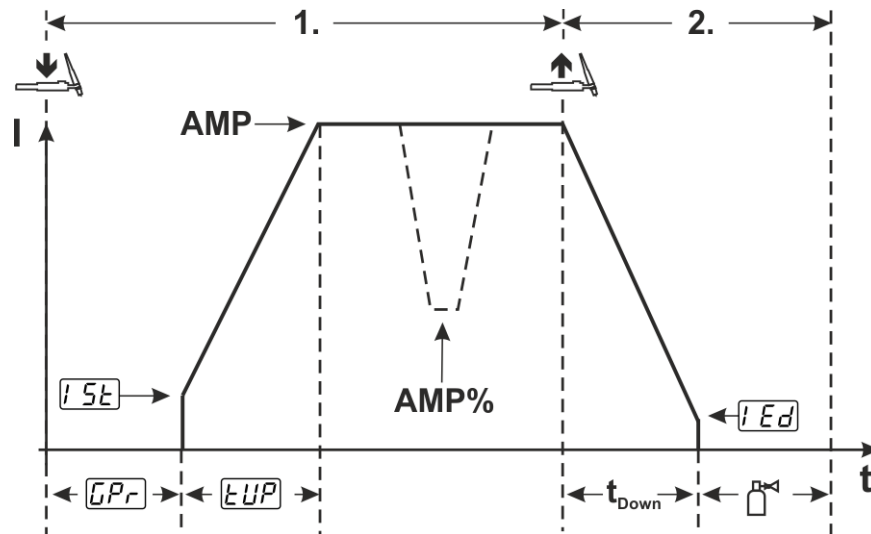

Figure 5-13

1st cycle:

- Press and hold torch trigger 1.
- Gas pre-flow time \overline{GPr} elapses.
- HF start pulses jump from the electrode to the workpiece. The arc ignites.
- The welding current flows and immediately assumes the value of the ignition current $\overline{i5t}$.
- HF switches off.
- The welding current ramps up to the main current AMP in the selected up-slope time \overline{tUP} .

If torch trigger 2 is pressed together with torch trigger 1 during the main current phase, the welding current decreases to the secondary current AMP%.

If torch trigger 2 is released, the welding current increases again to the main current AMP.

2nd cycle:

- Release torch trigger 1.
- The main current falls to the end-crater current \overline{iEd} (minimum current) in the set down-slope time.

If the 1st torch trigger is pressed during the down-slope time, the welding current returns to the set main current AMP.

- Main current reaches the end-crater current \overline{iEd} ; the arc is extinguished.
- Set gas post-flow time \overline{t} elapses.

5.2.5.3 TIG latched operation

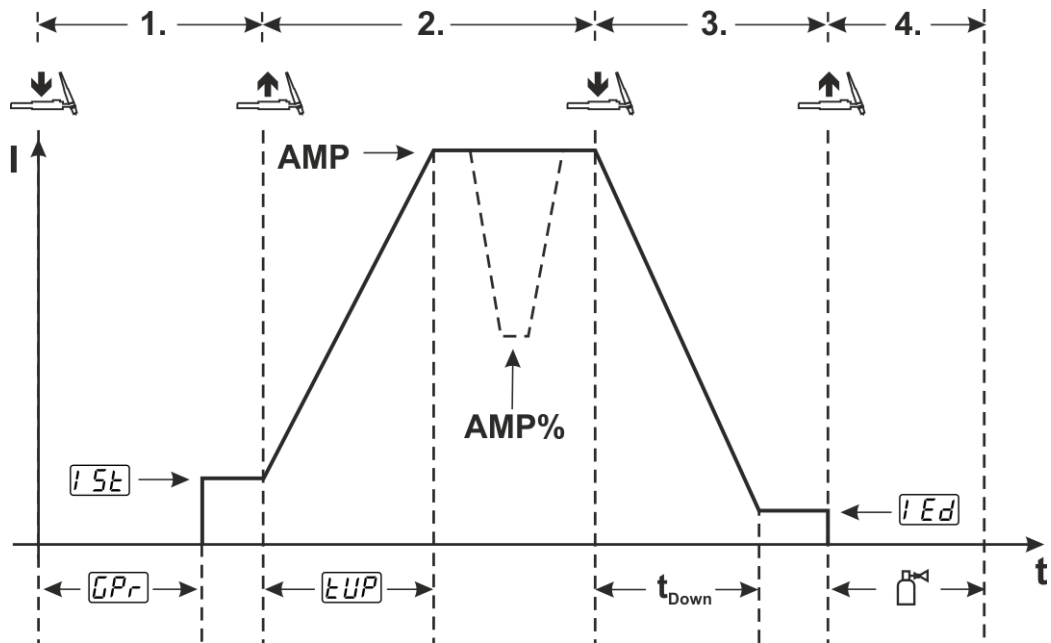

Figure 5-14

1st cycle

- Press torch trigger 1 \overline{GPr} , the gas pre-flow time elapses.
- HF start pulses jump from the electrode to the workpiece. The arc ignites.
- Welding current flows and immediately assumes the set ignition current $\overline{i5t}$ (search arc at minimum setting). HF switches off.

2nd cycle

- Release torch trigger 1.
- The welding current ramps up to the main current AMP in the selected \overline{tUP} .

Switching from the main current AMP to secondary current AMP%:

- Press torch trigger 2 or
- Tap torch trigger 1

The slope times can be set.

3rd cycle

- Press torch trigger 1.
- The main current falls to the end-crater current \overline{iEd} (minimum current) in the set down-slope time.

4th cycle

- Release torch trigger 1; arc is extinguished.
- Set gas post-flow time \overline{GPost} starts.

Ending the welding process immediately without a down-slope or end-crater current:

- Briefly press the 1st torch trigger (3rd and 4th cycle).
The current drops to zero and the gas post-flow time \overline{GPost} starts.

When the foot-operated remote control is connected, the machine switches automatically to non-latched operation. The up- and down-slopes are switched off.

A double-digit torch mode (11 x) needs to be set at the welding machine control to use the alternative welding start (tapping start). The number of torch modes available depends on the machine type.

5.2.6 Welding torch (operating variants)

Different torch versions can be used with this machine.

Functions on the operating elements, such as torch triggers (BRT), rockers or potentiometers, can be modified individually via torch modes.

Explanation of symbols for operating elements:

Symbol	Description
	Press torch trigger
	Tap torch trigger
	Tap and press torch trigger

5.2.6.1 Tapping function (tap torch trigger)

Tapping function: Swiftly tap the torch trigger to change the function. The set torch mode determines the operating mode.

5.2.6.2 Torch mode setting

Modes 1 to 3 and 11 to 13 are available to the user. Modes 11 to 13 feature the same functionality as 1 to 3, but without the tapping function > see 5.2.6.1 chapter for the secondary current.

The functionality of the individual modes can be found in the corresponding torch type tables.

The torch modes are set using the torch configuration parameters "`trd`" in the machine configuration menu > torch mode "`trd`" > see 5.6 chapter.

Only the modes listed are suitable for the corresponding torch types.

5.2.6.3 Up/down speed

Functionality

Press and hold the up push-button:

Increase current up to the maximum value (main current) set in the power source.

Press and hold the down push-button:

Decrease current to the minimum value.

Use the machine configuration menu > see 5.6 chapter to set the up/down speed parameter `u/d` which determines the speed with which a current change becomes effective.

5.2.6.4 Standard TIG torch (5-pole)

Standard torch with one torch trigger

Figure	Operating elements	Explanation of symbols
		BRT1 = torch trigger 1 (welding current on/off; secondary current via tapping function)
Functions	Mode	Operating elements
Welding current on/off	1 (ex works)	
Secondary current (latched operation)		













Standard torch with two torch triggers

Figure	Operating elements	Explanation of symbols
		BRT1 = torch trigger 1 BRT2 = torch trigger 2
Functions	Mode	Operating elements
Welding current on/off	1 (ex works)	
Secondary current		
Secondary current (tapping function) ¹ /(latched operating mode)		
Welding current on/off	3	
Secondary current (tapping function) ¹ /(latched operating mode)		
Up function ²		
Down function ²		

¹ > see 5.2.6.1 chapter

² > see 5.2.6.3 chapter

Standard torch with one rocker (rocker, two torch triggers)

Figure	Operating elements	Explanation of symbols
		BRT 1 = torch trigger 1 BRT 2 = torch trigger 2
Functions	Mode	Operating elements
Welding current on/off	1 (ex works)	
Secondary current		
Secondary current (tapping function ¹)/(latched operating mode)		
Welding current on/off	2	
Secondary current (tapping function ¹)		
Up function ²		
Down function ²		
Welding current on/off	3	
Secondary current (tapping function ¹)/(latched operating mode)		
Up function ²		
Down function ²		

¹ > see 5.2.6.1 chapter

² > see 5.2.6.3 chapter

5.2.7 Average value pulse welding

Average value pulse welding means that two currents are switched periodically, a current average value (AMP), a pulse current (I_{puls}), a balance (bRL) and a frequency (FrE) having been defined first. The predefined ampere current average value is decisive, the pulse current (I_{puls}) is defined by the IPL parameter as a percentage of the current average value (AMP). The pulse pause current (IPP) requires no setting. This value is calculated by the machine control, so that the welding current average value (AMP) is maintained at all times.

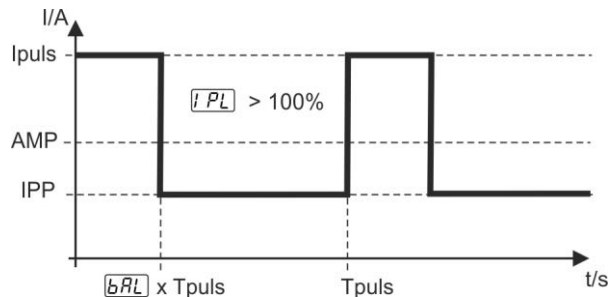

Figure 5-15

AMP = Main current; e.g. 100 A

I_{puls} = Pulse current = $IPL \times AMP$; e.g. 140% x 100 A = 140 A

IPP = Pulse pause current

$Tpuls$ = Duration of one pulse cycle = $1/FrE$; e.g. 1/1 Hz = 1 s

bRL = Balance

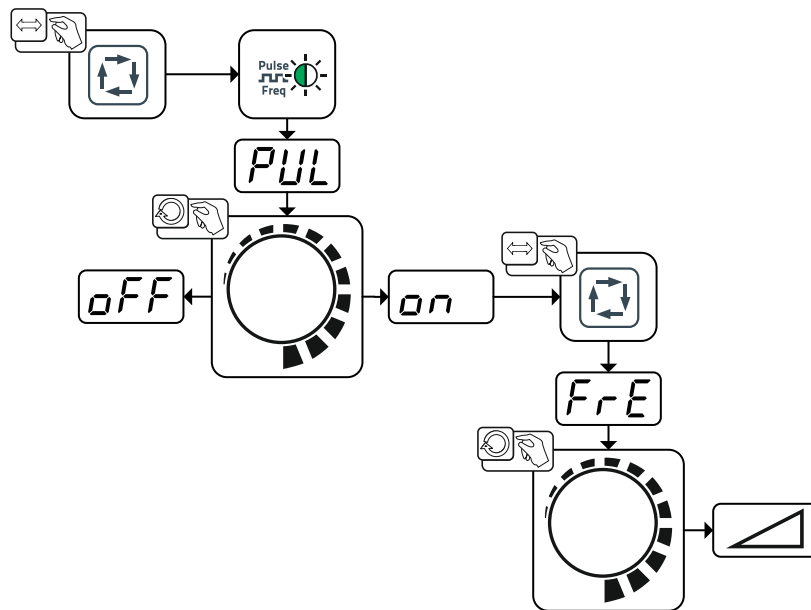

Figure 5-16

Display	Setting/selection
PUL	Pulse welding (average value pulses) on ----- Function switched on off ----- Function switched off (ex works)
FrE	Pulse frequency

More parameters can be set in the Expert menu > see 5.2.8 chapter.

5.2.8 Expert menu (TIG)

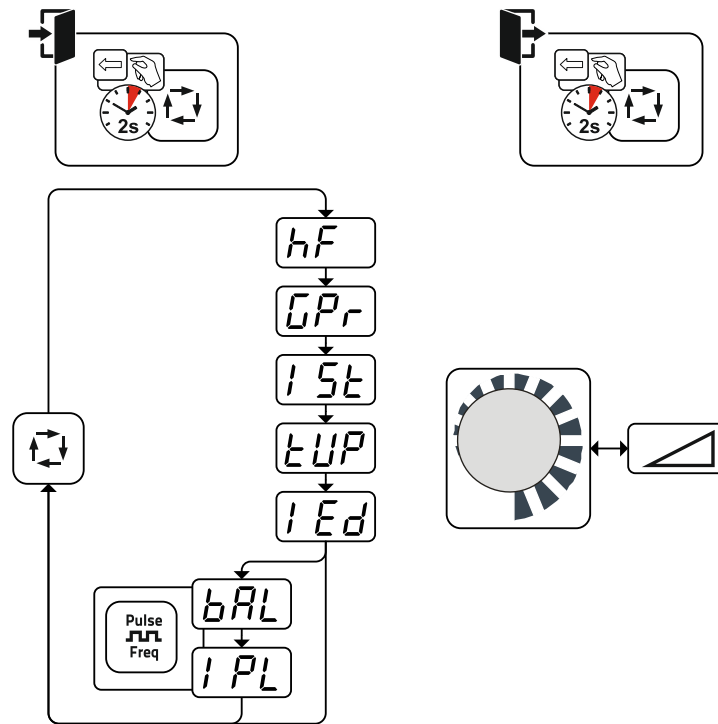

Figure 5-17

Display	Setting/selection
HF	Switch ignition mode <input type="checkbox"/> on HF ignition <input type="checkbox"/> OFF Liftarc
GPr	Gas pre-flow time
ISt	Ignition current (as percentage, dependent on main current)
tUP	Upslope time to main current
IEd	End-crater current Setting range in percent: depending on main current Setting range, absolute: Imin to Imax.
bAL	Pulse balance
I PL	Pulse current > see 5.2.7 chapter

5.3 MMA welding

5.3.1 Connecting the electrode holder and workpiece lead

⚠ CAUTION



Risk of crushing and burns!

When changing stick electrodes there is a risk of crushing and burns!

- Wear appropriate and dry protective gloves.
- Use an insulated pair of tongs to remove the used stick electrode or to move welded workpieces.

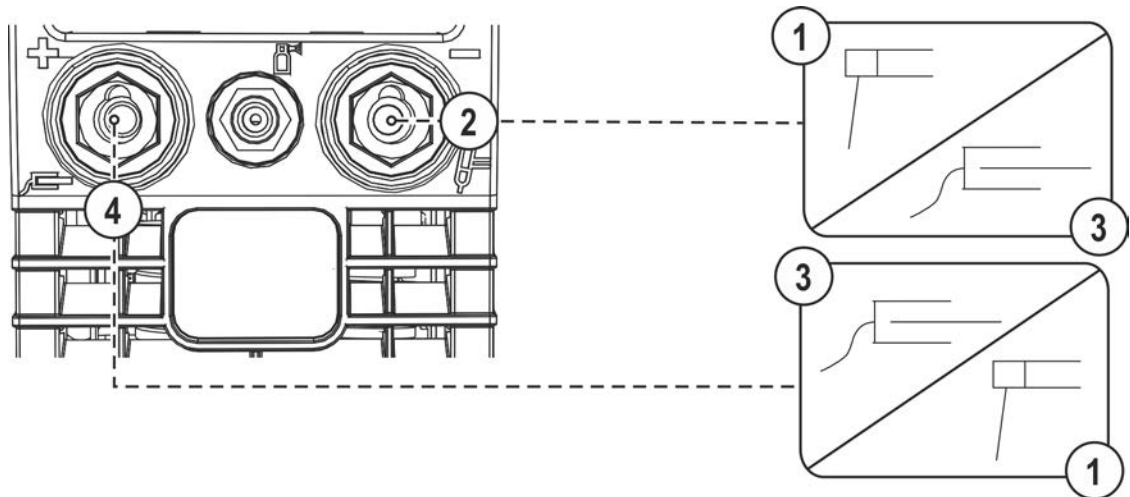

Figure 5-18

Item	Symbol	Description
1		Electrode holder
2		Connection socket, "-" welding current Workpiece lead or electrode holder connection
3		Workpiece
4		Connection socket for "+" welding current Electrode holder or workpiece lead connection

- Insert the electrode holder plug and workpiece lead into the welding current socket depending on application and lock in place by turning to the right. The corresponding polarity will be based on the information of the electrode manufacturer on the electrode packaging.

5.3.2 Welding task selection

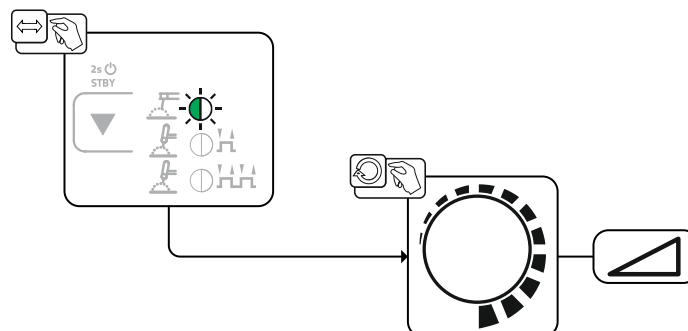

Figure 5-19

This completes the basic settings and you can now start welding.

The optimum values for hot start current, hot start time and arcforcing are predefined ex works, but can be adjusted when necessary > see 5.3.7 chapter.

5.3.3 Hotstart

The function hot start ensures a secure igniting of the arc and a sufficient heating to the still cold parent metal at the beginning of the welding process. The ignition takes place here with increased current (hot start current) over a certain time (hot start time).

For parameter setting, > see 5.3.7 chapter.

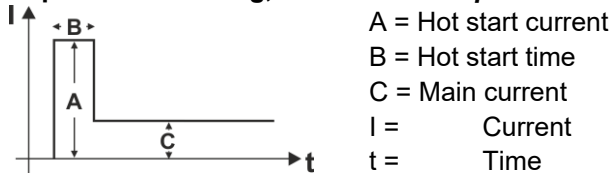

Figure 5-20

5.3.4 Arcforce

During the welding process, arcforce prevents the electrode sticking in the weld pool with increases in current. This makes it easier to weld large-drop melting electrode types at low current strengths with a short arc in particular.

For parameter setting, > see 5.3.7 chapter.

5.3.5 Antistick

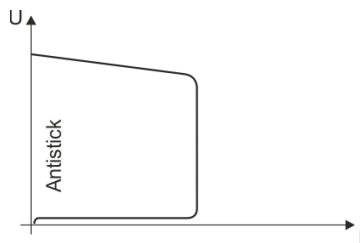

The Antistick feature prevents the electrode from annealing.

Should the electrode stick despite the Arcforce feature, the machine automatically switches to the minimum current within approx. one second. This prevents the electrode from annealing. Check the welding current setting and correct for the welding task in hand.

Figure 5-21

5.3.6 Average value pulse welding

Average value pulse welding means that two currents are switched periodically, a current average value (AMP), a pulse current (Ipuls), a balance (\overline{bRL}) and a frequency (\overline{FrE}) having been defined first. The predefined ampere current average value is decisive, the pulse current (Ipuls) is defined by the \overline{IPL} parameter as a percentage of the current average value (AMP). The pulse pause current (IPP) requires no setting. This value is calculated by the machine control, so that the welding current average value (AMP) is maintained at all times.

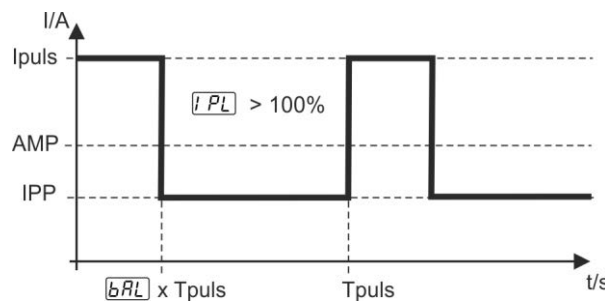

Figure 5-22

AMP = Main current; e.g. 100 A

Ipuls = Pulse current = \overline{IPL} x AMP; e.g. 140% x 100 A = 140 A

IPP = Pulse pause current

Tpuls = Duration of one pulse cycle = $1/\overline{FrE}$; e.g. 1/1 Hz = 1 s

\overline{bRL} = Balance

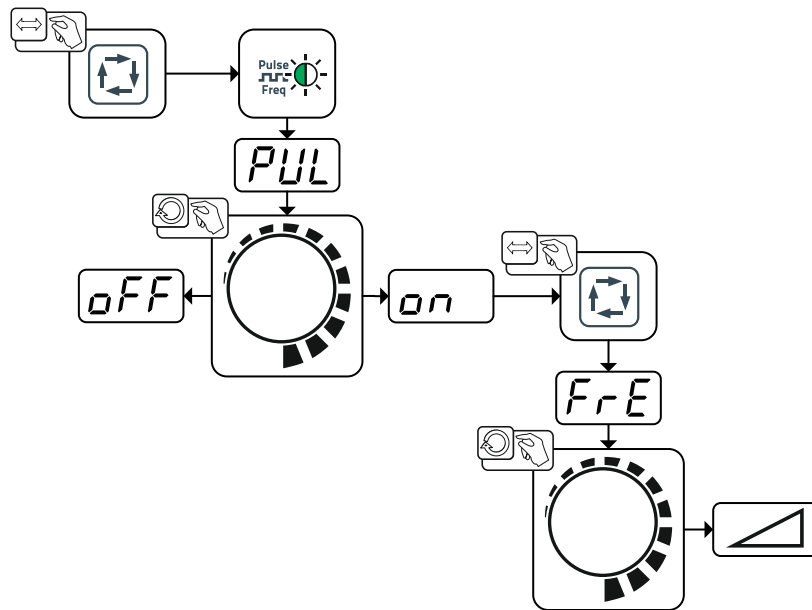

Figure 5-23

Display	Setting/selection
PUL	Pulse welding (average value pulses) on ----- Function switched on OFF ----- Function switched off (ex works)
FrE	Pulse frequency

More parameters can be set in the Expert menu > see 5.3.7 chapter.

5.3.7 Expert menu (MMA)

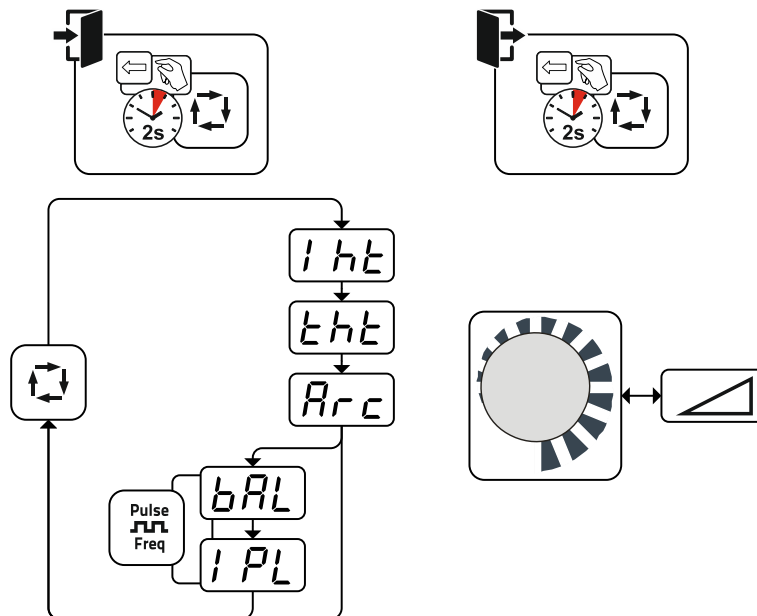
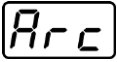

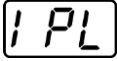

Figure 5-24

Display	Setting/selection
1ht	Hotstart current
2ht	Hotstart time

Display	Setting/selection
	Arcforce correction <ul style="list-style-type: none"> • Increase value > harder arc • Decrease value > softer arc
	Pulse balance
	Pulse current > see 5.3.6 chapter

5.4 Remote control

The remote controls are operated on the 19-pole remote control connection socket (analogue).

5.4.1 RTF1 19POL

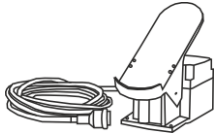

Functions

- Infinitely adjustable welding current (0% to 100%) depending on the preselected main current on the welding machine.
- Start/stop welding operation (TIG)

5.4.2 RT1 19POL



Functions

- Infinitely adjustable welding current (0% to 100%) depending on the preselected main current on the welding machine.

5.5 Power-saving mode (Standby)

You can activate the power-saving mode by either pressing the push-button > see 4.3 chapter for a prolonged time or by setting a parameter in the machine configuration menu (time-controlled power-saving mode ) > see 5.6 chapter.



When power-saving mode is activated, the machine displays show the horizontal digit in the centre of the display only.

Pressing any operating element (e.g. turning a rotary knob) deactivates power-saving mode and the machine is ready for welding again.

5.6 Machine configuration menu

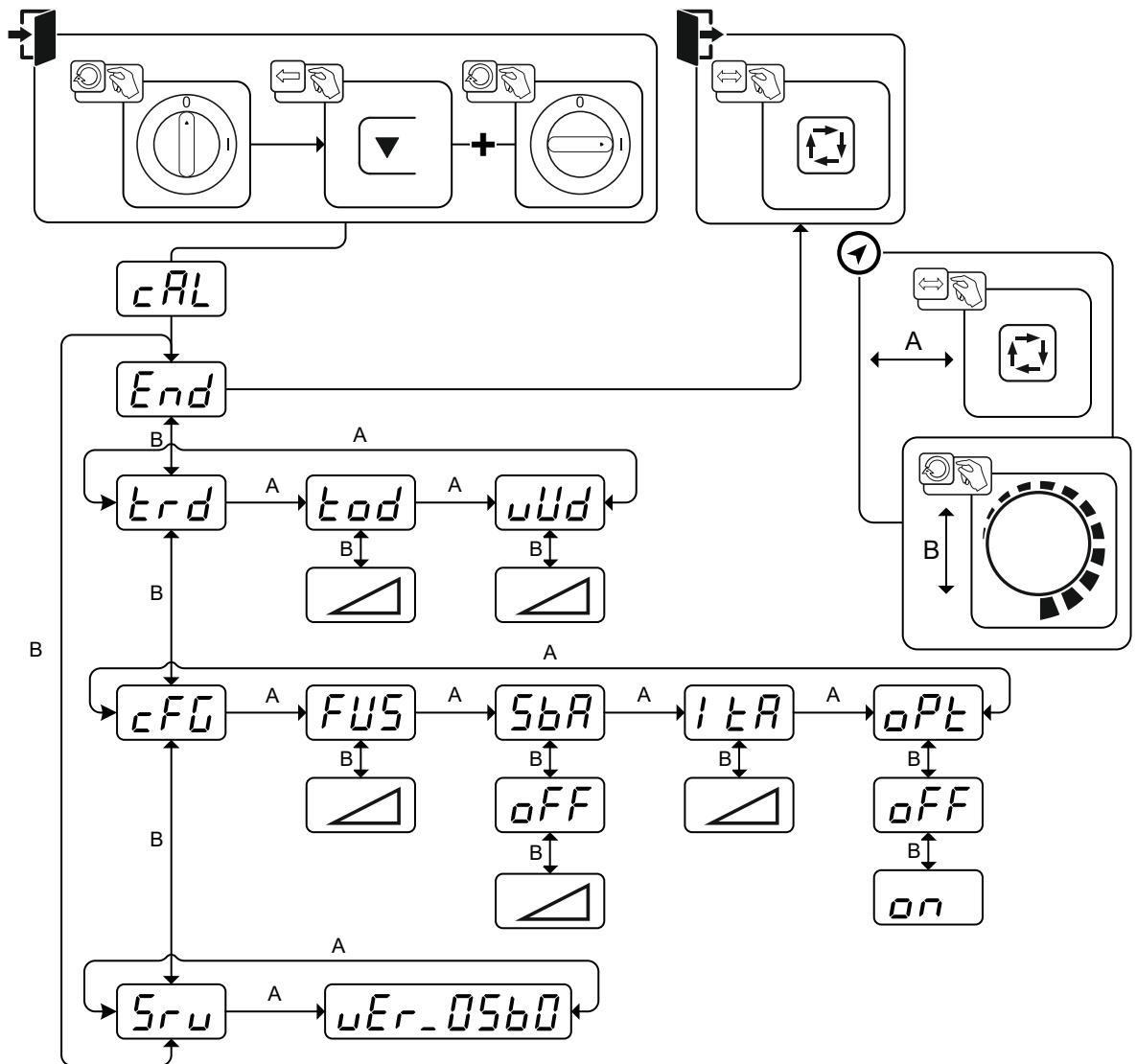
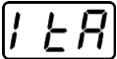

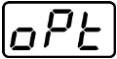

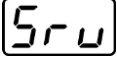
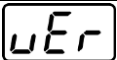

Figure 5-25

Display	Setting/selection
	Calibration The machine will be calibrated for approx 2 seconds each time it is switched on.
	Exit the menu Exit
	Torch configuration menu Set welding torch functions
	Torch mode (ex works 1) > see 5.2.6.2 chapter
	Up/down speed > see 5.2.6.3 chapter Increase value > rapid current change Decrease value > slow current change
	Machine configuration Settings for machine functions and parameter display
	Dynamic power adjustment > see 7.5 chapter
	Time-based power-saving mode > see 5.5 chapter Time to activation of the power-saving mode in case of inactivity. Setting = disabled or numerical value 5-60 min..

Display	Setting/selection
	Re-ignition after arc interruption > see 5.2.3.3 chapter  ----- Function switched off or time setting
	Arc detection for welding helmets (TIG) Modulated waviness for better arc detection  ----- Function enabled  ----- Function disabled
	Service menu Any changes to the service menu should be agreed with the authorised service personnel.
	Software version of the machine control Version display

6 Maintenance, care and disposal

6.1 General

DANGER



Risk of injury due to electrical voltage after switching off!

Working on an open machine can lead to fatal injuries!

Capacitors are loaded with electrical voltage during operation. Voltage remains present for up to four minutes after the mains plug is removed.

1. Switch off machine.
2. Remove the mains plug.
3. Wait for at last 4 minutes until the capacitors have discharged!

WARNING



Incorrect maintenance, testing and repair!

Maintenance, testing and repair of the machine may only be carried out by skilled and qualified personnel. A qualified person is one who, because of his or her training, knowledge and experience, is able to recognise the dangers that can occur while testing welding power sources as well as possible subsequent damage, and who is able to implement the required safety procedures.

Observe the maintenance instructions > see 6.2 chapter.

- In the event that the provisions of one of the below-stated tests are not met, the machine must not be operated again until it has been repaired and a new test has been carried out!

Repair and maintenance work may only be performed by qualified authorised personnel; otherwise the right to claim under warranty is void. In all service matters, always consult the dealer who supplied the machine. Return deliveries of defective equipment subject to warranty may only be made through your dealer. When replacing parts, use only original spare parts. When ordering spare parts, please quote the machine type, serial number and item number of the machine, as well as the type designation and item number of the spare part.

Under the specified ambient conditions and normal working conditions this machine is essentially maintenance-free and requires just a minimum of care.

Contamination of the machine may impair service life and duty cycle. The cleaning intervals depend on the ambient conditions and the resulting contamination of the machine. The minimum interval is every six months.

6.1.1 Cleaning

- Clean the outer surfaces with a moist cloth (no aggressive cleaning agents).
- Purge the machine venting channel and cooling fins (if present) with oil- and water-free compressed air. Compressed air may overspeed and destroy the machine fans. Never direct the compressed air directly at the machine fans. Mechanically block the fans, if required.
- Check the coolant for contaminants and replace, if necessary.

6.1.2 Dirt filter

When using a dirt filter, the cooling air throughput is reduced and the duty cycle of the machine is reduced as a result. The duty cycle decreases with the increasing contamination of the filter. The dirt filter must be removed at regular intervals and cleaned by blowing out with compressed air (depending on the level of soiling).

6.2 Maintenance work, intervals

6.2.1 Daily maintenance tasks

Visual inspection

- Mains supply lead and its strain relief
- Gas cylinder securing elements
- Check hose package and power connections for exterior damage and replace or have repaired by specialist staff as necessary!
- Gas tubes and their switching equipment (solenoid valve)
- Check that all connections and wearing parts are hand-tight and tighten if necessary.
- Check correct mounting of the wire spool.
- Wheels and their securing elements
- Transport elements (strap, lifting lugs, handle)
- Other, general condition

Functional test

- Operating, message, safety and adjustment devices (Functional test)
- Welding current cables (check that they are fitted correctly and secured)
- Gas tubes and their switching equipment (solenoid valve)
- Gas cylinder securing elements
- Check correct mounting of the wire spool.
- Check that all screw and plug connections and replaceable parts are secured correctly, tighten if necessary.
- Remove any spatter.
- Clean the wire feed rollers on a regular basis (depending on the degree of soiling).

6.2.2 Monthly maintenance tasks

Visual inspection

- Casing damage (front, rear and side walls)
- Wheels and their securing elements
- Transport elements (strap, lifting lugs, handle)
- Check coolant tubes and their connections for impurities

Functional test

- Selector switches, command devices, emergency stop devices, voltage reducing devices, message and control lamps
- Check wire guide elements (wire feed roll holder, wire feed nipple, wire guide tube) for tight fit. Recommendation for replacing the wire feed roll holder (eFeed) after 2000 hours of operation, see replacement parts).
- Check coolant tubes and their connections for impurities
- Check and clean the welding torch. Deposits in the torch can cause short circuits and have a negative impact on the welding result, ultimately causing damage to the torch.

6.2.3 Annual test (inspection and testing during operation)

A periodic test according to IEC 60974-4 "Periodic inspection and test" has to be carried out. In addition to the regulations on testing given here, the relevant local laws and regulations must also be observed.

For more information refer to the "Warranty registration" brochure supplied and our information regarding warranty, maintenance and testing at www.ewm-group.com!

6.3 Disposing of equipment



Proper disposal!

The machine contains valuable raw materials, which should be recycled, and electronic components, which must be disposed of.

- Do not dispose of in household waste!
- Observe the local regulations regarding disposal!
- According to European provisions (Directive 2012/19/EU on Waste of Electrical and Electronic Equipment), used electric and electronic equipment may no longer be placed in unsorted municipal waste. It must be collected separately. The symbol depicting a waste container on wheels indicates that the equipment must be collected separately.
This machine has to be disposed of, or recycled, in accordance with the waste separation systems in use.
- According to German law (law governing the distribution, taking back and environmentally correct disposal of electric and electronic equipment (ElektroG)), used machines are to be placed in a collection system separate from unsorted municipal waste. The public waste management utilities (communities) have created collection points at which used equipment from private households can be disposed of free of charge.
- Information about returning used equipment or about collections can be obtained from the respective municipal administration office.
- In addition to this, returns are also possible throughout Europe via EWM sales partners.

7 Rectifying faults

All products are subject to rigorous production checks and final checks. If, despite this, something fails to work at any time, please check the product using the following flowchart. If none of the fault rectification procedures described leads to the correct functioning of the product, please inform your authorised dealer.

7.1 Checklist for rectifying faults

The correct machine equipment for the material and process gas in use is a fundamental requirement for perfect operation!

Legend	Symbol	Description
	↘	Fault/Cause
	✘	Remedy

Mains fuse triggers

- ↘ Mains fuse triggers - unsuitable mains fuse
- ✘ Set up recommended mains fuse > see 8 chapter.

Functional errors

- ↘ Several parameters cannot be set (machines with access block)
 - ✘ Entry level is blocked, disable access lock
- ↘ All machine control signal lights are illuminated after switching on
- ↘ No machine control signal light is illuminated after switching on
- ↘ No welding power
 - ✘ Phase failure > check mains connection (fuses)
- ↘ Connection problems
 - ✘ Make control lead connections and check that they are fitted correctly.
- ↘ Loose welding current connections
 - ✘ Tighten power connections on the torch and/or on the workpiece
 - ✘ Tighten contact tip correctly

No arc ignition

- ↘ Incorrect ignition type setting.
 - ✘ Ignition type: Select "HF start". Depending on the machine, the setting is defined by the change-over switch for ignition types or the hF parameter in one of the machine menus (see the "Control operating instructions", if applicable).

Bad arc ignition

- ↘ Material inclusions in the tungsten electrode due to contact with filler material or workpiece
 - ✘ Regrind or replace the tungsten electrode
- ↘ Bad current transfer on ignition
 - ✘ Check the setting on the "Tungsten electrode diameter/Ignition optimisation" rotary dial and increase if necessary (higher ignition energy).

Welding torch overheated

- ↘ Loose welding current connections
 - ✘ Tighten power connections on the torch and/or on the workpiece
 - ✘ Tighten contact tip correctly
- ↘ Overload
 - ✘ Check and correct welding current setting
 - ✘ Use a more powerful welding torch

Unstable arc



- ✓ Material inclusions in the tungsten electrode due to contact with filler material or workpiece
 - ✗ Regrind or replace the tungsten electrode
- ✓ Incompatible parameter settings
 - ✗ Check settings and correct if necessary

Pore formation

- ✓ Inadequate or missing gas shielding
 - ✗ Check shielding gas setting and replace shielding gas cylinder if necessary
 - ✗ Shield welding site with protective screens (draughts affect the welding result)
 - ✗ Use gas lens for aluminium applications and high-alloy steels
- ✓ Unsuitable or worn welding torch equipment
 - ✗ Check size of gas nozzle and replace if necessary
- ✓ Condensation (hydrogen) in the gas tube
 - ✗ Purge hose package with gas or replace

7.2 Error messages (power source)

Depending on the options of the machine display, a fault is shown as follows:

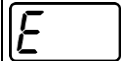
Display type - machine control	Display
Graphic display	
two 7-segment displays	
one 7-segment display	

The possible cause of the fault is signalled by a corresponding fault number (see table). In the case of an error, the power unit shuts down.

The display of possible error numbers depends on the machine version (interfaces/functions).

- Document machine errors and inform service staff as necessary.
- If multiple errors occur, these are displayed in succession.

Error message	Possible cause	Remedy
E 0	Start signal set in the event of errors	Do not press the torch trigger or the foot-operated remote control
E 4	Temperature error	Allow the machine to cool down
E 5	Mains overvoltage	Switch off the machine and check the mains voltage
E 6	Mains undervoltage	
E 7	Electronics error	Switch the machine off and on again. If the error persists, notify service department
E 9	Secondary overvoltage	
E12	Voltage reduction error (VRD)	
E13	Electronics error	
E14	Adjustment error in current recording	Switch off the machine, place the electrode holder in an insulated position and switch the machine back on. If the error persists, notify service department
E15	Error in one of the electronics supply voltages	Switch the machine off and on again. If the error persists, notify service department
E23	Temperature error	Allow the machine to cool down
E32	Electronics error	Switch the machine off and on again. If the error persists, notify service department
E33	Adjustment error in voltage recording	Switch off the machine, place the electrode holder in an insulated position and switch the machine back on. If the error persists, notify service department
E34	Electronics error	Switch the machine off and on again. If the error persists, notify service department
E37	Temperature error	Allow the machine to cool down
E40	Motor fault	Check wire feed mechanism, switch the machine off and on again, inform the service department if the fault persists.
E51	Earth fault (PE error)	Connection between welding wire and machine casing
E55	Failure of a mains phase	Switch off the machine and check the mains voltage
E58	Short circuit in welding circuit	Switch off the machine and check welding current leads for correct installation, e.g. by placing the electrode holder in an insulated position; detach current lead from degaussing.

7.3 Resetting welding parameters to the factory settings

All customised welding parameters that are stored will be replaced by the factory settings.

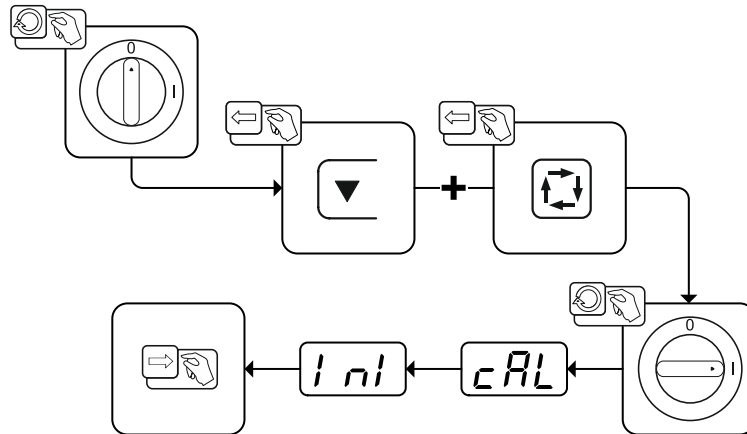

Figure 7-1

Display	Setting/selection
	Calibration The machine will be calibrated for approx 2 seconds each time it is switched on.
	Initialising Keep the push-button pressed until is shown on the display.
	Input confirmation User entries are applied, release button(s).

7.4 Display machine control software version

The query of the software versions only serves to inform the authorised service staff. It is available in the machine configuration menu > see 5.6 chapter.

7.5 Dynamic power adjustment

This requires use of the appropriate mains fuse.

Observe mains fuse specification > see 8 chapter!

This function enables aligning the machine to the mains connection fusing to avoid continuous tripping of the mains fuse. The maximum power input of the machine is limited by an exemplary value for the existing mains fuse (several levels available).

You can predefine this value in the machine configuration menu > see 5.6 chapter using parameter . The selected value will be shown on the machine display for two seconds after the machine has been switched on.

The function automatically adjusts the welding power to an uncritical level for the mains fuse.



When using a 20-A mains fuse, a suitable mains plug has to be installed by a qualified electrician.

8 Technical data

Performance specifications and guarantee only in connection with original spare and replacement parts!

8.1 Picotig 200

	TIG	MMA
Welding current (I ₂)	5 A to 200 A	5 A to 150 A
Welding voltage according to standard (U ₂)	10,2 V to 18,0 V	20,2 V to 26,0 V
Duty cycle DC at 40° C ^[1]	200 A (25 %) 150 A (60 %) 140 A (100 %)	150 A (35 %) 120 A (60 %) 100 A (100 %)
Open circuit voltage (U ₀)	90 V	
Mains voltage (Tolerance)	1 x 230 V (-40 % to +15 %)	
Frequency	50/60 Hz	
mains fuse ^[2]	1 x 16 A	
Mains connection cable	H07RN-F3G2,5	
max. Connected load (S ₁)	6,0 kVA	6,4 kVA
Rec. Generator rating	8,6 kVA	
Cos φ / efficiency	0,99 / 86 %	
Protection class	I	
Overvoltage category	III	
Contamination level	3	
Insulation class / protection classification	H / IP 23	
Residual current circuit breaker	Type B (recommended)	
Noise level ^[3]	<70 dB(A)	
Ambient temperature	-25 °C to +40 °C	
Machine cooling	Fan (AF)	
Torch cooling	gas	
Workpiece lead (min.)	35 mm ²	
EMC class	A	
Safety marking	□ / CE / ENEC	
Standards used	See declaration of conformity (appliance documents)	
Dimensions (l x b x h)	428 x 136 x 252 mm 16.9 x 5.4 x 9.9 inch	
Weight	8 kg 17.6 lb.	

^[1] Load cycle: 10 min. (60 % DC \pm 6 min. welding, 4 min. pause)

^[2] Safety fuses are recommended DIAZED xxA gG. When using automatic cutouts, the "C" trigger characteristic must be used.

^[3] Noise level during idle mode and operation under standard load according to IEC 60974- 1 at the maximum operating point.

9 Accessories

Performance-dependent accessories like torches, workpiece leads, electrode holders or intermediate hose packages are available from your authorised dealer.

9.1 Transport system

Type	Designation	Item no.
Trolly 35-1	Transport vehicle	090-008629-00000

9.2 Options

Type	Designation	Item no.
ON Filter T.0003	Dirt filter for air inlet	092-002546-00000
ON Safeguard T.0003	Insulating protective cover	092-008767-00000

9.3 Remote controls and accessories

Type	Designation	Item no.
RT1 19POL	Remote control current	090-008097-00000
RTF1 19POL 5 M	Foot-operated remote control current with connection cable	094-006680-00000
RA5 19POL 5M	Remote control e.g. connection cable	092-001470-00005
RA10 19POL 10m	Remote control e.g. connection cable	092-001470-00010
RA20 19POL 20m	Remote control e.g. connection cable	092-001470-00020
RV5M19 19POLE 5M	Extension cable	092-000857-00000











9.4 General accessories

Type	Designation	Item no.
DM 842 Ar/CO2 230bar 30l D	Pressure regulator with manometer	394-002910-00030
GH 2X1/4" 2M	Gas hose	094-000010-00001
ADAP CEE16/SCHUKO	Earth contact coupling/CEE16A plug	092-000812-00000







10 Appendix

10.1 Parameter overview – setting ranges

10.1.1 TIG welding

Welding data display	Parameters/function	Setting range				
		Standard (factory set)	min.		max.	Unit
	Secondary current AMP%	50	1	-	200	A
	Down-slope time	1	0,0	-	20	s
	Gas post-flow time	4	0,0	-	20	s
	Pulse welding	off	off	-	on	
	Pulse frequency	2,8	0,2	-	2000	Hz
	HF start	on	off	-	on	
	Gas pre-flow time	0,5	0,0	-	5	s
	Ignition current	20	1	-	200	%
	Up-slope time	1,0	0,0	-	20,0	s
	End-crater current AMP%	20	1	-	200	%
	Pulse balance	50	1	-	99	%
	Pulse current	140	1	-	200	%

10.1.2 MMA welding

Welding data display	Parameters/function	Setting range				
		Standard (ex works)	Min.		Max.	Unit
	Pulse welding	off	off	-	on	
	Pulse frequency	1,2	0,2	-	500	Hz
	Hot start current (AMP%)	120	50	-	200	%
	Hot start time	0,5	0,1	-	20,0	s
	Arcforce correction	0	-10	-	10	
	Pulse balance	30	1	-	99	%
	Pulse current	142	1	-	200	%

10.1.3 Basic parameters (independent of process)

Welding data display	Parameters/function	Setting range				
		Standard (factory set)	min.		max.	Unit
<input type="checkbox"/> on	Switched on					
<input type="checkbox"/> off	Switched off					
<input type="checkbox"/> cRL	Calibration					
<input type="checkbox"/> i n l	Initialisation					
<input type="checkbox"/> cFG	Machine configuration					
<input type="checkbox"/> End	Exit menu					
<input type="checkbox"/> Er d	Torch configuration					
<input type="checkbox"/> E o d	Torch mode	1	1	-	13	
<input type="checkbox"/> u u d	Up/down speed	10	1	-	100	
<input type="checkbox"/> S r u	Service menu					
<input type="checkbox"/> u E r	Software version of the machine control					
<input type="checkbox"/> F U S	Dynamic power adjustment (10 A, 16 A, 20 A)	16	10	-	20	A
<input type="checkbox"/> S b A	Time-based power-saving mode	20	off	-	60	min.
<input type="checkbox"/> I E A	Re-ignite after arc interruption	3,0	off		5,0	s
<input type="checkbox"/> a P t	Arc detection for welding helmets (TIG)	off	off	-	on	
<input type="checkbox"/> -	Power-saving mode is active					

10.2 Searching for a dealer

Sales & service partners
www.ewm-group.com/en/specialist-dealers



"More than 400 EWM sales partners worldwide"